

ASA DENTAL



DENTAL CATALOG 2025

INDEX

CATALOG 2025



01-12
COMPANY



13-00
SCIENTIFIC NAME
INDEX



A01-A19
ASAONE



B01-B25
DIAGNOSTICS



C01-C47
ORAL SURGERY



D01-D73
EXTRACTIVE SURGERY



E01-E41
IMPLANT SURGERY



F01-F53
RESTORATIVE



G01-L19
ENDODONTICS



H01-G37
PERIODONTAL



I01-H37
ORTHODONTICS

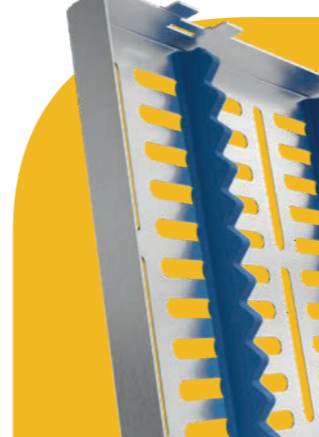

J01-I17
INSTRUMENT CASSETTES
AND TRAYS



K01-J49
IMPRESSION TRAYS



L01-K35
LABORATORY
INSTRUMENTS



00-00
CODE INDEX



00-00
NAME INDEX

1961



FOUNDATION

The intuition of Aldo Puccetti becomes a company: Asa Dental is born

1965

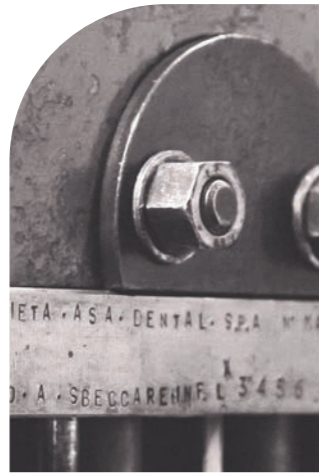

MANIAGO

The Maniago production plant opens. Stainless steel instruments complement the disposables offer

1975

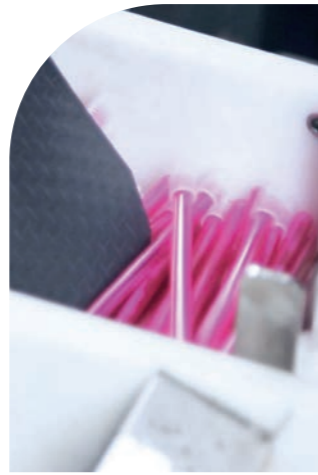

MARLIA

The plant in Marlia starts production to meet increasing market demand

2001



DERBY DENTAL

Asa Dental acquires Derby Dental and extends its product portfolio

2004

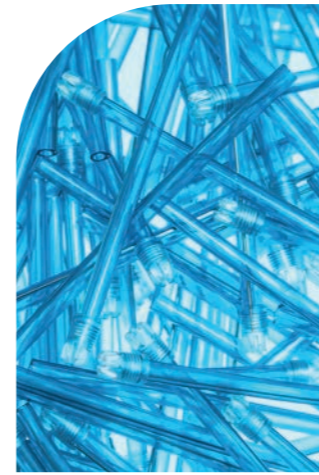

KALTOPLAST

Asa Dental's acquisition of Kaltoplast consolidates the company's leading position as a disposable saliva ejector manufacturer

2009



ALESSANDRO MALFATTI

A turning point in leadership: Alessandro Malfatti becomes General Manager

2010



ASA DENTAL USA

International presence consolidated with the opening of Asa Dental's US subsidiary

2012



ASAONE

Investments to boost production efficiency for disposable products to enhance quality, quantity and competitiveness

2013



ASA DENTAL CHINA

Asa Dental China becomes operational, supporting one of the fastest growing markets

2014



MANIAGO

The Maniago plant improves productivity and the quality of stainless steel instruments

2015



BOZZANO

The Smart warehouse in Italy powers logistics to minimize delivery time

2016



EDUCATIONAL CENTER

The new Educational Center connects leaders, universities, and dental professionals

2018



DUBAI

Asa Dental consolidates its presence in the Middle East with a new subsidiary in Dubai

2019



DIGITAL INTEGRATION

Digital technologies connect product design, development and communication

2023



SUSTAINABILITY

New photovoltaic plant at the Logistics Center in Bozzano.

A GLOBAL PRESENCE

Making people smile, anywhere in the world, means being close to dental professionals, developing a deep understanding of the underlying differences of each market, and tailoring products and solutions to the exact needs of qualified professionals.

Through a structured international presence, with subsidiaries in the USA, China and the UAE, Asa Dental can operate at maximum efficiency at a global level, yet meet market requests at local level. The headquarters in Italy coordinates production, sales and logistics, managing an offer of innovative and traditional solutions powered by creative design and quality manufacturing - the contemporary interpretation of the Made-in-Italy spirit.

We proudly serve qualified dentists in more than 170 countries, helping them improve the quality of life of millions of patients and staying true to our mission by making effective dentistry accessible to everyone. Everywhere.



A. ITALY



B. USA



C. CHINA



D. UAE

INNOVATION MEETS TRADITION

Production has become Asa Dental's second nature from the very beginning.

Bucking a worldwide trend of decentralized production, we have decided to concentrate the entire manufacturing in Italy and guarantee our customers the unmatched quality they deserve. The strict control over the whole production process of disposable products and stainless steel instruments translates into a constant improvement in product quality and operational efficiency.

Each production plant focuses on its core competences, allowing employees to enhance their expertise and the processes to be optimized. Regardless of the product, we can consistently respond to constantly shifting markets, whether in terms of quantity, quality or application.

With hundreds of thousands of products delivered every year, uncompromising quality testing and absolute traceability of products guarantee qualified dentists that every single product they use delivers all the necessary effectiveness, safety and comfort their patients demand.

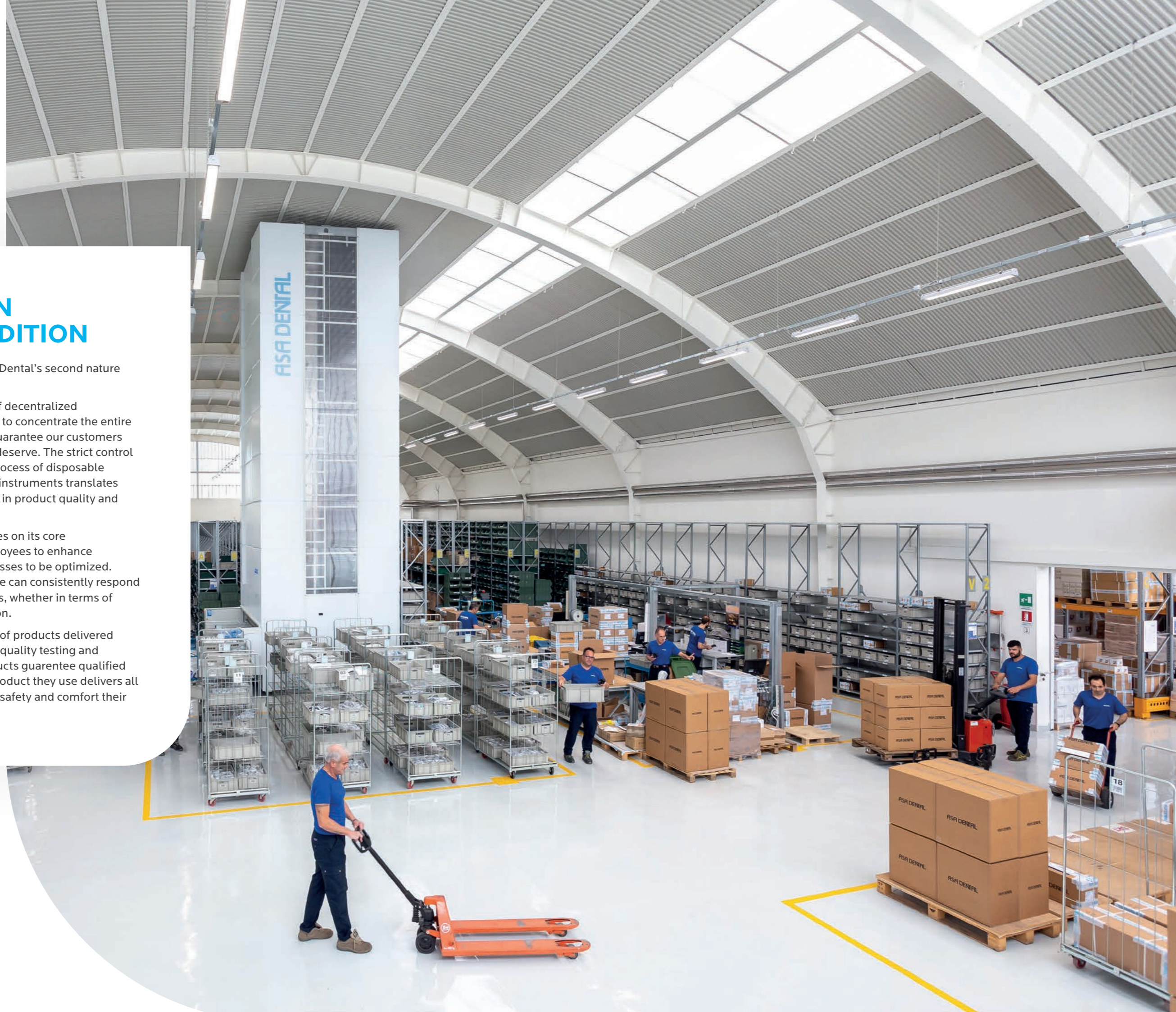

ADVANCED DIGITAL INTEGRATION

We have revolutionized the digital integration of our services. All the items in the catalogue are available both on the website and on the mobile app, where you can consult 3D models and detailed technical specs. Thanks to an advanced management system, ordering

and preparation are streamlined, integrating perfectly with the vertical warehouse. This ensures faster and more precise shipping, guaranteeing our customers an optimal shopping experience, reducing wait times and improving overall satisfaction.



OUR COMMITMENT

At Asa Dental, sustainability is at the heart of our activities. We are firmly committed to producing a positive impact on the environment and on the communities we serve. Through innovative practices and responsible choices, we try to minimize our ecological impact, preserve natural resources and promote social wellbeing.

Our relentless dedication to sustainability spurs us to constantly improve our processes, products and services, thus ensuring a brighter and more sustainable future for the next generations. Together, we are shaping a world where sustainability is not just a goal, but an intrinsic element of our identity and of our operations.



**2023
2024**

New photovoltaic plant at our Logistics Center

Introduction of ZeroWaste packaging with Smart Label



**2025
2026**

Minimizing glue and hot fixing

Minimizing multi-material packaging



**2027
2028**

Carbon Free

Application of new strategies to reuse packaging



**2029
2030**

Elimination of multi-material packaging

Introduction of biodegradable packaging

SCIENTIFIC NAME INDEX

SCIENTIFIC NAME	INSTRUMENT TYPE	PAGE
Adson	Needle holders	C10
Adson	Tissue pliers	C38, E36
Adson-Brown	Tissue pliers	C41
Ainsworth	Dental dam instruments	F11
Allen	Periosteals and Elevators	E23, H16
Apexo	Root elevators with a stainless steel ergonomic handle	D62
Apexo	Root elevators with a stainless steel handle	D56
Arruga	Needle holders	C15
Asa	Modeling instruments	L14
Backhaus	Towel clamps	C31
Ball	Filling instruments	F34
Barnhart	Curettes and Scalers	H5
Baumgartner	Needle holders	C11
Beale	Modeling instruments	L16
Beale	Periosteals and Elevators	E22, H16
Bein	Root elevators with a stainless steel ergonomic handle	D61
Bein	Root elevators with a stainless steel handle	D49,D50
Beyer	Bone rongeurs	D44
Black/26	Cavity preparation instruments	F21
Black/27	Cavity preparation instruments	F21
Black/28	Cavity preparation instruments	F21
Black/29	Cavity preparation instruments	F21
Black/51-52	Cavity preparation instruments	F22
Black/53-54	Cavity preparation instruments	F22
Black/77-78	Cavity preparation instruments	F21
Black/79-80	Cavity preparation instruments	F21
Blumenthal	Bone rongeurs	D43, E30
Boehm	Crown instruments	F45, L29
Boley	Crown instruments	F44, L30
Bowman	Lacrimal probes	C37
Brewer	Dental dam instruments	F12
Bruenings	Retractors	C34
Buchwald	Retractors	C34
Buck	Gingivectomy knives	H24, H25
Buckley	Bone chisels and gouges	H27
Buser	Membrane placement instrument	E31
Buser	Periosteals and Elevators	E22, H16
Castroviejo	Needle holders	C18, E6
Cattoni	Double-ended explorers	B8
Chompret	Syndesmotomes with a stainless steel handle	D67
Cleveland	Bone rongeurs	D42
Cleveland-Gardner	Bone rongeurs	D42
Cogswell	Root elevators with a stainless steel handle	D56
Coleman	Root elevators with a stainless steel handle	D48
Collin	Tongue holding forceps	C33

SCIENTIFIC NAME	INSTRUMENT TYPE	PAGE
Columbia	Curettes and Scalers	H4
Columbia	Retractors	C34
Cooley	Tissue pliers	C38
Coupland	Root elevators with a stainless steel handle	D58
Coupland	Root elevators with a stainless steel handle	D60
Crane-Kaplan	Gingivectomy knives	H25
Crane-Kaplan (Goldman-Fox)	Curettes and Scalers	H8
Crane-Kaplan (Goldman-Fox)	Periodontal pocket markers	B3, E35, H31
Crite	Hemostats	C20
Crite-Wood	Needle holders	C10, C11
Cryer	Extracting forceps - American pattern	D28
Cryer	Extracting forceps - American pattern - AsaLady	D32
Cryer	Root elevators with a stainless steel ergonomic handle	D62
Cryer	Root elevators with a stainless steel handle	D57
Curtis	Root elevators with a stainless steel handle	D55
Darby-Perry	Excavators	F20
De Marco	Curettes and Scalers	H5
Dean	Gum scissors	C7
Derf	Needle holders	C13
Didner	Matrix retainers	F48
Eiselberg-Mathieu	Needle holders	C15
Fahnenstock	Wax knives	L22
Farabeuf	Retractors	C35
Flagg	Cotton and dressing pliers	B4, B5
Flohr	Root elevators with a stainless steel ergonomic handle	D61
Flohr	Root elevators with a stainless steel handle	D51, D60
Foc	Amalgam filling instruments, Composite instruments	F33, F51
Frahm	Modeling instruments, Composite instruments	F39, L13
Frazier	Surgical stainless steel saliva ejectors	C44
Freer	Freer single cut chisels	E16
Freer	Periosteals and Elevators	E24, H17
Friedman	Bone rongeurs	D42
Friedman	Root elevators with a stainless steel handle	D59
Furrer	Crown instruments	F45
Gardner	Bone chisels and gouges	H27
Gillies	Needle holders	C14
Goldman-Fox	Bone/soft tissue nipper, Periodontal instruments	D44, E29, H30
Goldman-Fox	Curettes and Scalers	H6
Goldman-Fox	Expros (combination explorers/probes)	B10
Goldman-Fox	Gingivectomy knives	H25
Goldman-Fox	Gum scissors	C3, C4, E4
Goldman-Fox	Periodontal pocket Probes	H3
Goldman-Fox	Periosteals and Elevators	E22, H16
Goldman-Fox	Root canal Explorers	B10
Goldman-Fox-Williams	Expros (combination explorers/probes)	B11
Gracey	Gracey curettes	G17, H11
Gracey	Gracey curettes - AF	H12
Gracey	Gracey curettes - MF	H13
Greenstein	Ceramic sculpting instruments	L21
Gritman	Modeling instruments	L16
Gritman	Plaster knives	L23
Gross-Maier	Dressing forceps	C32

SCIENTIFIC NAME	INSTRUMENT TYPE	PAGE
Halsey	Needle holders	C13
Halsey-Smooth	Needle holders	C13
Halstead-Mosquito	Hemostats	C21, F46, G19
Halstead-Mosquito	Orthodontic instruments	I36
Harris	Extracting forceps - American pattern	D26
Harris	Extracting forceps - American pattern - AsaLady	D30
Hartmann	Hemostats	C23
Hegar-Baumgartner	Needle holders	C11
Heidbrink	Root elevators with a stainless steel ergonomic handle	D62
Heidbrink	Root elevators with a stainless steel handle	D56
Heidbrink	Root-tip picks with stainless steel handle	D65, D66
Hemingway	Bone curettes	C45, E21, H20
Herbert	Surgical mallets	H29
Hirschfeld	Files	H22
Hollenback	Amalgam filling instruments	F31
Hollenback	Composite instruments	F51
Hollenback	Modeling instruments	F38, L13
Hopkins	Periosteals and Elevators	E24, H17
Hourigan	Periosteals and Elevators	E23, H16
Howard	Bone files	H23
Hull	Extracting forceps - American pattern	D27
Hull	Extracting forceps - American pattern - AsaLady	D31
Hygienist	Scalers	H15
Hylin	Modeling instruments	L14
Hylin	Root elevators with a stainless steel handle	D45
Hylin-Le Cron	Modeling instruments	L14
Indiana University	Curettes and Scalers	H5
Iris	Gum scissors	C4, C5
Ivory	Dental dam instruments	F11, F12
Ivory	Matrix retainers	F48
Ivory	Vision® Shade	F4
Iwanson	Crown instruments	F44, L30
Jacquette	Curettes and Scalers	H9
Jacquette	Scalers	H15
Jameson	Crown instruments	L30
Jones	Towel clamps	C31
Kelly	Gum scissors	C5, E4
Kelly	Hemostats	C23, F46
Kilner	Retractors	C35
Kirkland	Gingivectomy knives	H24
Kocher	Hemostats	C20
Kocher	Retractors	C36
Konig	Periosteals and Elevators	E25, H18
Kopp	Root elevators with a stainless steel handle	D52
Ladmore	Filling instruments	F34
LaGrange	Gum scissors	C7
Langenbeck	Retractors	C36
Langer	Curettes and Scalers	H5
Le Cron	Modeling instruments	L15
Lecluse	Root elevators with a stainless steel ergonomic handle	D65
Lessman	Wax knives	L22
Lichtenberg	Needle holders	C15, E5

SCIENTIFIC NAME	INSTRUMENT TYPE	PAGE
Locklin	Gum scissors	C6
London College	Cotton and dressing pliers	B4, B5
London Hospital	Root elevators with a stainless steel handle	D48
Lucas	Bone curettes	H20
Luer	Bone rongeurs	D42, E30
Luks	Root canal Pluggers	B13, G5
Luniatschek	Operative instruments, Orthodontic instruments	F41, I36
Machtou	Root canal Pluggers	B13, G5
MacMillan	Root elevators with a stainless steel handle	D58
Markley	Amalgam filling instruments	F32
Marquette	Amalgam filling instruments	F31
Mathieu	Needle holders	C16, C17, E5
Mayo	Gum scissors	C8
Mayo-Hegar	Needle holders	C12
McCall	Curettes and Scalers	H7
Mead	Bone rongeurs	D43
Mead	Periosteals and Elevators	E24, H17
Mead	Surgical mallets	E16, H29
Meriam	Cotton and dressing pliers	B4, B5
Meriam	Laboratory tweezers	L19
Merrit	Periodontal pocket Probes	H3
Mershon	Orthodontic instruments	I34
Metzenbaum	Gum scissors	C8
Metzenbaum-Delikat	Gum scissors	C8, E4
Micro-Adson	Tissue pliers	C38, C39, G18
Micro-Mosquito	Hemostats	C22, F46
Middeldorp	Retractors	C37, E12
Miller	Bone files	E21, H23
Miller	Crown instruments	F44
Miller-Apexo	Root elevators with a stainless steel ergonomic handle	D62
Miller-Apexo	Root elevators with a stainless steel handle	D54
Mini Crane-Kaplan	Curettes and Scalers	H8
Mini Friedman	Bone rongeurs, Periodontal instruments	D42, E30, H30
Mini Friedman	Root elevators with a stainless steel handle	D59
Mini-Ruskin	Bone rongeurs	D44
Mini-Ryder	Needle holders	C13
Minnesota University	Retractors	C34, E12
Molt	Mouth gags	C33
Molt	Periosteals and Elevators	E23, H16
Nabers	Double-ended explorers	B11
Neumann	Gum scissors	C7
Nevius	Extracting forceps - American pattern	D27
Nevius	Extracting forceps - American pattern - AsaLady	D31
Novatech	Periodontal pocket Probes	H3
Noyes	Gum scissors	C7
Ochsenbein	Bone chisels and gouges	H27
Ochsenbein	Surgical chisels	H26
Ogden-Felsch	Extracting forceps	D19
Olsen-Hegar	Needle holders	C10
Orban	Gingivectomy knives	H24
Orban	Operative instruments	F41
Orringer	Retractors	C34, E11

SCIENTIFIC NAME	INSTRUMENT TYPE	PAGE
P. K. Thomas	Composite instruments	F50, F52
P. K. Thomas	Modeling instruments	L17
Partsch	Bone chisels and gouges	H28
Partsch	Periosteals and Elevators	E24, H17
Partsch	Surgical mallets	E16, H29
Pean	Hemostats	C20
Perry	Cotton and dressing pliers	B4
Physick	Extracting forceps - American pattern	D25
Physick	Extracting forceps - American pattern - AsaLady	D29
Polokoff	Bone files	H23
Pott	Root elevators with a stainless steel ergonomic handle	D65
Prichard	Periosteals and Elevators	E23, H16
Quinby	Gum scissors	C5
Rhodes	Surgical chisels	H26
Roach	Modeling instruments	L16
Roser-Koenig	Mouth gags	C33
Roturier	Extracting forceps	D6, D7, D16
Rule	Curettes and Scalers	H5
Sanders	Gingivectomy knives	H25
Schaedle	Towel clamps	C31
Schilder	Root canal Pluggers	B14, G6
Schluger	Files	H22
Schmeckebier-Apexo	Root elevators with a stainless steel ergonomic handle	D61
Schmeckebier-Apexo	Root elevators with a stainless steel handle	D51
Seldin	Periosteals and Elevators	E25, G16, H18
Seldin	Root elevators with a stainless steel ergonomic handle	D62
Seldin	Root elevators with a stainless steel handle	D54, D55, D56
Semken-Taylor	Tissue pliers	C41, E36
Senn-Miller	Retractors	C35
Spencer	Gum scissors	C8
SS. White	Excavators	F19
Sternberg	Retractors	C34, E11
Stevens	Gum scissors	C9
Stieglitz	Root and splinter forceps, Endodontic instruments	D41, G3
Stoke	Dental dam instruments	F12
Stout	Root elevators with a stainless steel handle	D55
Sugarman	Files	H22
Sullivan	Gum scissors	C6
Tanner	Amalgam filling instruments	F31
Taylor	Curettes and Scalers	H8
TG Chisel	Surgical chisels	H26
Toennis	Needle holders	C14
Tofflemire	Matrices	F49
Tofflemire	Matrix retainers	F48
Tomati	Periodontal instruments	H30
Tomes	Extracting forceps - American pattern	D27
Tomes	Extracting forceps - American pattern - AsaLady	D31
Towner	Scalers	H14
Towner-Jacquette	Scalers	H14
Townley	Crown instruments	L30
Trotter	Extracting forceps	D17, D19, D20
U.S.A. model	Bone curettes	H21

SCIENTIFIC NAME	INSTRUMENT TYPE	PAGE
Universal Scaler	Scalers	H14
University of Michigan	Expros (combination explorers/probes)	B10
University of Michigan	Periodontal pocket Probes	H3
USC Towner	Gingivectomy knives	H25
Vehe	Modeling instruments	L16
Vickers	Surgical mallets	H29
W.F. Barry	Root elevators with a stainless steel ergonomic handle	D63
Wahl	Bone files	H23
Wakefield	Bone chisels and gouges	H27
Ward	Amalgam filling instruments	F31
Ward	Modeling instruments	F38, L13
Warwick-James	Root-tip picks with stainless steel handle	D66
Wedelstaet	Cavity preparation instruments	F22
Westcott	Amalgam filling instruments	F28
Westcott	Filling instruments	F34
Westcott	Gum scissors	C7, G19
White	Extracting forceps	D17
Wiland	Modeling instruments	F39
Williams	Expros (combination explorers/probes)	B10
Williams	Periodontal pocket Probes	H3
Williger	Bone curettes	H21
Williger	Periosteals and Elevators	E25, H19
Williger	Retractors	C35
Winter	Root elevators with a stainless steel ergonomic handle	D64
Witzel	Extracting forceps for roots	D40
Woodson	Plastic filling instruments	F37
Woodward	Root elevators with a stainless steel handle	D58
Younger-Good	Curettes and Scalers	H8
Zahle	Modeling instruments	L15, L16
Zerfing-Chisel	Curettes and Scalers	H4

ASAONE

MADE IN ITALY



NUMBER ONE IN QUALITY DISPOSABLE PRODUCTS

Asa Dental has tapped into its design and manufacturing experience - the same experience which made its saliva ejectors #1 in the world - and applied it to an entire product category. The result is AsaOne, a line of disposable products designed for the safety and comfort of dental professionals and their patients.

Safe materials and innovative design meet color and shape, to turn every dental practice into a welcoming place where the best possible results are achieved.

- A2 Saliva ejectors
- A6 Napkins
- A8 Dappen dishes
- A10 Plastic trays
- A11 Cotton rolls
- A12 Sterilization rolls
- A13 Surgical masks
- A14 Sterilization pouches
- A15 Bibs
- A16 Accessories

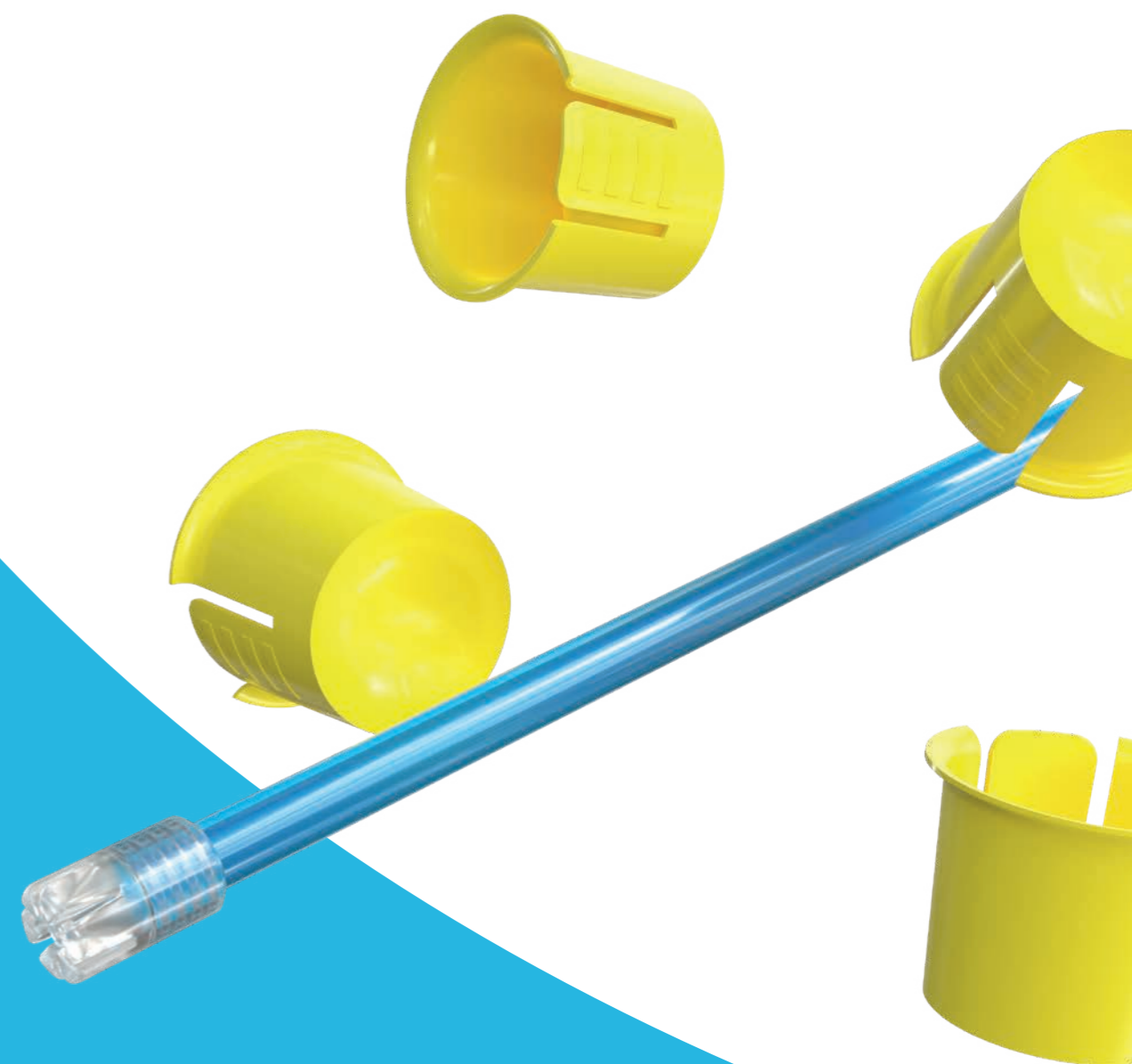

MINT-SCENTED SALIVA EJECTORS - ASAFRESH



Removable tip
100 pcs / bag
10 bags / carton
1000 pcs

2908E-AT13/15
blue tube
transparent tip

2908E-TT13/T15
transparent tube
transparent tip

2908E-VT13/15
green tube
transparent tip



150 mm
2908E-AT15
130 mm
2908E-AT13



150 mm
2908E-TT15
130 mm
2908E-TT13



150 mm
2908E-VT15
130 mm
2908E-VT13

Bonded tip
100 pcs / bag
10 bags / carton
1000 pcs

2908E-BBS15
white tube
white tip

2908E-TCS15
transparent tube
light-blue tip

2908E-TTS15
transparent tube
transparent tip

2908E-VTS15
green tube
transparent tip



150 mm
2908E-BBS15



150 mm
2908E-TCS15



150 mm
2908E-TTS15



150 mm
2908E-VTS15

SOFT-TIP SALIVA EJECTORS - TOTAL-COMFORT



Removable tip
100 pcs / bag
10 bags / carton
1000 pcs

2903E-BA155
white tube
blue tip

2903E-BT155
white tube
transparent tip

2903E-TA155
transparent tube
blue tip

2903E-TT155
transparent tube
transparent tip



155 mm
2903E-BA155



155 mm
2903E-BT155



155 mm
2903E-TA155



155 mm
2903E-TT155

Bonded tip
100 pcs / bag
10 bags / carton
1000 pcs

2903E-BAS155
white tube
blue tip

2903E-BTS155
white tube
transparent tip

2903E-TAS155
transparent tube
blue tip

2903E-TTS155
transparent tube
transparent tip



155 mm
2903E-BAS155



155 mm
2903E-BTS155



155 mm
2903E-TAS155



155 mm
2903E-TTS155

MULTI-COLOR SALIVA EJECTORS



2900E

Removable tip
100 pcs / bag
10 bags / carton
1000 pcs

2900E-AT13/15
blue tube
transparent tip

2900E-TT13/15
transparent tube
transparent tip

2900E-VT13/15
green tube
transparent tip

2900E-BT13/15
white tube
transparent tip

2900E-GT13/15
yellow tube
transparent tip

2900E-LT13/15
lilac tube
transparent tip



150 mm
2900E-AT15
2901E-AT15
130 mm
2900E-AT13
2901E-AT13



150 mm
2900E-TT15
2901E-TT15
130 mm
2900E-TT13
2901E-TT13



150 mm
2900E-VT15
2901E-VT15
130 mm
2900E-VT13
2901E-VT13

2901E

Removable tip
250 pcs / bag
20 bags / carton
5000 pcs

2901E-AT13/15
blue tube
transparent tip

2901E-TT13/T15
transparent tube
transparent tip

2901E-VT13/15
green tube
transparent tip



150 mm
2900E-BT15
130 mm
2900E-BT13



150 mm
2900E-GT15
130 mm
2900E-GT13



150 mm
2900E-LT15
130 mm
2900E-LT13

MULTI-COLOR SALIVA EJECTORS



Removable tip
100 pcs / bag
10 bags / carton
1000 pcs

2900E-OT13/15
orange tube
transparent tip

2900E-RT13/15
red tube
transparent tip

2900E-ZT13/15
cyan tube
transparent tip



150 mm
2900E-OT15
130 mm
2900E-OT13



150 mm
2900E-RT15
130 mm
2900E-RT13

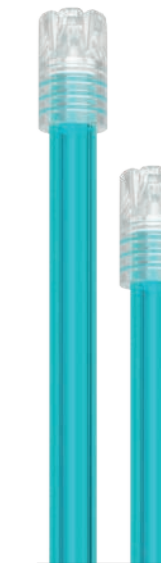

150 mm
2900E-ZT15
130 mm
2900E-ZT13

Bonded tip
100 pcs / bag
10 bags / carton
1000 pcs

2900E-ATS15
blue tube
transparent tip

2900E-BBS15
white tube
white tip

2900E-TCS15
transparent tube
light-blue tip

2900E-TTS15
transparent tube
transparent tip

2900E-VTS15
green tube
transparent tip



150 mm
2900E-ATS15



150 mm
2900E-BBS15



150 mm
2900E-TCS15



150 mm
2900E-TTS15



150 mm
2900E-VTS15

NAPKINS - ASARAINBOW

33x45 cm 2-ply

3509
carton of 500 pcs

33x45 cm 3-ply

3510
carton of 500 pcs

3511
available on request
50 pcs / bag
10 bags / carton
500 pcs
Minimum 80 cartons per color
(1 pallet)

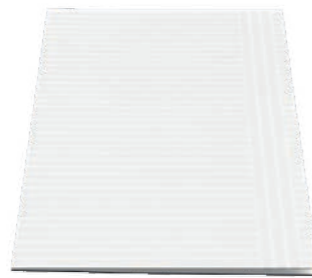

White

3509-B	normal
3510-B	normal
3510.B	Medical Device
3511-B	normal
3511.B	Medical Device

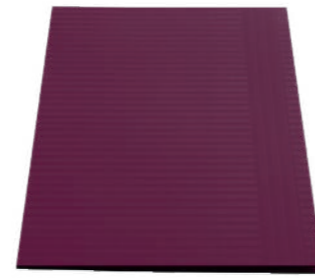

Burgundy

3510-BX	normal
3510.BX	Medical Device
3511-BX	normal
3511.BX	Medical Device

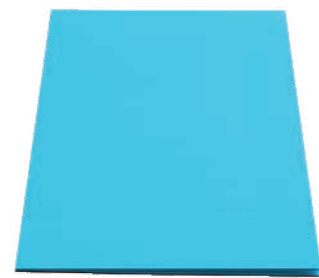

Light blue

3509-C	normal
3510-C	normal
3510.C	Medical Device
3511-C	normal
3511.C	Medical Device

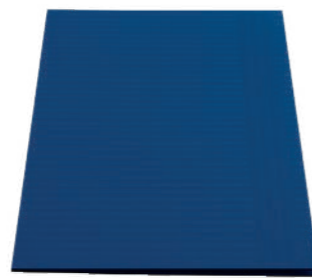

Dark blue

3509-D	normal
3510-D	normal
3510.D	Medical Device
3511-D	normal
3511.D	Medical Device



Fuchsia

3510-F	normal
3510.F	Medical Device
3511-F	normal
3511.F	Medical Device



Yellow

3510-G	normal
3510.G	Medical Device
3511-G	normal
3511.G	Medical Device

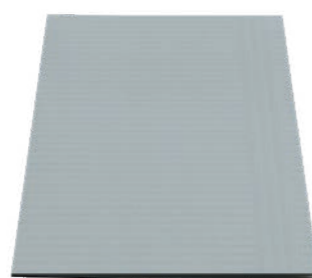

Grey

3510-GR	normal
3510.GR	Medical Device
3511-GR	normal
3511.GR	Medical Device

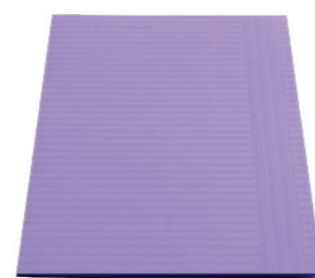

Lilac

3509-L	normal
3510-L	normal
3510.L	Medical Device
3511-L	normal
3511.L	Medical Device

NAPKINS - ASARAINBOW



Lime

3510-LI	normal
3510.LI	Medical Device
3511-LI	normal
3511.LI	Medical Device

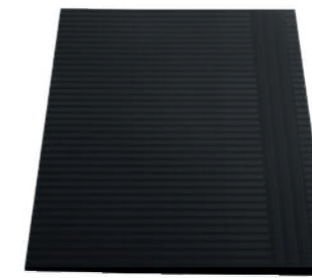

Black

3509-N	normal
3510-N	normal
3510.N	Medical Device
3511-N	normal
3511.N	Medical Device



Orange

3510-O	normal
3510.O	Medical Device
3511-O	normal
3511.O	Medical Device

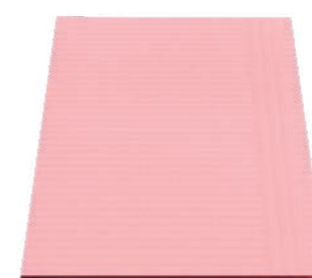

Pink

3509-P	normal
3510-P	normal
3510.P	Medical Device
3511-P	normal
3511.P	Medical Device



Peach

3510-PE	normal
3510.PE	Medical Device
3511-PE	normal
3511.PE	Medical Device



Green

3509-V	normal
3510-V	normal
3510.V	Medical Device
3511-V	normal
3511.V	Medical Device

Patient bib chain



3201



DAPPEN DISHES

50 pcs / bag
 5 bags per color / carton
 1000 pcs



Yellow + Red + White + Blue
 3700-MX



DAPPEN DISHES

50 pcs / bag
 20 packs / carton
 1000 pcs



Black
 3700-N



Yellow
 3700-G



Blue
 3700-C



White
 3700-B



Red
 3700-R

PLASTIC TRAYS

281x183x17 mm

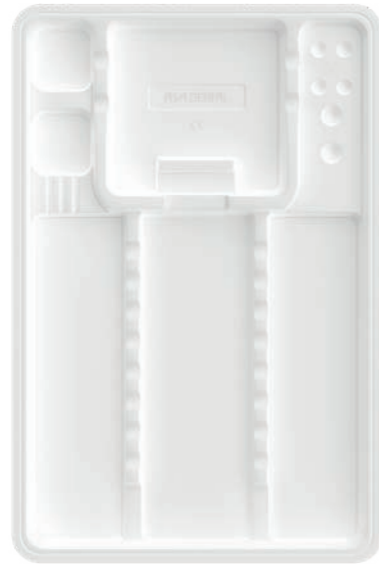

White smooth
AL2727-1

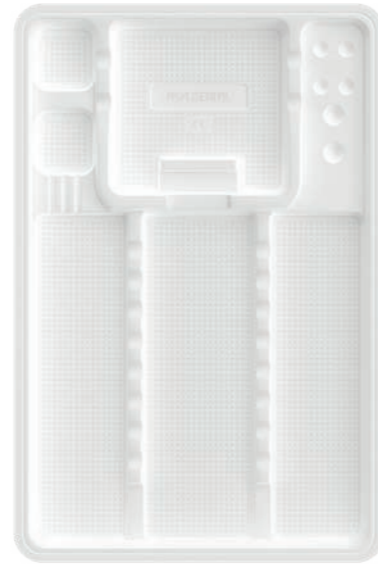

White knurled
AL2727-1Z

183x140x17 mm



White smooth
AL2727-2



White knurled
AL2727-2Z

200x150 mm
400 pcs / pack



White smooth
AL2738-1

200x100 mm
400 pcs / pack



White smooth
AL2738-2

COTTON ROLLS

Bagged
100% cotton
300 gr. / bag
20 bags / carton

Ø 8 mm | 840 pcs
3520-1



100% cotton
300 gr. / bag
20 bags / carton

Ø 10 mm | 600 pcs
3520-2



100% cotton
300 gr. / bag
20 bags / carton

Ø 12 mm | 450 pcs
3520-3



STERILIZATION ROLLS

Heavyweight paper and one ply of polypropylene film with sterilization process indicator.

8 pcs / carton

50 mm x 200 m
3400E-55

75 mm x 200 m
3400E-75

4 pcs / carton

100 mm x 200 m
3400E-100

150 mm x 200 m
3400E-150

2 pcs / carton

200 mm x 200 m
3400E-200

250 mm x 200 m
3400E-250

1 pc / carton

300 mm x 200 m
3400-300



SURGICAL MASKS

Earloop face masks

High-quality materials
nonwoven fabric
hypoallergenic
fiberglass-free
B.F.E. level: 99.7%

50 pcs / box
6 boxes / carton
300 pcs



White
3450E-B



Light blue
3450E-C

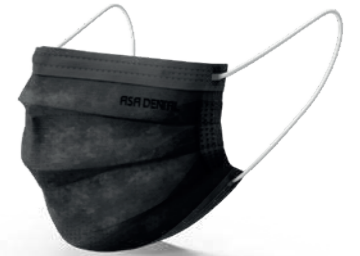

Black
3450E-N



Pink
3450E-R



Green
3450E-V

STERILIZATION POUCHES

Self-sealing pouches

200 pcs / box
12 boxes / carton
2400 pcs



75x250 mm
3403-75



90x230 mm
3403-90

200 pcs / box
8 boxes / carton
1600 pcs



140x250 mm
3403-140

BIBS

Tear-off rolls

waterproof
two-ply
(polyethylene and paper)

3251E
50x60 cm
80 sheets
6 rolls / carton

3252E
50x80 cm
60 sheets
6 rolls / carton



Light blue
3251E-C/6
3252E-C/6



Dark blue
3251E-D/6
3252E-D/6



Orange
3251E-O/6
3252E-O/6



Green
3251E-V/6
3252E-V/6

CUPS

200 cc
100 pcs / pack
30 packs / carton
3000 pcs



White
3818-B

DRINKING CUP DISPENSERS

85 x 85 x 360 mm
for max 70 cups



Silver
2750-1



White
2750-2

MIXING SPATULAS

100 pcs / pack



AL2736

USED NEEDLE HOLDER

plastic container



AL2766

MIXING TRAYS

70x54x6 mm
12 wells
1000 pcs / pack



AL2735

PLASTIC SYRINGES

for elastomers
50 pcs / box
10 boxes / carton
500 pcs



3710

WASTE CONTAINER

1000 pcs / pack



AL2767-1

Aluminum base for waste containers



AL2767-2

INSTANT ICE COLD PACK

14x18 cm
nonwoven fabric bag
temperature -4°C
25 bags / carton



3600E

DISPOSABLE PLASTIC IMPRESSION TRAYS

24 pcs / pack



12 lower + 12 upper (by size)



1
2853E-1

2
2853E-2

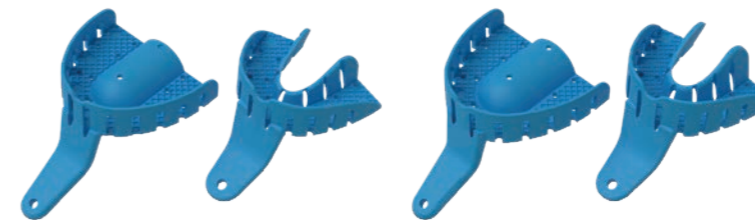

3
2853E-3

4
2853E-4

12 partial right + 12 partial left (by size)



1
2853E-1DS

2
2853E-2DS

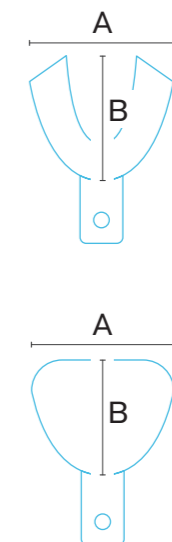

Lower	A (mm)	B (mm)
1	61	50
2	67	52
3	72	56
4	74	58

Upper	A (mm)	B (mm)
1	61	49
2	65	53
3	70	59
4	73	63

DIAGNOSTICS

MADE IN ITALY



B3	Periodontal pocket markers
B3	Cotton and dressing pliers
B6	Explorers
B10	Expros (combination explorers/probes)
B12	Root canal spreaders
B13	Pluggers
B15	Vertical condensers
B15	Excavators
B17	Mirrors
B21	Ultralight retractors
B22	Kits

OUR RANGE OF INSTRUMENTS FOR A COMPLETE AND EFFICIENT DIAGNOSIS

"The ultimate goal of dental care is to facilitate the lifelong maintenance of every patient's oral health. It all starts with a reliable diagnosis that is clearly and effectively communicated to the patient.

For this reason, we have designed diagnostic instruments in materials and shapes that offer the ideal trade-off between precision, elasticity, ergonomics and durability, with different emphasis depending on the scope of the instrument."



HANDLE

SINGLE-ENDED

Asa60
(stainless steel)
ø 6.0 mm

Asa60M
(stainless steel, solid)
ø 6.0 mm

Leonardo ML
(stainless steel)
ø 7.0 mm

● **Alu80**
(aluminum, hollow)
ø 8.0 mm

● **AsaWave RC**
(plastic resin in PPSU
with a steel core)
ø 7.5 / 14.5 mm



DOUBLE-ENDED

Asa60
(stainless steel)
ø 6.0 mm

Asa Light MV
(stainless steel, hollow)
ø 8.0 mm

Leonardo ML
(stainless steel)
ø 7.0 mm

● **AsaWave RC**
(plastic resin in PPSU
with a steel core)
ø 7.5 / 14.5 mm

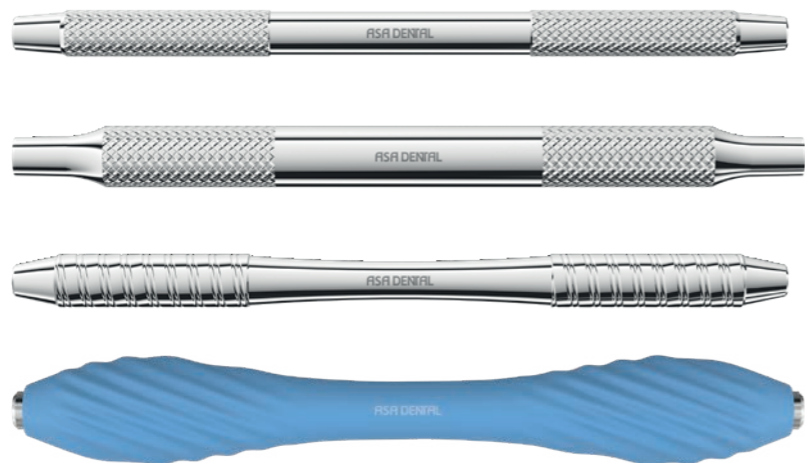

HOW TO USE THE INFORMATION

- 3R Rhein** → model + scientific name
- 0700-3R** → Asa Dental code
- Asa60 → handle option

AsaLady

products ergonomically designed for women's hands:

- smaller and lighter handles
- smaller finger holes
- reduced size

code starts with "W" or "SW"

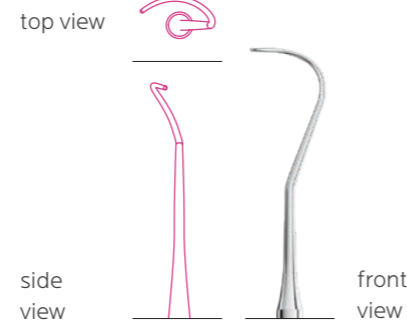
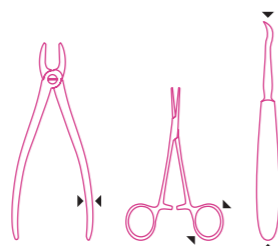

PERIODONTAL POCKET MARKERS



1 (Crane-Kaplan) Goldman-Fox
15 cm
0650-1

2 (Crane-Kaplan) Goldman-Fox
15 cm
0650-2

COTTON AND DRESSING PLIERS

self-locking

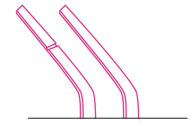

18L
16 cm
0600-18L

1
15 cm
0602-1

2
15 cm
0602-2

COTTON AND DRESSING PLIERS

Set of 5



COTTON AND DRESSING PLIERS



0600-2

Antimagnetic and easy to clean, these pliers are light enough to ensure comfort and durable enough to ensure long-term effectiveness.

Their different shapes and angles make them ideal for any situation. The tip has a coating which will not stick to filling materials, making it a versatile instrument for positioning them inside the cavity.



SINGLE-ENDED EXPLORERS



3
0700-3
Asa60
0701-3
Asa60M



3A
0700-3A
Asa60
0701-3A
Asa60M



3R Rhein
0700-3R
Asa60
ML0700-3R
Leonardo ML



5
0700-5
Asa60
0701-5
Asa60M



6
0700-6
Asa60
0701-6
Asa60M
ML0700-6
Leonardo ML
RC0700-6
● AsaWave RC



8
0700-8
Asa60
0701-8
Asa60M
ML0700-8
Leonardo ML



9
0700-9
Asa60
0701-9
Asa60M
ML0700-9
Leonardo ML
RC0700-9
● AsaWave RC



10
0700-10
Asa60
0701-10
Asa60M



11
0700-11
Asa60
0701-11
Asa60M



12
0700-12
Asa60
0701-12
Asa60M



2
0700-2
Asa60
0701-2
Asa60M

16
0700-16
Asa60
0701-16
Asa60M



17
0700-17
Asa60
0701-17
Asa60M
ML0700-17
Leonardo ML



17A
0700-17A
Asa60
0701-17A
Asa60M



23
0700-23
Asa60
0701-23
Asa60M
ML0700-23
Leonardo ML
RC0700-23
● AsaWave RC

SINGLE-ENDED EXPLORERS



0700-23

Sharp and pointed explorers, perfect to detect even the smallest cavity. They offer the perfect balance between elasticity and rigidity.

Thanks to the thin tip and controlled flexibility, they are extremely useful to detecting fissures and oversize fillings, as well as confirming of optimal occlusion in fixed dental prosthetics.

Set of 5
Asa60

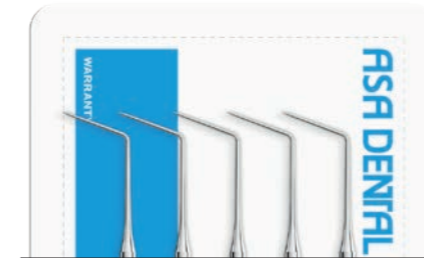

6
S0700-6

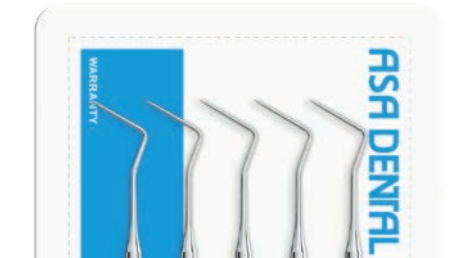

9
S0700-9



11
S0700-11

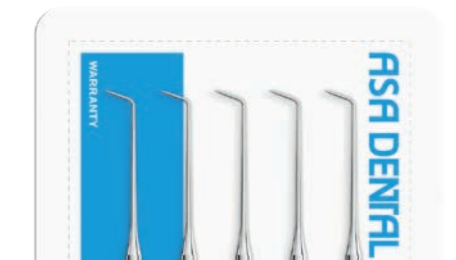

16
S0700-16

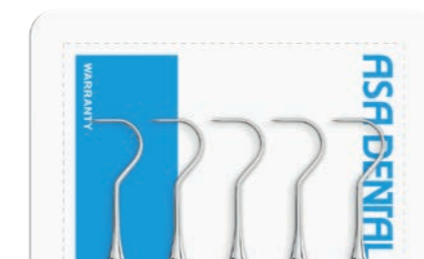

23
S0700-23

DOUBLE-ENDED EXPLORERS



6/9
ML0704-6D9
 Leonardo ML
0704-6D9
 Asa60

 11/12AF 0704-11/12AF Asa60 ML0704-11/12AF Leonardo ML	 16/23 0704-16D1 Asa60 MV0704-16D1 Asa Light MV	 16/3 0704-16D2 Asa60 MV0704-16D2 Asa Light MV	 23/17 0704-23D1 Asa60 MV0704-23D1 Asa Light MV ML0704-23D1 Leonardo ML RC0704-23D1 ● AsaWave RC
 23/17A 0704-23D2 Asa60 MV0704-23D2 Asa Light MV	 UT 1/2 Cattoni 0704-UT1 Asa60 MV0704-UT1 Asa Light MV	 2 0709-2 Asa60 MV0709-2 Asa Light MV	 2A 0709-2A Asa60 MV0709-2A Asa Light MV

DOUBLE-ENDED EXPLORERS

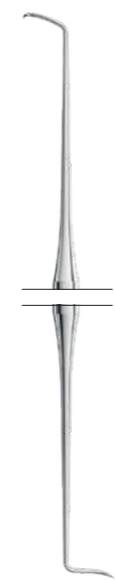

3
0709-3
 Asa60
MV0709-3
 Asa Light MV

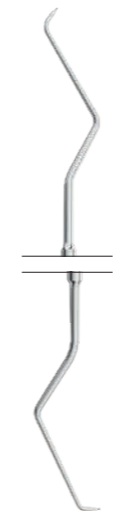

17/19
ML0704-6D2
 Leonardo ML

ROOT CANAL EXPLORERS



6/1
MV0710-6D1
 Asa Light MV
0710-6D1
 Asa60

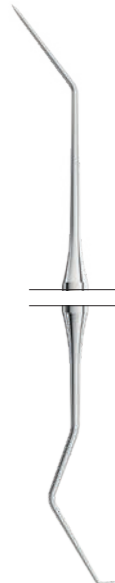

6/17
0710-6D2
 Asa60
MV0710-6D2
 Asa Light MV

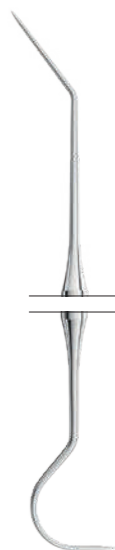



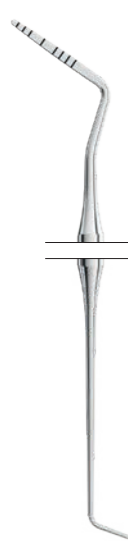
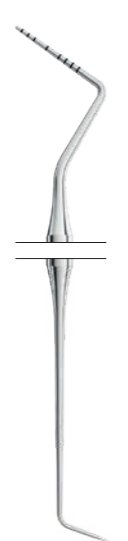
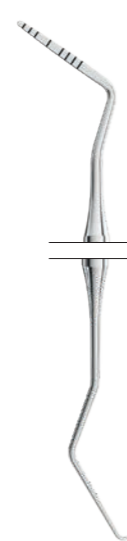
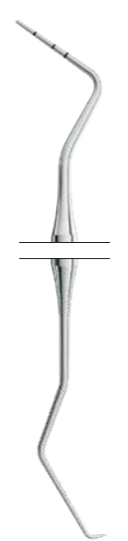
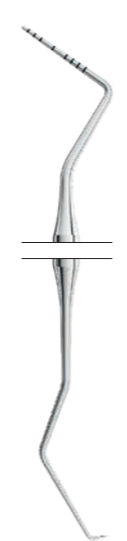
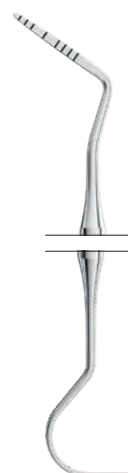
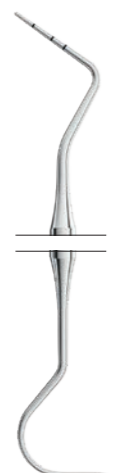
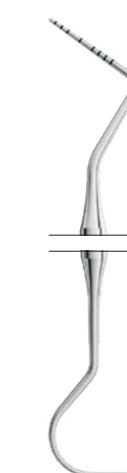
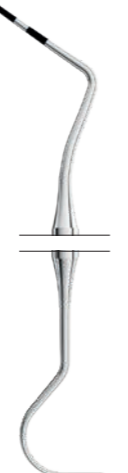
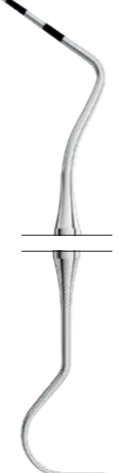

6/23
0710-6D3
 Asa60
MV0710-6D3
 Asa Light MV

EXPROS (COMBINATION EXPLORERS/PROBES)

1 2 3 5 7 8 9 10 FLAT TIP	1 2 3 5 7 8 9 10 FLAT TIP	1 2 3 5 7 8 9 10	1 2 3 5 7 8 9 10 FLAT TIP	3 6 8	1 2 3 5 7 8 9 10
					
3 Goldman-Fox 0705L-3GF Asa60 MV0705-3GF Asa Light MV	16 Goldman-Fox 0705L-16GF Asa60 MV0705-16GF Asa Light MV	16 Williams 0705L-16W Asa60 MV0705-16W Asa Light MV	17 Goldman-Fox 0705L-17GF Asa60 MV0705-17GF Asa Light MV	17 University of Michigan 0705L-17UM Asa60 MV0705-17UM Asa Light MV	17 Williams 0705L-17W Asa60 MV0705-17W Asa Light MV
	1 2 3 5 7 8 9 10 FLAT TIP	3 6 8	1 2 3 5 7 8 9 10	3 6 8 11	3 6 9 12
					
	23 Goldman-Fox 0705L-23GF Asa60 MV0705-23GF Asa Light MV	23 University of Michigan 0705L-23UM Asa60 MV0705-23UM Asa Light MV	23 Williams 0705L-23W Asa60 MV0705-23W Asa Light MV ML0705-23W Leonardo ML	23/CP11 0706L-2311 Asa60 MV0706-2311 Asa Light MV	23/CP12 0706L-2312 Asa60 MV0706-2312 Asa Light MV

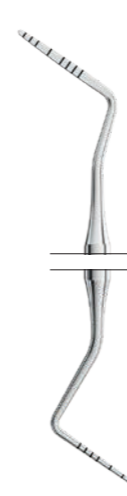
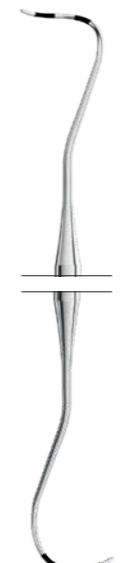
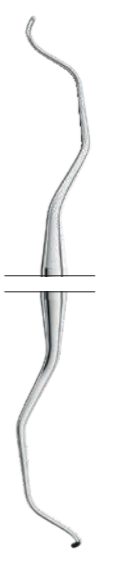
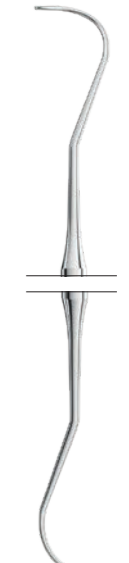
DOUBLE-ENDED EXPLORERS

1 2 3 5 7 8 9 10 12 14	1 2 3 5 7 8 9 10 FLAT TIP	3 6 9 12		
				
Goldman-Fox Williams RC0707-GFW ● AsaWave RC	1 2 3 5 7 8 9 10 Goldman-Fox Williams 0707L-GFW Asa60 MV0707-GFW Asa Light MV	12 9 6 3 2N Nabers 0708L-2N Asa60	1N Nabers 0708-1N Asa60 MV0708-1N Asa Light MV	2N Nabers 0708-2N Asa60 MV0708-2N Asa Light MV ML0708-2N Leonardo ML
1 2 3 5 7 8 9 10 12 14				
				
1 2 3 5 7 8 9 10 12 14 Goldman-Fox Williams RC0707-GFW ● AsaWave RC				



MV0707L-GFW

ROOT CANAL SPREADERS

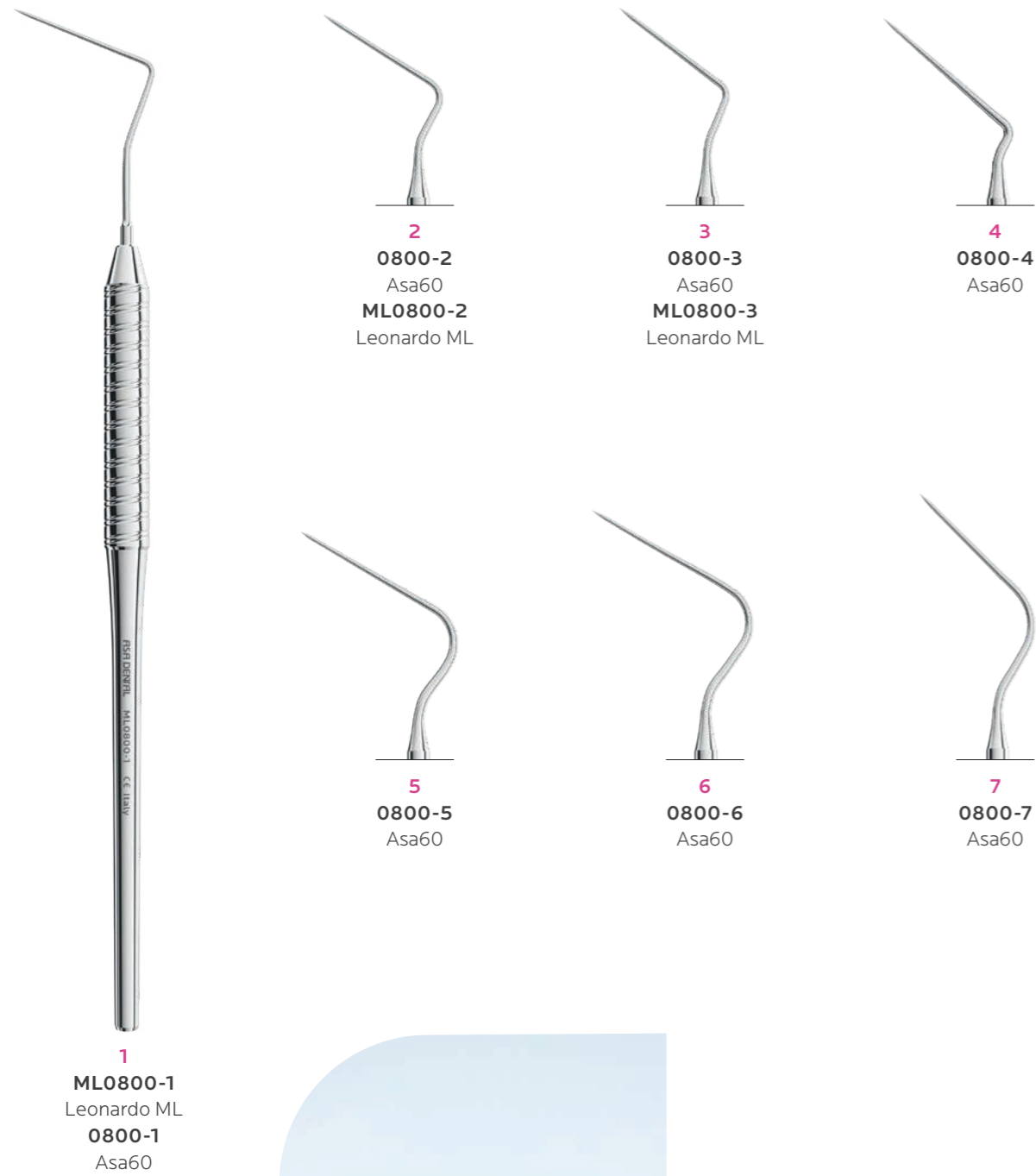

0800-1

Root canal instruments

A special coating helps tips work without adhering, in all conditions, including those that require extra pressure.

ROOT CANAL PLUGGERS



ROOT CANAL PLUGGERS



7 ½ Schilder
ML0802-1
Leonardo ML



8 Schilder
ML0802-2
Leonardo ML



8 ½ Schilder
ML0802-3
Leonardo ML



9 Schilder
ML0802-4
Leonardo ML



9 ½ Schilder
ML0802-5
Leonardo ML



10 Schilder
ML0802-6
Leonardo ML



10 ½ Schilder
ML0802-7
Leonardo ML



10 Schilder
ML0802-10
Leonardo ML



11 Schilder
ML0802-8
Leonardo ML



11 ½ Schilder
ML0802-9
Leonardo ML

VERTICAL CONDENSERS



1
0802L-1
Asa60



2
0802L-2
Asa60



3
0802L-3
Asa60



4
0802L-4
Asa60

ROOT CANAL EXCAVATORS



31L
1709-31L
Asa60
MV1709-31L
Asa Light MV



32L
1709-32L
Asa60
MV1709-32L
Asa Light MV



33L
1709-33L
Asa60
MV1709-33L
Asa Light MV

ENDODONTIC RULER

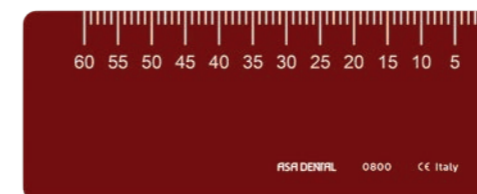

0800

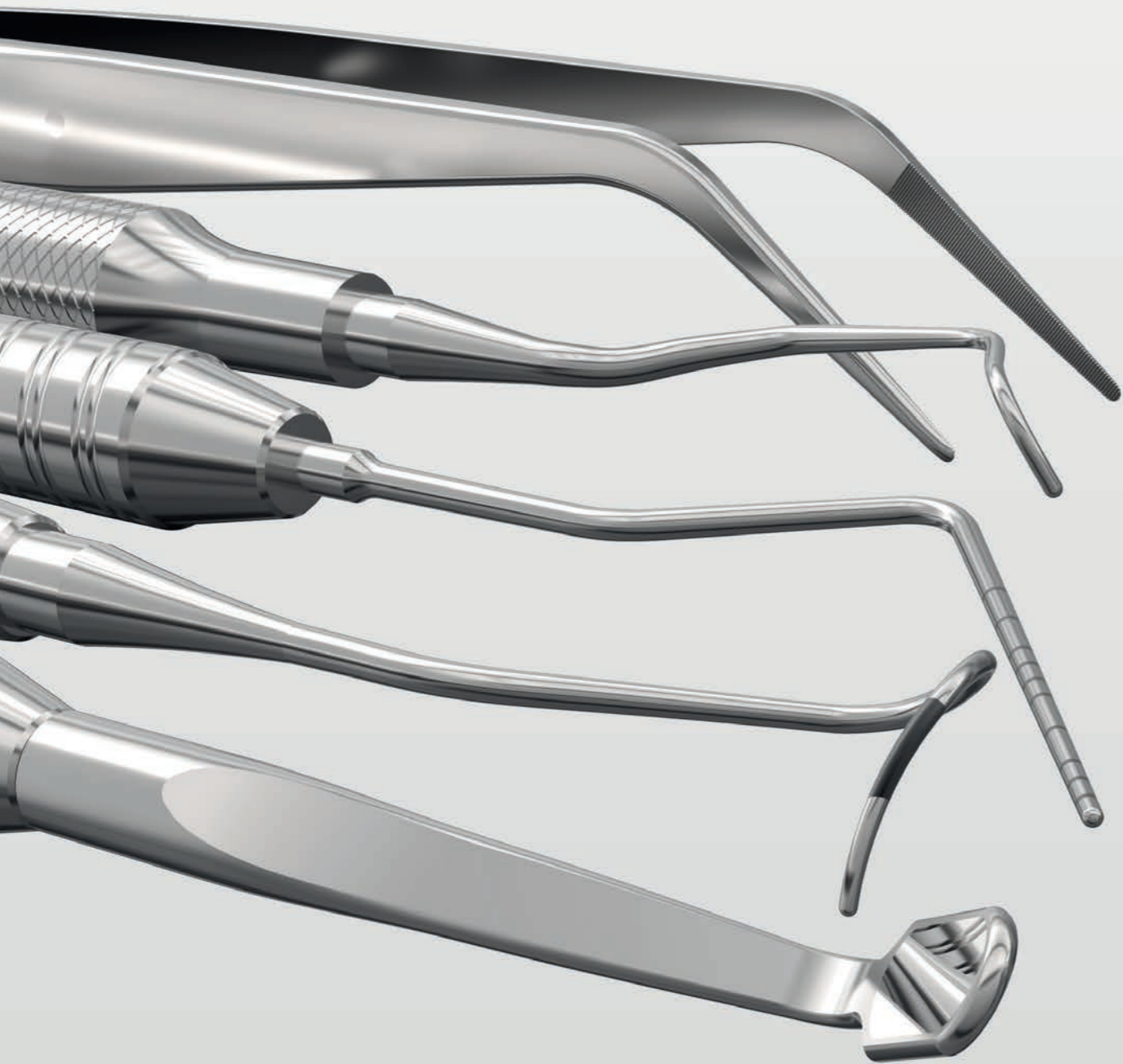

GLASS PHOTO MIRRORS

Occlusal surfaces



Buccal surfaces



Lingual surfaces



SIMPLE STEM MOUTH MIRRORS

Box of 12



Box of 12



Box of 12



Box of 6



SIMPLE STEM MOUTH MIRRORS

Single



SIMPLE STEM MOUTH MIRROR HANDLES

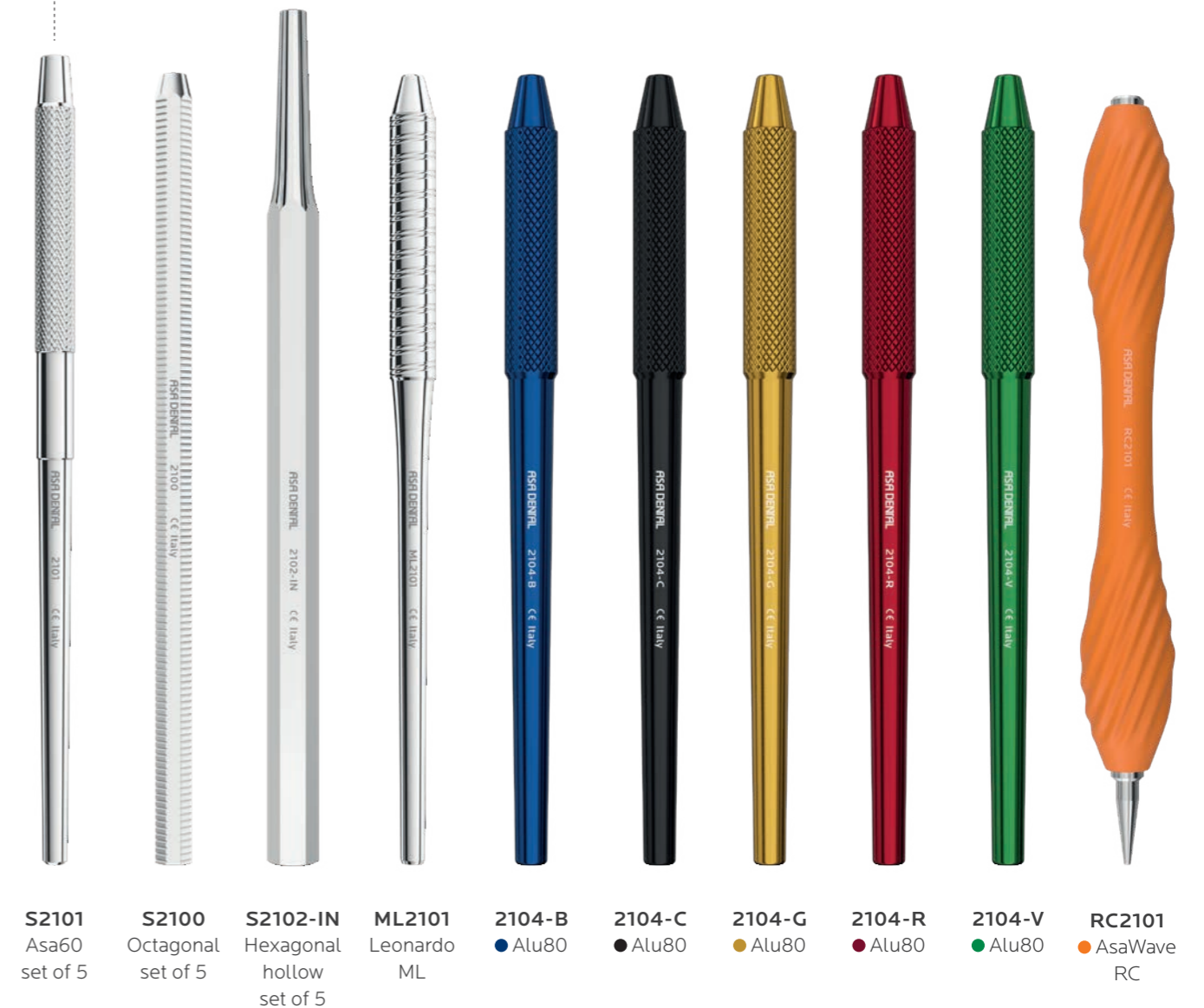

MOUTH MIRRORS - AMERICAN PATTERN

Cone socket

Box of 12



Box of 6



HANDLES
Cone socket



2100-CS
Octagonal



2101-CS
Asa60



2102-CS
Hexagonal

ULTRALIGHT MIRROR

Technical data:

Philips miniature light bulbs
shatterproof 2.25 V - 0.25 A
2 x 1.5 V alkaline batteries AAA type

spare parts:

- 0690-G O-ring
- 0690-L lamp
- 0690-M spring
- 0690-T head with mandrel

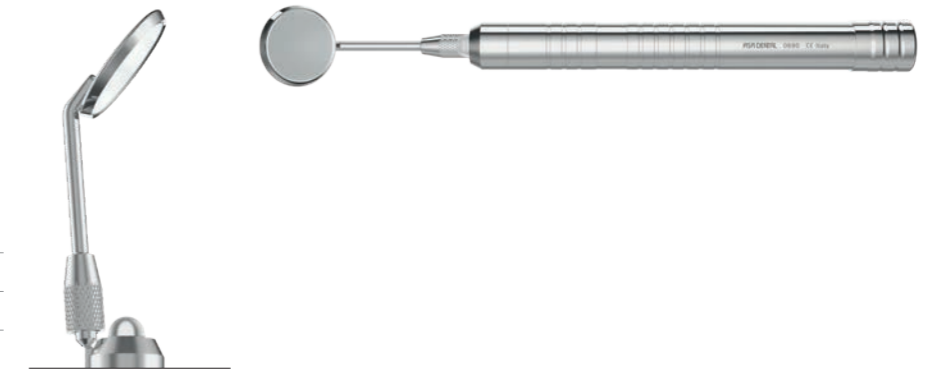

17 cm
0690

ULTRALIGHT RETRACTORS

Technical data:

Philips shockproof miniature
lamps 2.25 V - 0.25 A
2 x 1.5 V alkaline batteries AAA type



14 cm
0691

KIT - ULTRALIGHT

with a mirror and retractor in a mini locking tray:

- 0690 ultralight mirror
- 0691 ultralight retractor
- 2772-1 mini locking tray

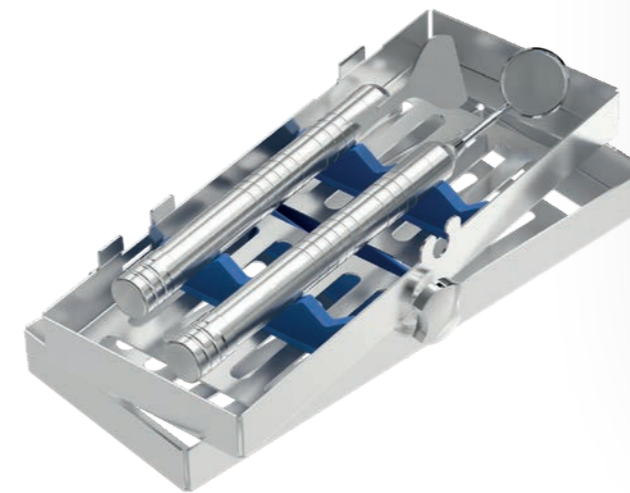

S0690-2

How to use the Ultralight Mirror and the Ultralight Retractor:

- insert 2 alkaline batteries
- remove the batteries prior to sterilization
- sterilizable O-ring on the light to stop saliva or liquid from getting into the handle, thus preserving battery life
- easy on/off through the bottom cap that works as a switch
- no maintenance required for electrical or mechanical parts
- full disassembly for proper cleaning
- easy battery and light bulb replacement
- ergonomic handle

INSTRUMENT KIT FOR FIRST EXAMINATIONS



S0600-6

0700-6	anatomic handle explorer	6
0601-2	London-College cotton and dressing pliers	2
2101	anatomic mouth mirror handle	
2200-4	plane mouth mirror	4



S0600-9

0700-9	anatomic handle explorer	9
0601-2	London-College cotton and dressing pliers	2
2101	anatomic mouth mirror handle	
2200-4	plane mouth mirror	4



S0600-23

0700-23	anatomic handle explorer	23
0601-2	London-College cotton and dressing pliers	2
2101	anatomic mouth mirror handle	
2200-4	plane mouth mirror	4

INSTRUMENT KIT FOR FIRST EXAMINATIONS - ASALADY



SWML0600-6

WML0700-6	anatomic handle explorer	6
W0610-2	London-College cotton and dressing pliers	2
WML2101	Leonardo mouth mirror handle	
2200-4	plane mouth mirror	4



SWML0600-9

WML0700-9	anatomic handle explorer	9
W0610-2	London-College cotton and dressing pliers	2
WML2101	Leonardo mouth mirror handle	
2200-4	plane mouth mirror	4



SWML0600-23

WML0700-23	anatomic handle explorer	23
W0610-2	London-College cotton and dressing pliers	2
WML2101	Leonardo mouth mirror handle	
2200-4	plane mouth mirror	4

INSTRUMENT KIT FOR FIRST EXAMINATIONS - ASAWAVE



SRC0600-6

RC0700-6	explorer with a AsaWave handle	6
0601-2	London-College cotton and dressing pliers	2
RC2101	handle for a AsaWave mouth mirror	
2200-4	plane mouth mirror	4



SRC0600-9

RC0700-9	explorer with a AsaWave handle	9
0601-2	London-College cotton and dressing pliers	2
RC2101	handle for a AsaWave mouth mirror	
2200-4	plane mouth mirror	4



SRC0600-23

RC0700-23	explorer with a AsaWave handle	23
0601-2	London-College cotton and dressing pliers	2
RC2101	handle for a AsaWave mouth mirror	
2200-4	plane mouth mirror	4



KIT FOR ENDODONTICS



Set 6 instruments
S0800

AL2746-1	aluminum endodontic instrument cleaner	
0800	endodontic ruler	
0601-2	London-College cotton and dressing pliers	
2101	anatomic mouth mirror handle	
2200-4	plane mouth mirror	4
0710-6D1	root canal explorer	6/1
1709-31L	root canal excavator	31L
0800-1	spreader	1
S2702	perforated instrument tray complete with insert frame	



Set of 7 instruments
(Laser engraving)
S0702L-7

0702L-12S	O.M.S. periodontal pocket probe with a colored tip (laser engraved)	CP-12S
0702L-12	periodontal pocket probe with a colored tip (laser engraved)	CP-12
0703L-1	Williams pocket probe (laser engraved)	
0703L-4	Goldman-Fox pocket probe (laser engraved)	
0706L-2312	combined explorer/pocket probe (laser engraved)	23/CP-12
0802L-1	vertical condenser (laser engraved)	1
0802L-2	vertical condenser (laser engraved)	2
0800	endodontic ruler	
S2702	perforated instrument tray complete with insert frame	

KIT FOR ENDODONTICS

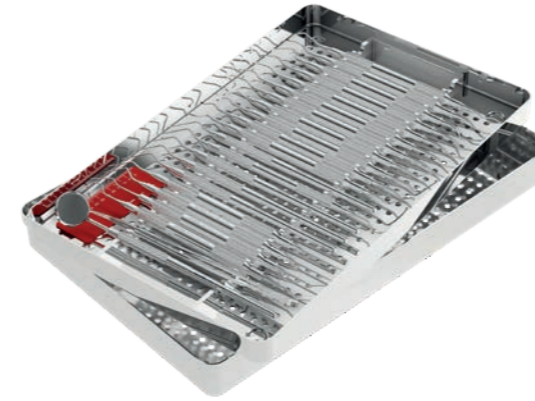

set of 23
Boston University instruments
S0702L-23

0601-2	London-College cotton and dressing pliers	2
2101	anatomic mouth mirror handle	
2200-4	plane mouth mirror	4
0800	endodontic ruler	
MV0704-23D1	Asa Light double-ended explorer	23/17
MV0710-6D1	Asa Light root canal explorer	6/1
MV0705-16W	Asa Light Williams expro (explorer/probe)	16
MV0705-3GF	Asa Light Goldman-Fox expro (explorer/probe)	3
0702L-12S	O.M.S. periodontal pocket probe with a colored tip (laser engraved)	CP-12S
0702L-12	periodontal pocket probe with a colored tip (laser engraved)	CP-12
0702L-11	periodontal pocket probe with a colored tip (laser engraved)	CP-11
0706L-2312	combined explorer/pocket probe (laser engraved)	23/CP-12
0800-1	spreader	1
MV1709-32L	Asa Light root canal excavator	32L
MV1706-19	Asa Light double-ended excavator	19
MV1703-14	Asa Light double-ended excavator	14
MV1701-1	Asa Light double-ended excavator	1
MV1807-02	Asa Light Gracey curette	1/2
MV1807-04	Asa Light Gracey curette	3/4
MV1807-06	Asa Light Gracey curette	5/6
MV1807-08	Asa Light Gracey curette	7/8
MV1807-10	Asa Light Gracey curette	9/10
MV1807-12	Asa Light Gracey curette	11/12
MV1807-14	Asa Light Gracey curette	13/14
S2722-2	perforated instrument tray complete with insert frame	2

ORAL SURGERY

MADE IN ITALY



SURGICAL PRECISION: NECESSARY AND INDISPENSABLE

As a dental professional, you know that the more invasive a procedure is, the clearer your communication with your patient must be. Your patient's safety, your reassurance and the management of the clinical case become as important as the procedure itself. Through the combination of your skills in the field and our precision instruments, you can ensure an optimal outcome in the shortest amount of time. That is precisely why we answer the call of professionals like you who seek ergonomic instruments that help reduce the complexity of the procedure and prevent complications.

- C3 Scissors
- C10 Needle holders
- C20 Hemostats
- C24 Scalpels
- C28 Dental syringes
- C31 Towel clamps
- C32 Dressing forceps
- C33 Mouth gags
- C33 Tongue holding forceps
- C34 Retractors
- C37 Lacrimal probes
- C38 Tissue pliers
- C44 Saliva ejectors
- C45 Bone curettes
- C46 Kits



HANDLE

DOUBLE-ENDED

Asa60

(stainless steel)
ø 6.0 mm



Asa Light MV

(stainless steel, hollow)
ø 8.0 mm



Leonardo ML

(stainless steel)
ø 7.0 mm



standard instrument



instrument with tungsten carbide (TC) inserts

HOW TO USE THE INFORMATION

- 1 Hemingway → model + scientific name
- ML2000-1 → Asa Dental code
- Leonardo ML → handle option

AsaLady

products ergonomically designed for women's hands:

- smaller and lighter handles
- smaller finger holes
- reduced size

code starts with "W" or "SW"

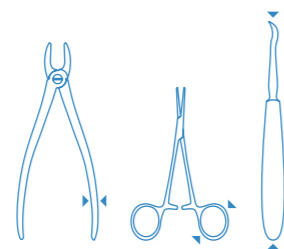

these products are not manufactured by Asa Dental and are distributed with the manufacturer's brand



top view



side view

GUM SCISSORS



1 straight
12 cm
0300-1

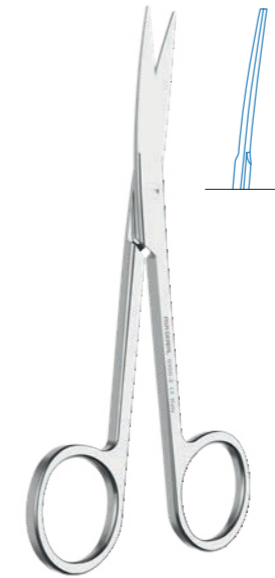

2 curved
12 cm
0300-2



1 straight
12 cm
W0319-1



2 curved
12 cm
W0319-2



1 angular
11.5 cm
0301-1



1 angular
one serrated blade
11.5 cm
0301-2



1 Goldman-Fox
straight
one serrated blade
13 cm
0304-1

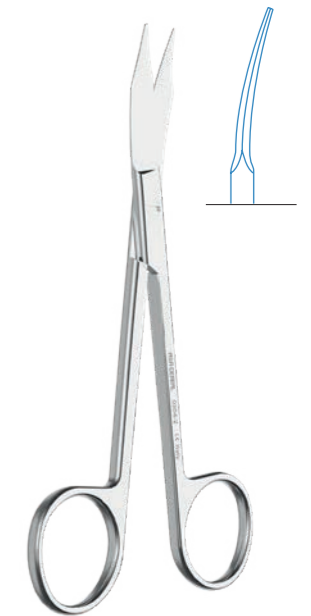

2 Goldman-Fox
curved
one serrated blade
13 cm
0304-2

GUM SCISSORS



1 Iris
straight
11.5 cm
0305-1



2 Iris
curved
11.5 cm
0305-2



1TC Iris
straight
11.5 cm
0305-1TC



2TC Iris
curved
11.5 cm
0305-2TC



3 Iris
curved
11.5 cm
0305-3



1 Quinby
straight
13 cm
0308-1



2 Quinby
curved
13 cm
0308-2



3 Goldman-Fox (special)
curved
one serrated blade
13 cm
0304-3



1TC Goldman-Fox
straight
13 cm
0304-1TC



2TC Goldman-Fox
curved
13 cm
0304-2TC

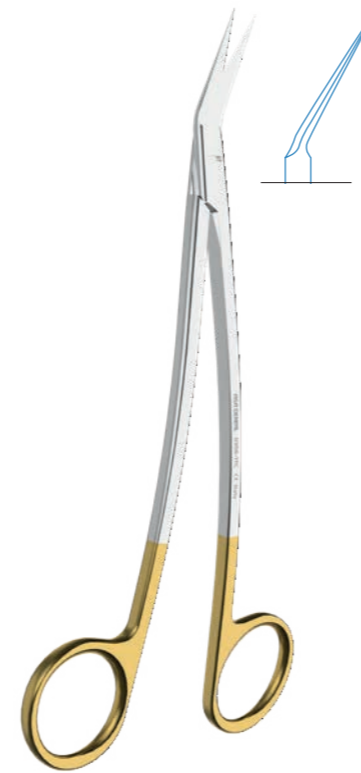

1TC Goldman-Fox
curved
17 cm
0306-1TC

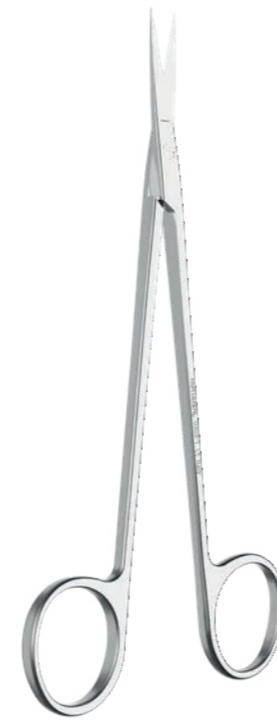

1 Kelly
straight
16 cm
0309-1



2 Kelly
curved
16 cm
0309-2



1TC Kelly
straight
16 cm
0309-1TC



2TC Kelly
curved
16 cm
0309-2TC

GUM SCISSORS



1 Sullivan
straight
one serrated blade
14.5 cm
0311-1



2 Sullivan
curved
one serrated blade
14.5 cm
0311-2

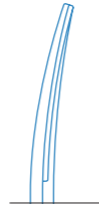

1TC Locklin
angular
16.5 cm
0310-1TC

GUM SCISSORS



1 Neumann
curved
12.5 cm
0302-1

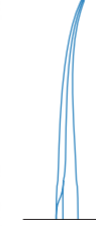

1 Dean
curved
one serrated blade
17 cm
0306-1

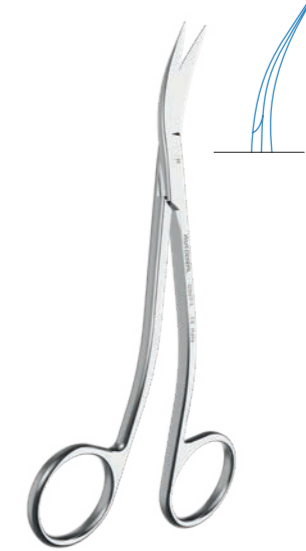

1 La Grange
curved
one serrated blade
12 cm
0307-1



1 Locklin
angular
one serrated blade
16.5 cm
0310-1



2 Locklin
angular
one serrated blade
16.5 cm
0310-2



2TC Locklin
angular
16.5 cm
0310-2TC

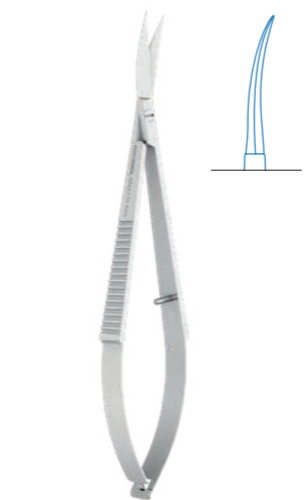

1 Noyes (Castroviejo)
curved
very thin beaks
12 cm
0303-1

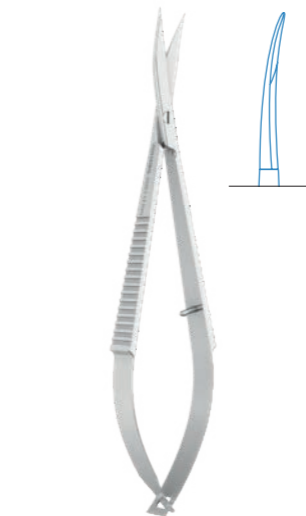

1 Westcott
curved
sharp beaks
11 cm
0312-1

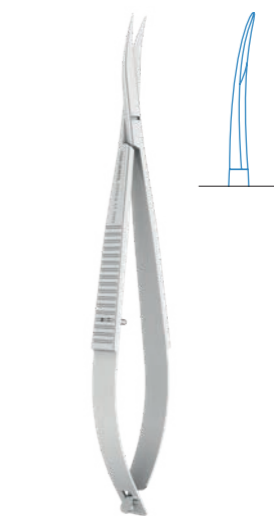

2 Westcott
curved
blunt beaks
11 cm
0312-2

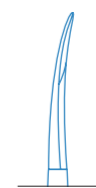

1
curved
very thin beaks
14.5 cm
0313-1



GUM SCISSORS

suture scissors

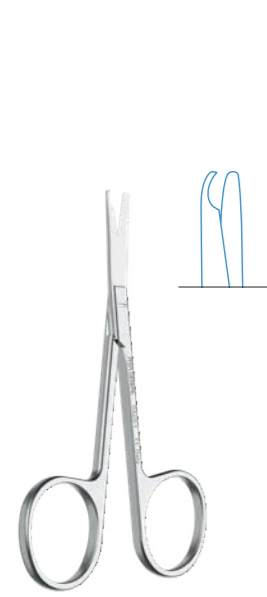

1 Spencer
9 cm
0320-1



2 Spencer
13 cm
0320-2



1 Mayo
straight
14.5 cm
0325-1

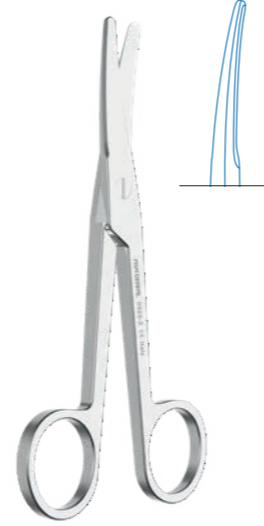

2 Mayo
curved
14.5 cm
0325-2



Stevens
straight
11.5 cm
0330-1



Stevens
curved
11.5 cm
0330-2

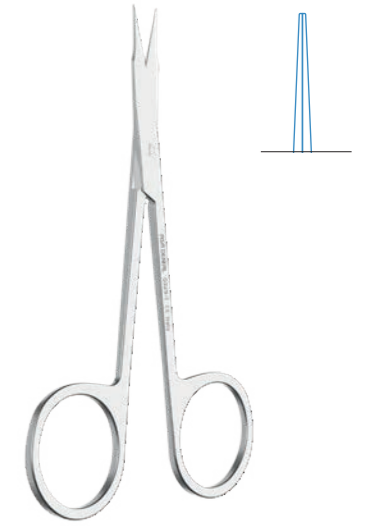

Stevens
rounded straight beaks
11.5 cm
0329-1

dissecting scissors



1 Metzenbaum
straight
14.5 cm
0321-1



2 Metzenbaum
curved
14.5 cm
0321-2



1 Metzenbaum-Delikat
straight
14.5 cm
0322-1



2 Metzenbaum-Delikat
curved
14.5 cm
0322-2



Stevens
straight
11.5 cm
0328-1



Stevens
curved
11.5 cm
0328-2

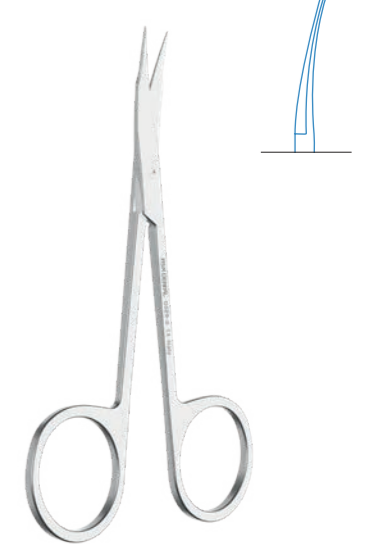

Stevens
rounded curved beaks
11.5 cm
0329-2

NEEDLE HOLDERS



Olsen-Hegar
scissors combined
14 cm
0400-14



TC Olsen-Hegar
14 cm
0405-14TC



Crile-Wood
15 cm
0410-15



TC Crile-Wood
15 cm
0415-15TC

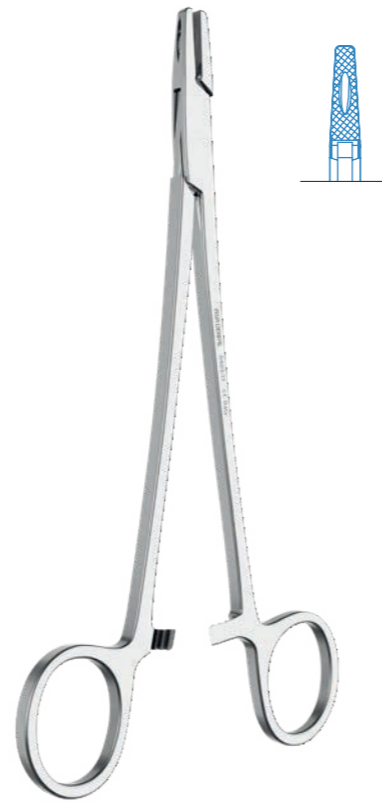

Adson
17.5 cm
0403-17



Baumgartner
14.5 cm
0404-14



TC Hegar-Baumgartner
14 cm
0409-14TC



Crile-Wood
15 cm
W0411-15

NEEDLE HOLDERS



TC Crile-Wood
15 cm
W0411-15TC

0409-14TC



AsaLady

AsaLady

NEEDLE HOLDERS



Mayo-Hegar
16 cm
0420-16



TC Mayo-Hegar
16 cm
0425-16TC



Mayo-Hegar
16 cm
W0412-16



Mayo-Hegar
18 cm
0420-18



TC Mayo-Hegar
18 cm
0425-18TC



TC Mayo-Hegar
16 cm
W0412-16TC

NEEDLE HOLDERS



Derf
12 cm
0401-12

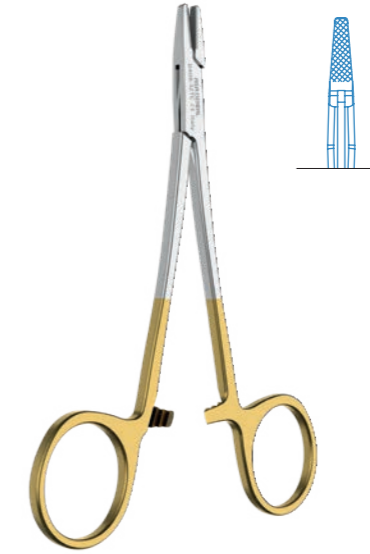

TC Derf
12 cm
0406-12TC

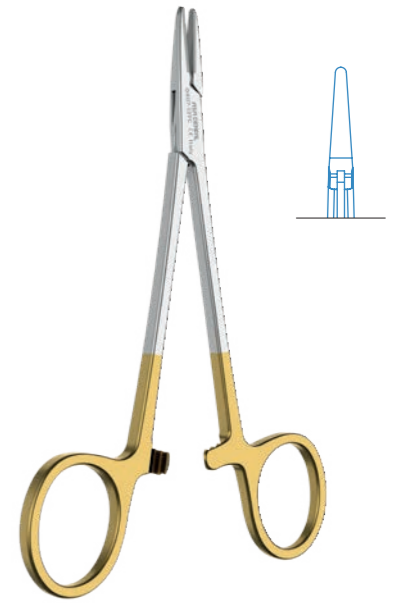

TC Halsey-Smooth
smooth jaws
13 cm
0407-13TC

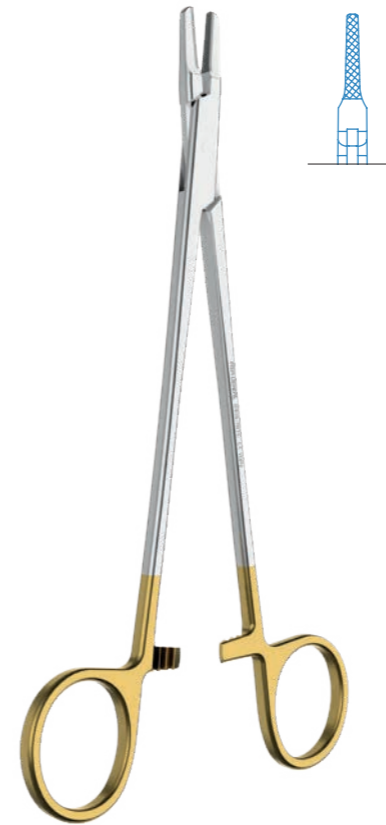

TC Mini-Ryder
18 cm
0416-18TC



TC Mini-Ryder
15 cm
0416-15TC



TC Halsey
13 cm
0408-13TC

NEEDLE HOLDERS

NEEDLE HOLDERS

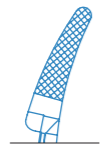

Gillies
scissors combined
16 cm
0414-16

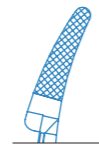

TC Gillies
scissors combined
16 cm
0419-16TC

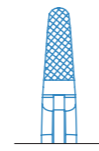

TC Fine Swedish
15 cm
0417-15TC

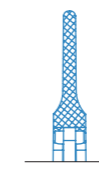

Lichtenberg
smooth action
17 cm
0432-17

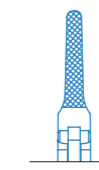

TC Lichtenberg
17 cm
0437-17TC

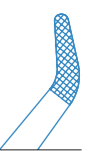

Eiselberg-Mathieu
19,5 cm
0422-19

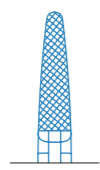

Toennis
light pattern
18 cm
0421-18

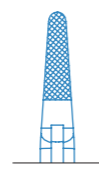

TC Toennis
light pattern
18 cm
0426-18TC

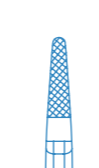

TC Micro-Vascular
15 cm
0418-15TC

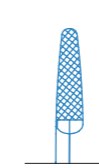

Arruga
16 cm
0433-16

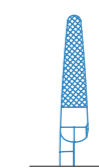

TC Arruga
16 cm
0438-16TC

NEEDLE HOLDERS

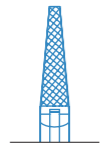

Mathieu
14 cm
0430-14

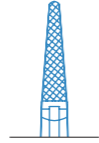

Mathieu
14 cm
0431-14

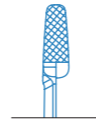

Mathieu
scissors combined
14 cm
0432-14

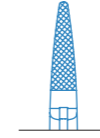

TC Mathieu
14 cm
0435-14TC

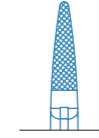

TC Mathieu
14 cm
0436-14TC

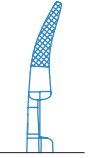

TC Micro-Barraquer
with curved jaws
18 cm
0451TH-18TC

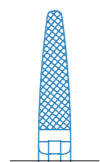

Mathieu
17 cm
0430-17

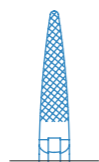

Mathieu
17 cm
0431-17



TC Mathieu
14 cm
0432-14TC

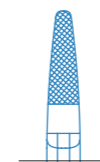

TC Mathieu
17 cm
0435-17TC

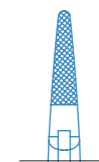

TC Mathieu
17 cm
0436-17TC

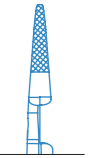

TC Micro-Barraquer
18 cm
0450TH-18TC

NEEDLE HOLDERS

NEEDLE HOLDERS



TC Castroviejo
with curved jaws
15.5 cm
PR0460-15TC



Castroviejo
14 cm
0440TH-14



Castroviejo
with curved jaws
14 cm
0441TH-14



Castroviejo
14 cm / 60°
0443TH-14



Castroviejo
13 cm
0442TH-13



Castroviejo
smooth jaws
13 cm
0442TH-13L



Castroviejo-Barraquer
smooth jaws
12 cm
0444TH-12L



TC Castroviejo
13 cm
0447TH-13TC



TC Castroviejo
14 cm
0445TH-14TC



TC Castroviejo
14 cm
0446TH-14TC



TC Castroviejo
14 cm / 60°
0448TH-14TC



Castroviejo
18 cm
0440TH-18



Castroviejo
with curved jaws
18 cm
0441TH-18



TC Castroviejo
18 cm
0445TH-18TC



TC Castroviejo
18 cm
0446TH-18TC

HEMOSTATS



1 Crile
straight
14 cm
0520-1



2 Crile
curved
14 cm
0520-2



1 Kocher 1x2
straight
14 cm
0530-1



2 Kocher 1x2
curved
14 cm
0530-2



1 Pean
straight
14 cm
0540-1



2 Pean
curved
14 cm
0540-2



1 Halstead-Mosquito
straight
12 cm
0500-1

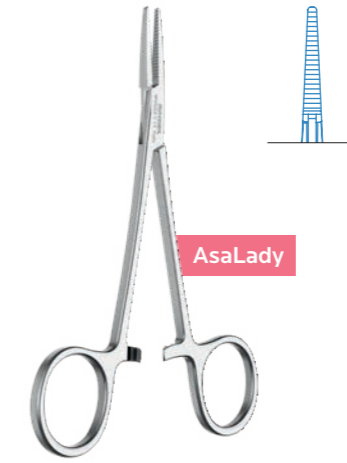

1 Halstead-Mosquito
straight
12 cm
W0502-1



2 Halstead-Mosquito
curved
12 cm
0500-2

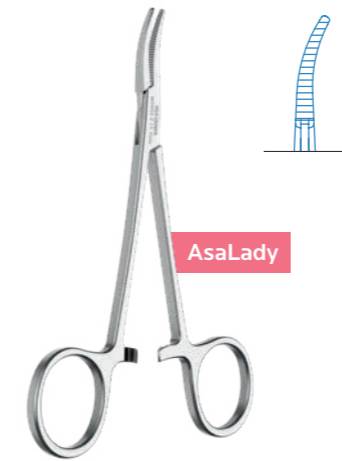

2 Halstead-Mosquito
curved
12 cm
W0502-2

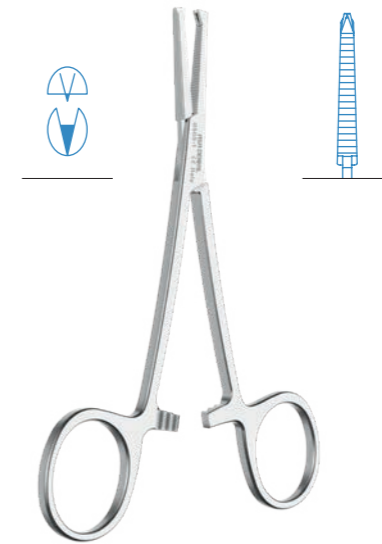

1 Halstead-Mosquito 1x2
straight
12 cm
0505-1

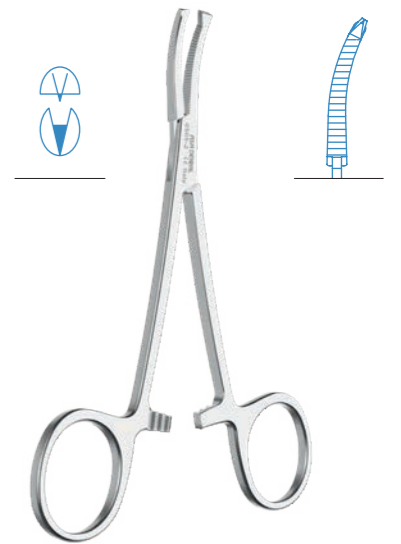

2 Halstead-Mosquito 1x2
curved
12 cm
0505-2

HEMOSTATS

HEMOSTATS

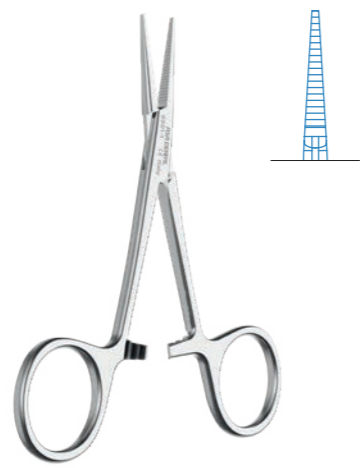

1 Micro-Mosquito
straight
10 cm
0501-1

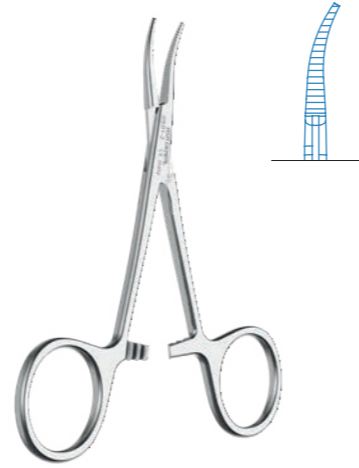

2 Micro-Mosquito
curved
10 cm
0501-2

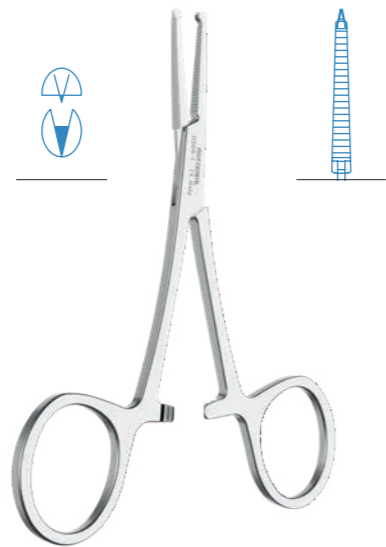

1 Micro-Mosquito 1x2
straight
10 cm
0506-1

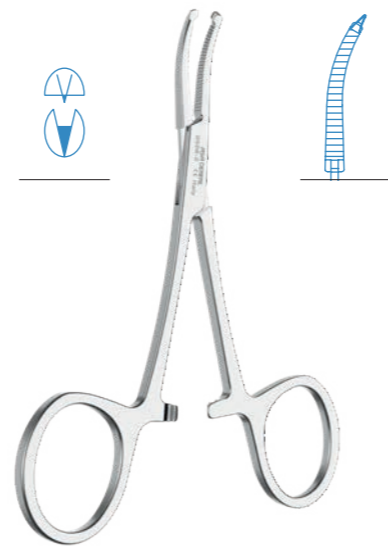

2 Micro-Mosquito 1x2
curved
10 cm
0506-2

HEMOSTATS



1 Kelly
straight
14 cm
0510-1



2 Kelly
curved
14 cm
0510-2



1 Hartmann
straight
10 cm
0515-1



2 Hartmann
curved
10 cm
0515-2



ORIENTABLE
BLADE SCALPEL
HANDLES



16 cm
0335-1
(pair of instruments)

BLADE REMOVER



16.5 cm
0352



S0352
kit of
0352
blade remover +
0335-1
(pair of instruments)
orientable blade scalpel handles

DISPOSABLE SCALPELS

10 pcs / box

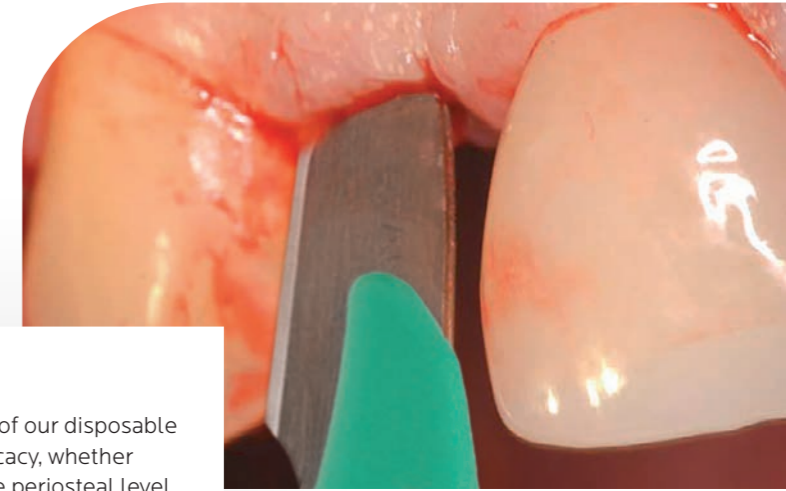

0371-10

Sharp and thin, the blades of our disposable scalpels maintain their efficacy, whether used superficially or at the periosteal level.



0371-10



0371-11



0371-12



0371-15

SCALPEL HANDLES

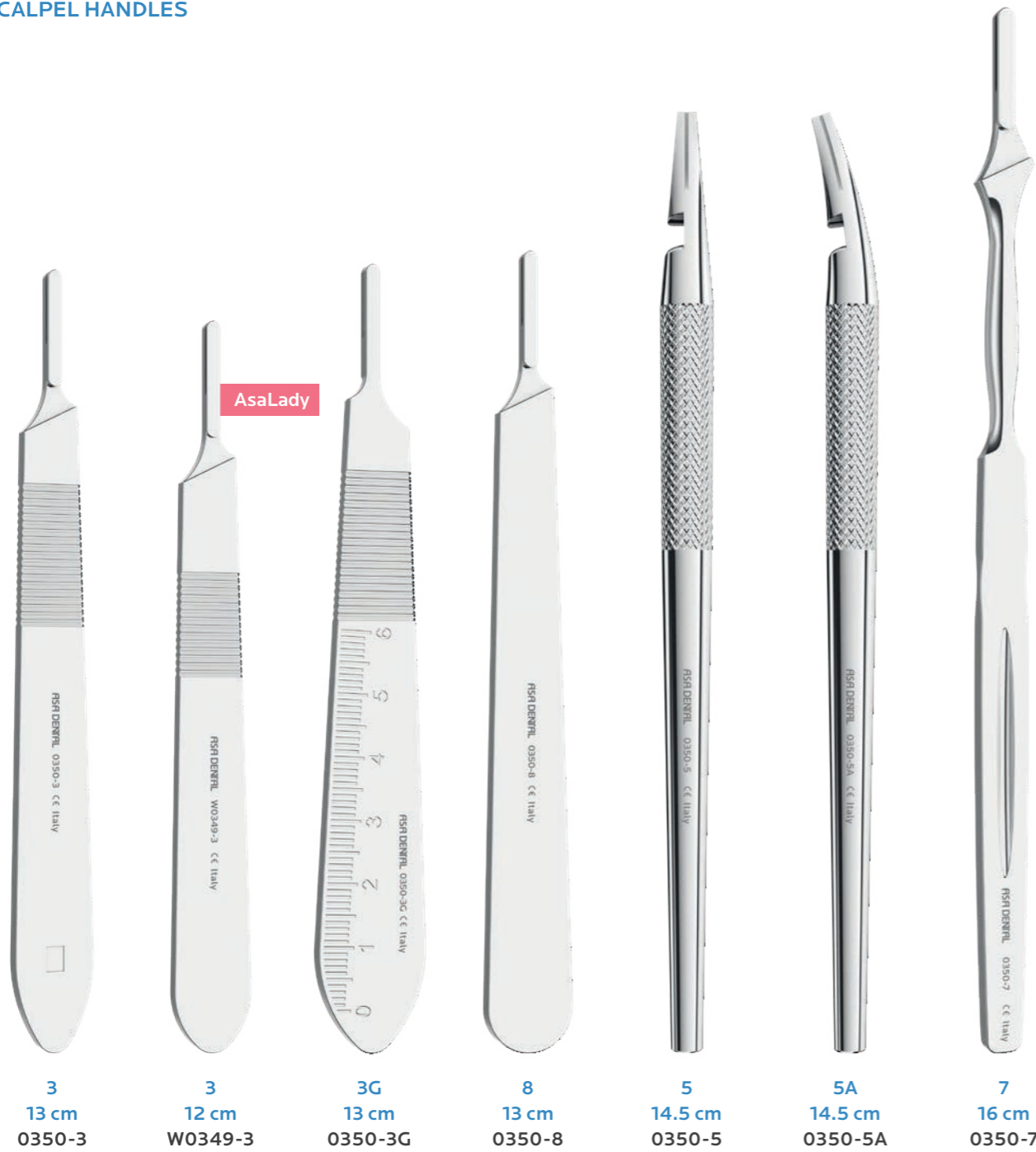

SCALPEL BLADES ☺

100 pcs (sterile) / box



SCALPEL HANDLES



SCALPEL BLADES ☺

100 pcs (sterile) / box

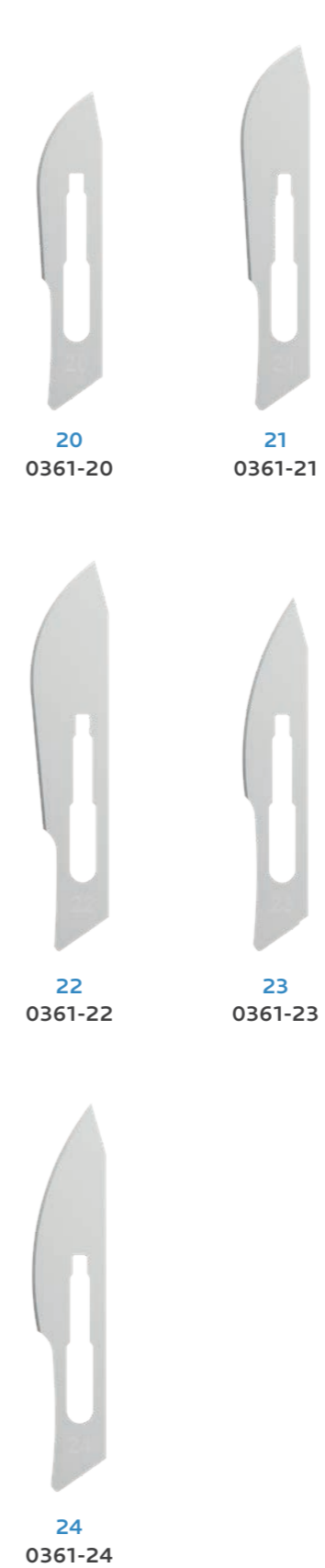

MICRO-BLADES ☺

25 pcs (sterile) / box

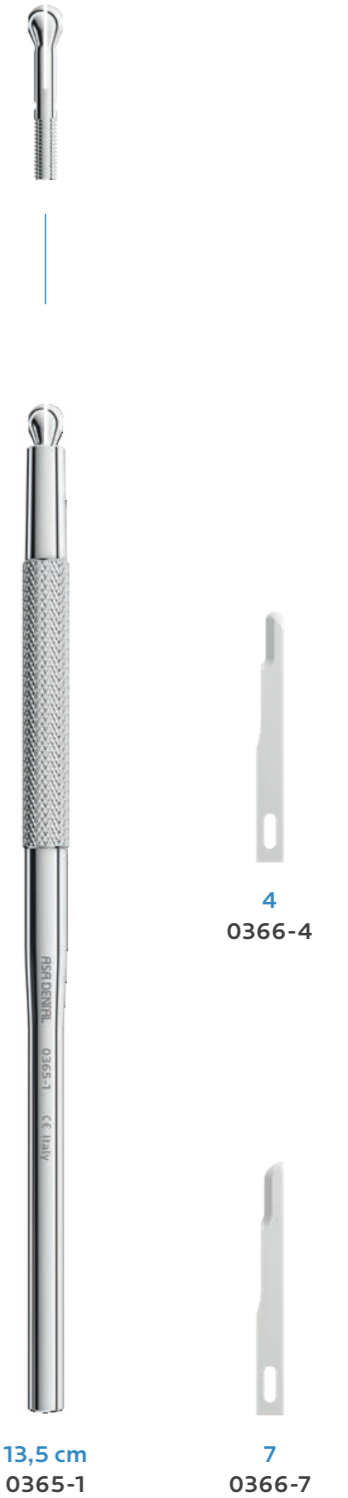

DENTAL SYRINGES

manual aspiration

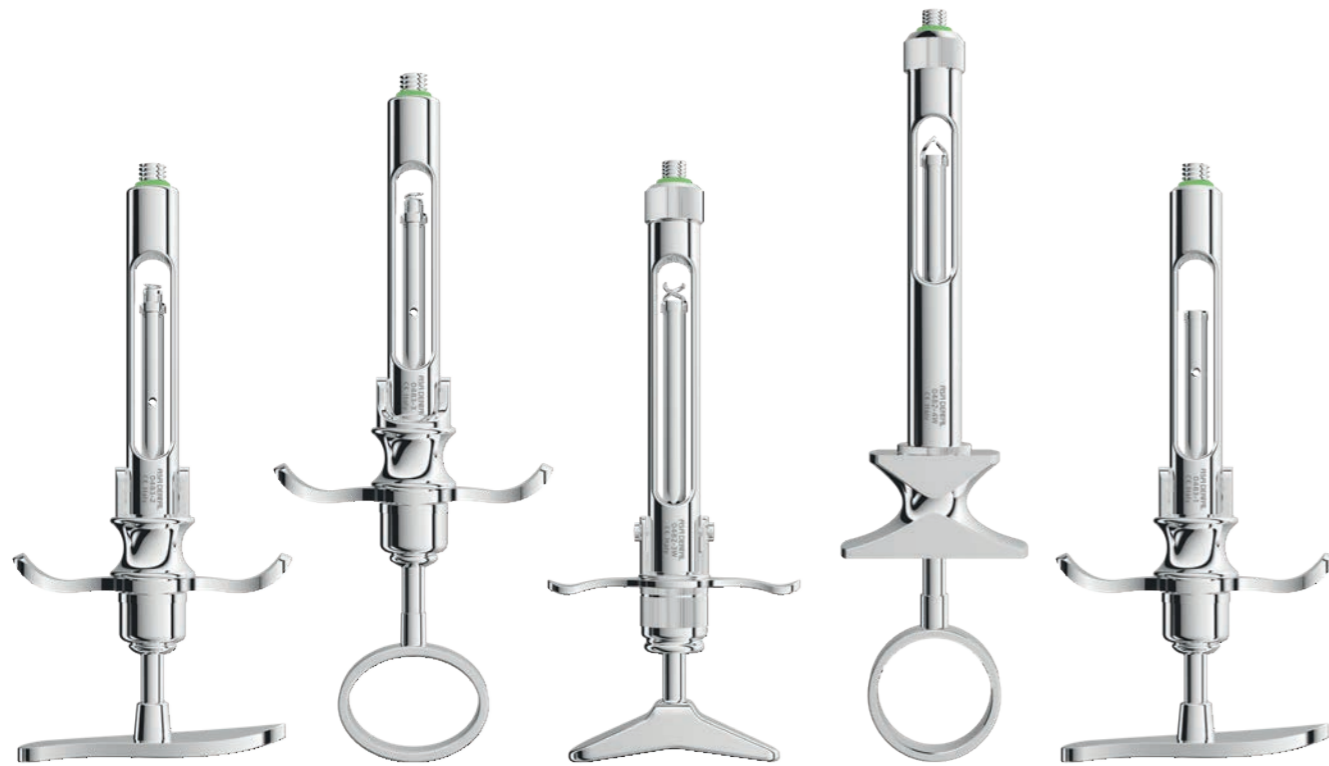

1.8 ml cartridge
metric thread
0483-2

1.8 ml cartridge
metric thread
0483-3

2.2 ml cartridge
Whitworth thread
0482-3W

2.2 ml cartridge
imperial thread
(Whitworth)
0482-4W

1,8 ml cartridge
metric thread
0483-1

DENTAL SYRINGES

cork screw tip



1.8 ml cartridge
metric thread
0480-1

1.8 ml cartridge
metric thread
0480-2

1.8 ml cartridge
metric thread
0480-4

self-aspirating



1,8 ml cartridge
metric thread
0480-5

1,8 ml cartridge
metric thread
0480-6

2,2 ml cartridge
Whitworth thread
0482-6W

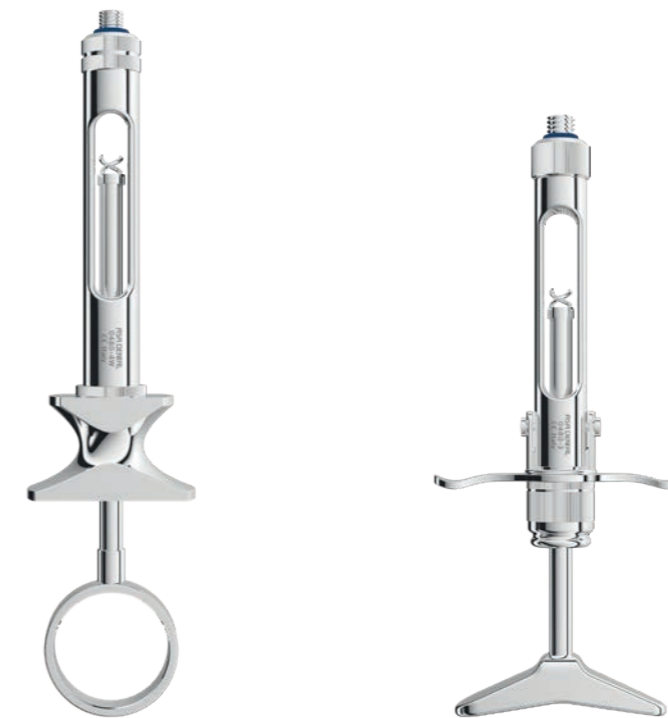

1.8 ml cartridge
Whitworth thread
0480-4W

1.8 ml cartridge
metric thread
0480-3

Spare caps for

- 0480-1
- 0480-2
- 0480-3
- 0480-4



metric thread
0480-P1



Whitworth thread
0480-P2

DENTAL SYRINGES

intra-ligamentary anesthesia

Stainless steel syringe

1.8 ml cartridge
metric thread
0481-8



Brass syringes
with stainless steel
moving parts



2.2 ml cartridge
Whitworth thread
0482-7W



1.8 ml cartridge
metric thread
0481-7

Autoclavable plastic protection sleeve



0481-T1

Syringe stand



0482-1

TOWEL CLAMPS



1 Backhaus
8 cm
0550-1



2 Backhaus
11 cm
0550-2



3 Backhaus
13 cm
0550-3



Schaedle
9 cm
0680



Jones
9 cm
0681

DRESSING FORCEPS



Gross-Maier
straight
20 cm
0555-1

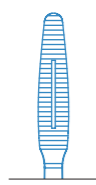

Gross-Maier
curved
20 cm
0555-2



Gross-Maier
straight
25 cm
0557-1

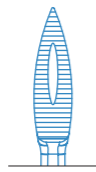

Gross-Maier
curved
25 cm
0557-2



MOUTH GAGS

For adults



Molt
14 cm
1870-2



Roser-Koenig
19 cm
1871-2

For children



Molt
11 cm
1870-1



Roser-Koenig
16 cm
1871-1

TONGUE HOLDING FORCEPS



Collin
16 cm
0560



0561-R



Young
17 cm
0561

RETRACTORS

Lip retractors



Columbia
14.5 cm
2601

Sternberg
14 cm
2602-1

Sternberg
16 cm
2602-2

Sternberg
14 cm
2602-3

Orringer medium
11 x 8 cm
2609-2

Tongue depressors



14 cm
2605

17 cm
2606

Buchwald
17 cm
2607

Brünings
19 cm
2608

Cheek retractor



University of Minnesota
14 cm
2604

RETRACTORS



blunt
16 cm
2611-1

blunt
16 cm
2611-2

Senn-Miller
sharp
15,5 cm
2613-1

Senn-Miller
blunt
16 cm
2613-2

Kilner
15 cm
2615-1

Farabeuf
13 cm
2616-1



Williger
left
sharp
13 cm
2617-2

Williger
right
sharp
14 cm
2617-3

Williger
straight
blunt
13 cm
2618-1

Williger
left
blunt
13 cm
2618-2

RETRACTORS



Nasal spine ramus retractors



RETRACTORS



Lip retractor

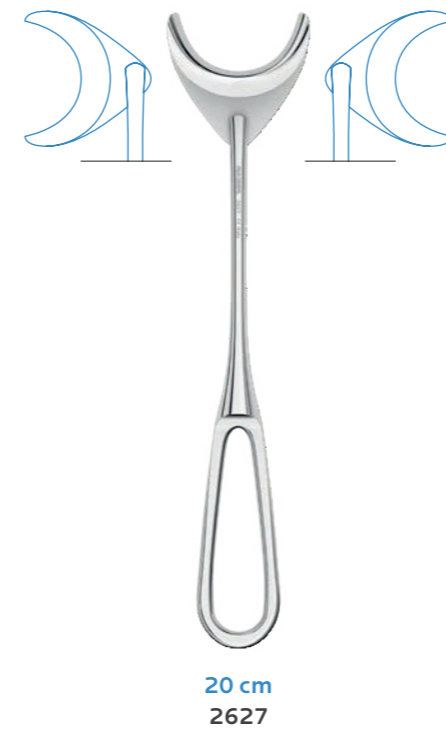

LACRIMAL PROBES

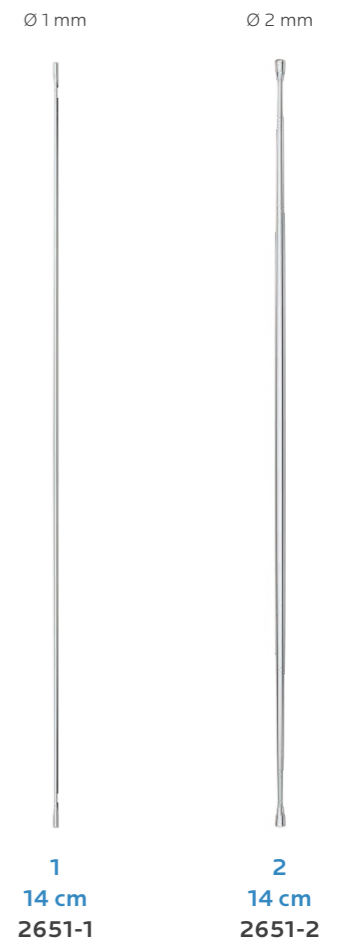

TISSUE PLIERS

PR0632-1

Atraumatic tissue pliers with thin tips

Ideal pliers for handling tissue and facilitating suturing procedures.



0,8 mm



Cooley
17.5 cm
PR0632-1



1 Adson
12 cm
0620-1



1 Adson 1x2
12 cm
0621-1



1 Micro-Adson 1x2
12 cm
0622-1



2 Micro-Adson 1x2
15 cm
0622-2



10 cm
0623-1



Micro-Adson
12 cm
0624-1



Micro-Adson
15 cm
0624-2

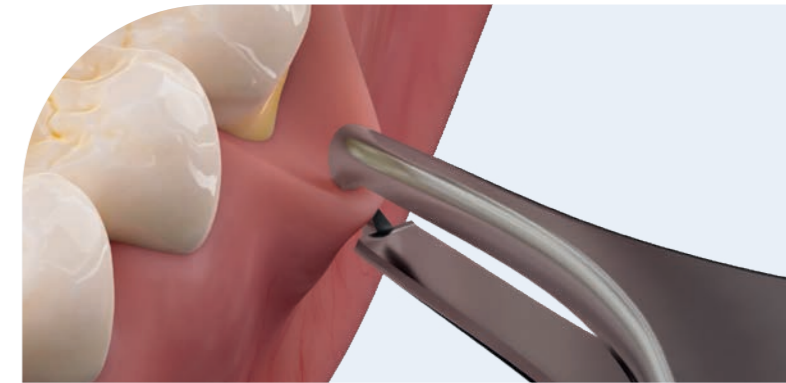

0622-2

TISSUE PLIERS

TISSUE PLIERS
suture pliers

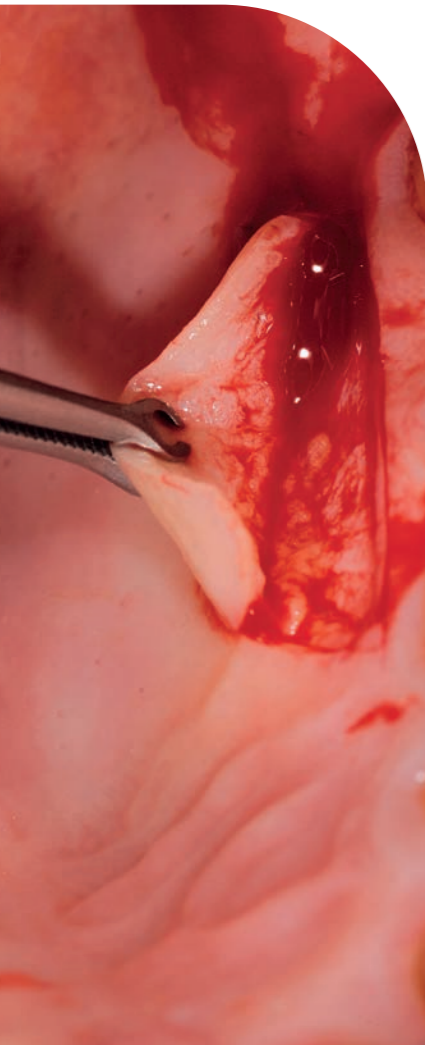

PR0625-3
Allows atraumatic manipulation of the soft tissue and facilitates suturing.

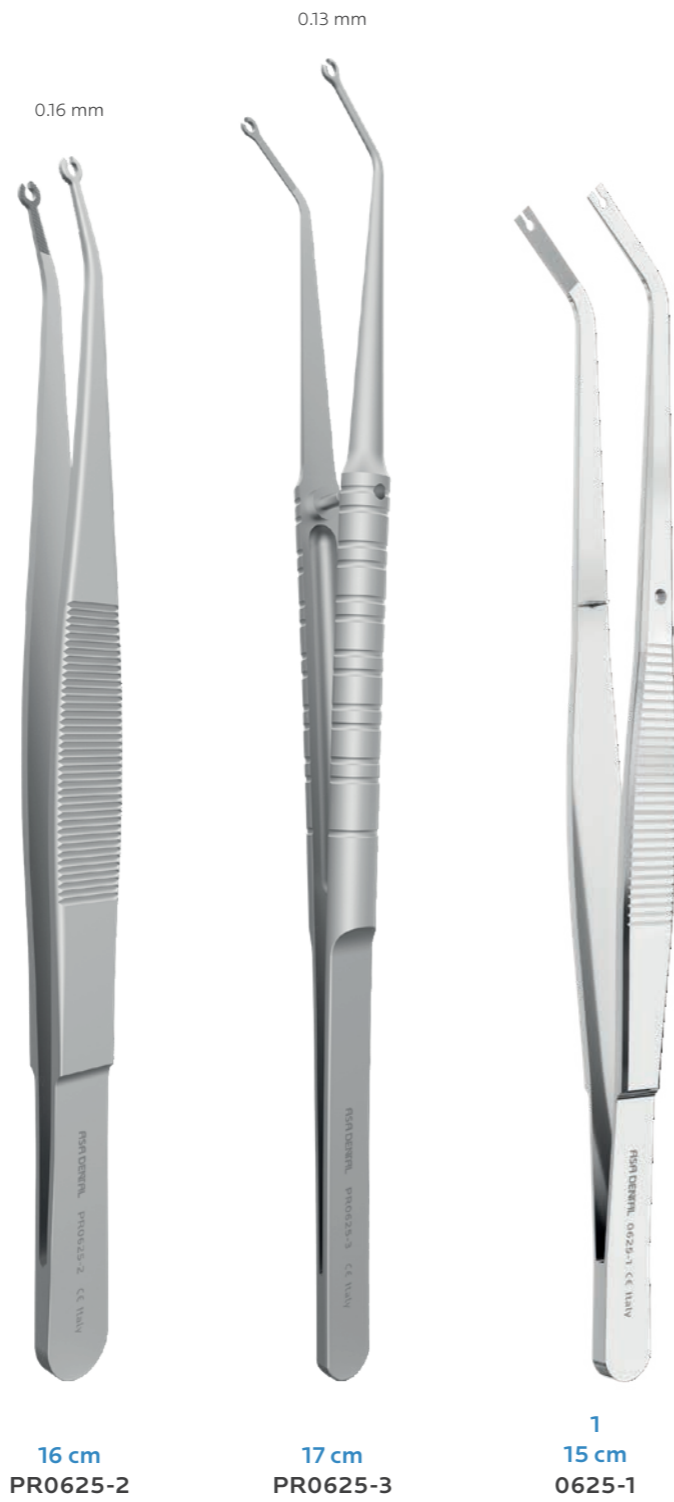

TISSUE PLIERS



TISSUE PLIERS

very thin tips

Set of 5



1 · 2 · 3 · 4 · 5
S0645



1
12.5 cm
0645-1



2
12 cm
0645-2



3
11.5 cm
0645-3



4
11.5 cm
0645-4



5
11.5 cm
0645-5



1
13 cm
0635-1



2
14 cm
0635-2



3
15 cm
0635-3



4
18 cm
0635-4



5
20.5 cm
0635-5

TISSUE PLIERS

SURGICAL STAINLESS STEEL SALIVA EJECTORS



BONE CURETTES

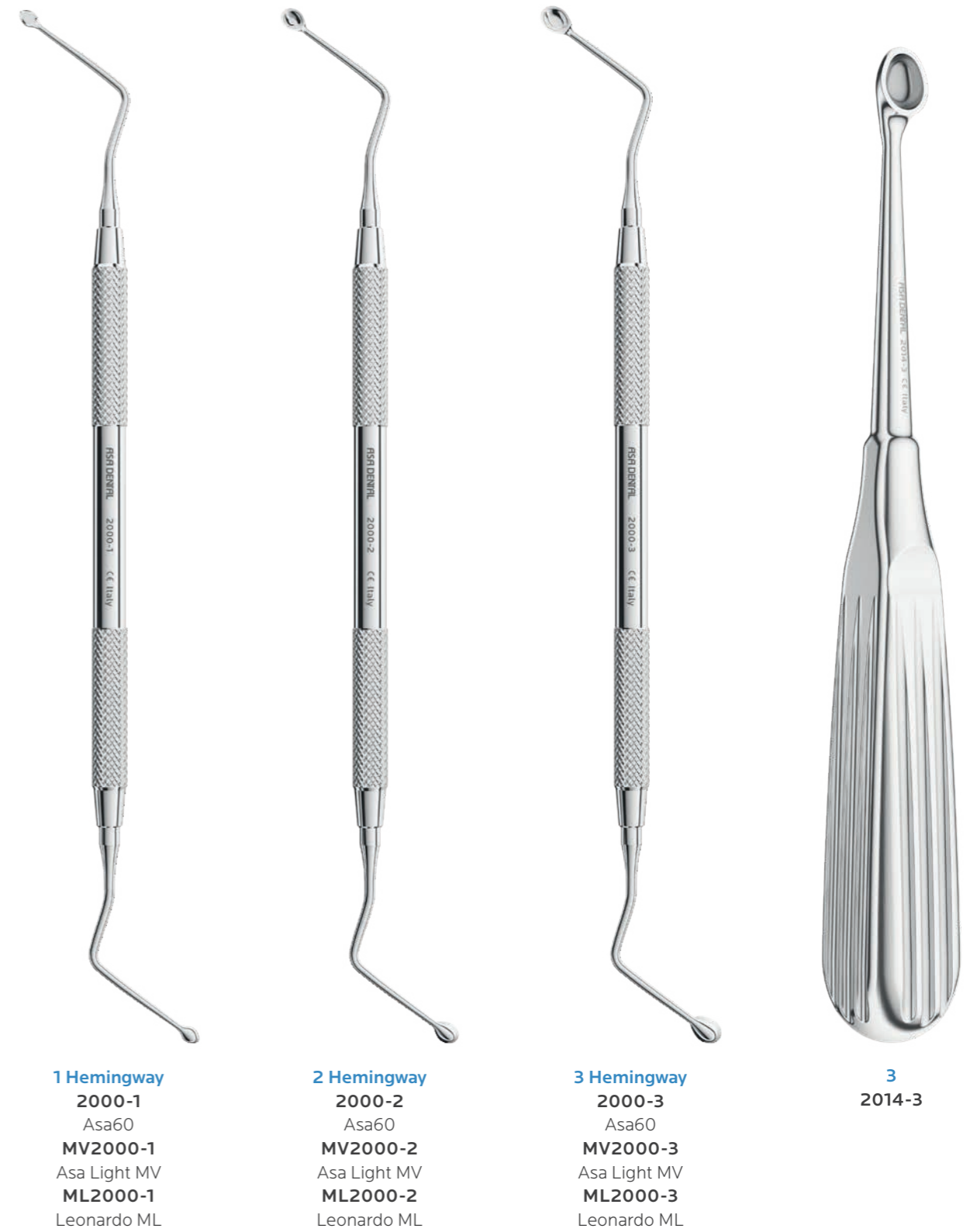

1 Hemingway
2000-1
Asa60
MV2000-1
Asa Light MV
ML2000-1
Leonardo ML

2 Hemingway
2000-2
Asa60
MV2000-2
Asa Light MV
ML2000-2
Leonardo ML

3 Hemingway
2000-3
Asa60
MV2000-3
Asa Light MV
ML2000-3
Leonardo ML

3
2014-3

INSTRUMENT KIT FOR ORAL SURGERY

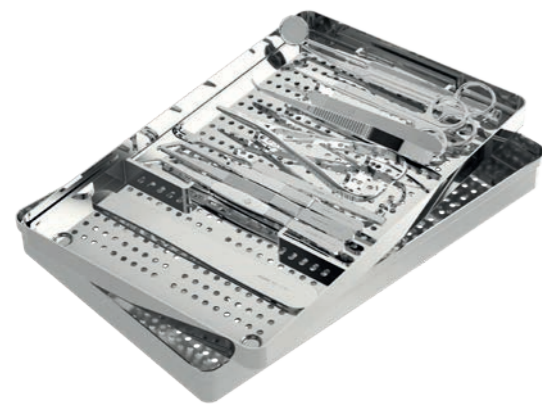

S3002-13

0602-2	cotton and dressing pliers	2
0635-3	tissue pliers	3
0625-1	suture pliers	1
2611-2	retractor	
0430-14	Mathieu needle holder	
0441TH-14	Castroviejo needle holder	
0350-3	scalpel handle	
0320-2	straight Spencer surgical scissors	
0321-2	curved Metzenbaum surgical scissors	2
2102-IN	mouth mirror handle	
2607	Buchwald retractor	
2200-4	plane mouth mirror	4
S2722-1	perforated instrument tray complete with insert frame	

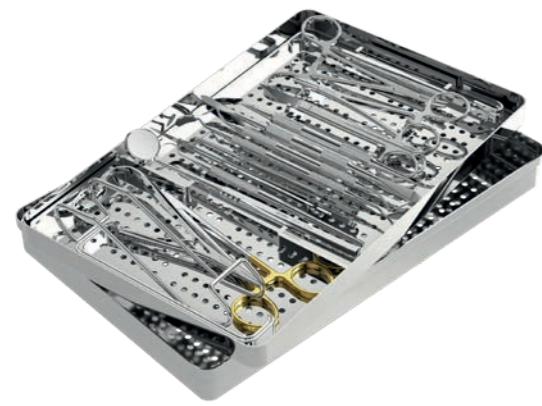

S3002-17

2102-IN	mouth mirror handle	
0700-23	explorer with an anatomic handle	23
0601-2	London-College cotton and dressing pliers	2
0631-1	Semken-Taylor tissue pliers	1
1815-7	Goldman-Fox knives	7
1804-D	Orban knives	1/2
MV1850-M9	Molt periosteal elevator	M9
MV1851-PR3	Prichard periosteal elevator	PR3
2616-1	Farabeuf retractor	
2602-1	Sternberg retractor	
2613-2	Senn-Miller retractor	
0415-15TC	Crile-Wood needle holder	
0430-14	Mathieu needle holder	
0304-2	curved Goldman-Fox scissors	2
0500-1	straight Halstead-Mosquito hemostats	1
0500-2	curved Halstead-Mosquito hemostats	2
2200-5	plane mouth mirror	5
S2722-1	perforated instrument tray complete with insert frame	

INSTRUMENT KIT FOR ORAL SURGERY



S3002-18

MV1807-08	Gracey curette	7/8
MV1807-12	Gracey curette	11/12
MV1807-14	Gracey curette	13/14
0304-1	straight Goldman-Fox scissors	1
0304-2	curved Goldman-Fox scissors	2
MV2001-85	Lucas bone curette	85
MV2001-86	Lucas bone curette	86
MV1803-D	Kirkland knives	1/2
MV1804-D	Orban knives	1/2
MV1850-M9	Molt periosteal elevator	M9
MV1851-PR3	Prichard periosteal elevator	PR3
0350-5	straight scalpel handle	5
0350-5A	curved scalpel handle	5A
1800-1	Ochsenbein chisel	1
1800-2	Ochsenbein chisel	2
0445TH-14TC	Castroviejo needle holder	
0435-14TC	Mathieu needle holder	
S2722-2	perforated instrument tray complete with insert frame	

EXTRACTIVE SURGERY

MADE IN ITALY



RESOLVING THE PRESENT, DESIGNING THE FUTURE

Removing a tooth is always an extreme measure that is usually adopted to resolve a painful situation for the patient. Even the simplest extractions demand the most careful maneuvers, aiming at preserving the bone as much as possible and not compromising the possibility of future implants.

However, experienced professionals and medical literature alike report cases requiring far more complex procedures. A molar broken off at the gum line, an included or semi-included wisdom tooth, a non-erupting molar: an extraction can turn

into real surgery with the need to create an access point through the gum and minimize the amount of sacrificed bone. Being minimally invasive and extremely precise requires a broad range of superior high-performance instruments, including a large variety of levers that meet all potential needs.

- D4** Extracting forceps
- D37** Extracting forceps for children
- D40** Root and splinter forceps
- D42** Bone rongeurs
- D44** Bone/soft tissue nippers
- D45** Root elevators
- D46** Atraumatic luxators
- D64** Root-tip picks
- D67** Syndesmotomes
- D70** Exciser
- D70** Periotomes
- D71** Surgery kit
- D73** Accessories



EXTRACTING FORCEPS - RANGE OF APPLICATION

HOW TO USE THE INFORMATION

AsaLady

products ergonomically designed for women's hands:

- smaller and lighter handles
- smaller finger holes
- reduced size
- code starts with "W" or "SW"

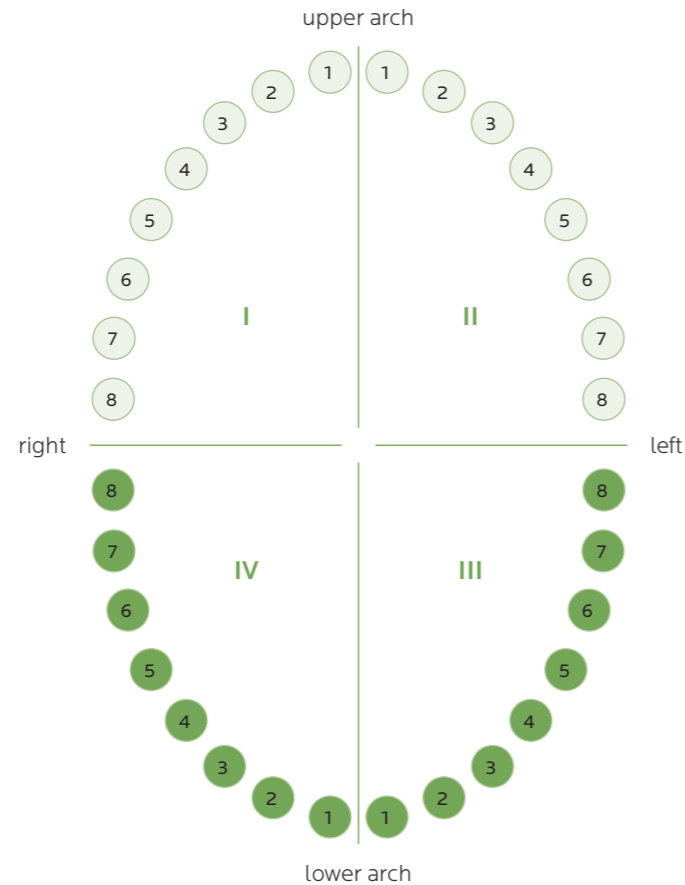
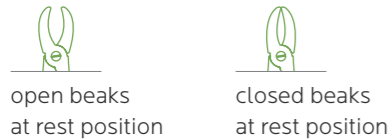
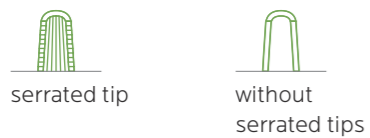
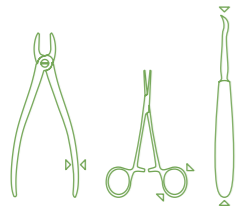

all forceps have an international designation symbol for better identification

		Incisors and Canines		Pre-molars		Molars		Roots		Wisdom teeth		For Children	
		lower	upper	lower	upper	lower	upper	lower	upper	lower	upper	lower	upper
0100-1	W0160-1		●										
0100-2	W0160-2		●										
0100-3			●										
0100-4	W0160-4	○											
0100-7	W0160-7				●								
0100-8				○									
0100-13	W0160-13			○									
0100-17	W0160-17					●							
0100-18	W0160-18					●							
0100-18A						●							
0100-19										●			
0100-20										○			
0100-21	W0160-21						○						
0100-22	W0160-22						○						
0100-22L							○						
0100-22R							○			○			
0100-23							○						
0100-24							○						
0100-29								●					
0100-29N								●					
0100-30								●					
0100-31		○						○					
0100-33	W0160-33							○					
0100-33A								○					
0100-33L								○					
0100-38A								○					
0100-41								○					
0100-43A								○					
0100-44								○					
0100-45	W0160-45							○					
0100-46								○					
0100-46L								○					
0100-48								○					
0100-49								○					
0100-51								○					
0100-51A	W0160-51A							○					
0100-51L								○					
0100-51LX								○					
0100-52			●					○					
0100-54							●						
0100-55							○						
0100-56							○						
0100-59								○					
0100-59L		○						○					
0100-60								○					
0100-65L							●						
0100-65R							●						
0100-66L							●						
0100-66R							●						
0100-67								○					
0100-67A	W0160-67A							○					
0100-67/L								○					
0100-67/R								○					
0100-68								○					
0100-73							○						
0100-74	W0160-74							○					
0100-74M			●					○					
0100-74N								○					
0100-75			○										
0100-79	W0160-79								○				
0100-79A									○				
0100-79C									○				
0100-86/L									○				
0100-86/R									○				
0100-86C	W0160-86C						○						
0100-86W									○				
0100-87							○						
0100-89							○						
0100-90							○						
0100-99							○						
0100-107			●										
0100-121									○				
0100-145	W0160-145							○					
0100-151/	W0160-151/							○					
0100-166										●			
0100-167										○			
0100-168			●										
0100-169		○											
0100-346											○		
0100-349											●		
0100-359											○		
0104-1			●										
0104-2											●		
0104-3		○									○		
0104-4											○		
0120-5	W0121-5											○	
0120-6	W0121-6										○		
0120-10S	W0121-10S										○		
0120-16	W0121-16										○		
0120-17	W0121-17										○		
0120-18L	W0121-18L										○		
0120-18R	W0121-18R										○		
0120-23	W0121-23										○		
0120-53R	W0121-53R										○		
0120-53L	W0121-53L										○		
0120-65	W0121-65										○		
0120-69	W0121-69										○		
0120-88R	W0121-88R										○		
0120-88L	W0121-88L										○		
0120-101	W0121-101										○		
0120-150	W0121-150										○		
0120-150S	W0121-150S										○		
0120-151	W0121-151	○									○		
0120-151S	W0121-151S										○		
0120-222	W0121-222										○		
0130-1													
0130-2													
0130-4		○											
0130-7													
0130-13											○		
0130-17											○		
0130-18											○		
0130-21											○		
0130-22											○		
0130-33											○		
0130-45											○		
0130-51A											○		
0130-67A											○		
0130-74											○		
0130-79											○		
0130-86C											○		
0130-89											○		
0130-90											○		
0130-145											○		
0130-151/											○		
0130-349											○		
0130-359											○		
0110-37													●
0110-39													●
0110-39R													●
0110-39L													●
0110-51S													●
0110-13S												○	
0110-22S												○	
0110-30S												○	
0110-33S												○	
0110-38												○	
0112-1		○											●
0112-2													●
0112-3													●
0112-4													●
0112-5		○											○
0112-6													○
0112-7													○
0101-1													○
0101-2													○
0102-1													○
0102-2													○

EXTRACTING FORCEPS

serrated tips



S0100-1

0100-1	1
0100-17	17
0100-18	18
0100-79	79
0100-67A	67A
0100-51A	51A
0100-13	13
0100-22	22



1
17.5 cm
0100-1
upper incisors and canines



2
17 cm
0100-2
upper incisors and canines



3
17 cm
0100-3
overlapping upper incisors and canines



4
15.5 cm
0100-4
lower incisors and canines



7
16.5 cm
0100-7
upper incisors
upper premolars



8
16 cm
0100-8
lower premolars

EXTRACTING FORCEPS

serrated tips



S0100-2

0100-1	1
0100-7	7
0100-17	17
0100-18	18
0100-4	4
0100-13	13
0100-22	22
0100-86C	86C



13
16 cm
0100-13
lower premolars



17
16 cm
0100-17
upper right molars



18
16.5 cm
0100-18
upper left molars



18A
16.5 cm
0100-18A
upper molars



20
16 cm
0100-20
lower wisdom teeth



21
16 cm
0100-21
lower molars

EXTRACTING FORCEPS
serrated tips



19
15 cm
0100-19
upper wisdom teeth



22
15 cm
0100-22
lower molars



22L Routurier
17.5 cm
0100-22L
left lower molars
and wisdom teeth



22R Routurier
17.5 cm
0100-22R
lower right molars
and wisdom teeth



23
15 cm
0100-23
lower right molars



24
15 cm
0100-24
left lower molars



29
17.5 cm
0100-29
upper roots



29N
17.5 cm
0100-29N
upper roots and incisors

EXTRACTING FORCEPS

serrated tips



30
17 cm
0100-30
upper roots



31
16 cm
0100-31
lower roots and incisors

33
15 cm
0100-33
lower roots



33A
15 cm
0100-33A
lower roots

33L
15 cm
0100-33L
lower roots



38A
15 cm
0100-38A
fractured or decayed
lower teeth

41
19 cm
0100-41
upper roots

EXTRACTING FORCEPS

serrated tips



43A
16.5 cm
0100-43A
fractured or decayed
upper teeth



0100-45
Curved extracting forceps with
serrated rims for lower roots.



44
18.5 cm
0100-44
upper roots

45
18.5 cm
0100-45
lower roots

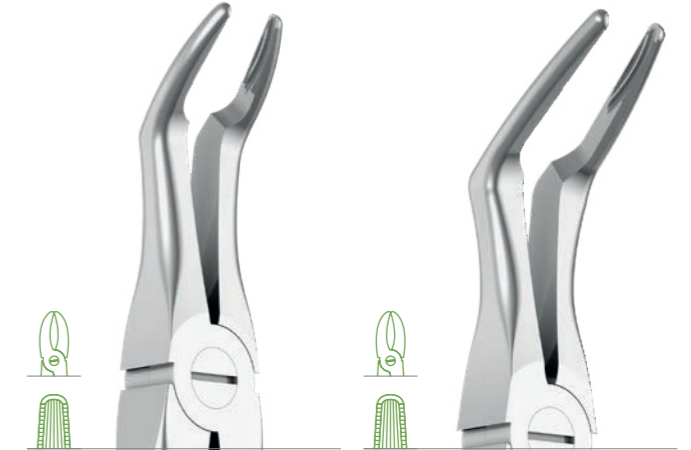

46
18.5 cm
0100-46
lower roots

46L
19 cm
0100-46L
lower roots

EXTRACTING FORCEPS

serrated tips



48
18.5 cm
0100-48
upper roots



49
18.5 cm
0100-49
upper roots



51L
18.5 cm
0100-51L
upper roots



51
18 cm
0100-51
upper roots



51A
17.5 cm
0100-51A
upper roots



51LX
19 cm
0100-51LX
upper roots



52
18 cm
0100-52
upper roots
and canines



54
17 cm
0100-54
for separating
upper molars



55
16.5 cm
0100-55
for separating
upper molars



56
15.5 cm
0100-56
for separating
lower molars



59
15 cm
0100-59
lower roots



59L
16 cm
0100-59L
lower incisor roots

EXTRACTING FORCEPS
serrated tips



60
15 cm
0100-60
lower roots



65L
17 cm
0100-65L
upper left molars



65R
17 cm
0100-65R
upper right molars



66L
17 cm
0100-66L
upper left molars

EXTRACTING FORCEPS
serrated tips



66R
17 cm
0100-66R
upper right molars



67
18.5 cm
0100-67
upper wisdom teeth



67A
18.5 cm
0100-67A
upper wisdom teeth



67 1/2 L
18.5 cm
0100-67/L
upper left wisdom teeth



67 1/2 R
18.5 cm
0100-67/R
lower right incisor roots

EXTRACTING FORCEPS
serrated tips



EXTRACTING FORCEPS
serrated tips



EXTRACTING FORCEPS
without serrated tips



86 1/2L Routurier
17.5 cm
0100-86/L
left lower wisdom teeth

86 1/2R Routurier
17.5 cm
0100-86/R
lower right wisdom teeth

86C
16 cm
0100-86C
lower molars

EXTRACTING FORCEPS
without serrated tips



86W White
16.5 cm
0100-86W
for lower last molar

87
16 cm
0100-87
lower decayed molars or
broken crowns

166 Trotter
17 cm
0100-166
universal extracting forceps
for upper teeth, in particular
molars and premolars

EXTRACTING FORCEPS
serrated tips



89
18 cm
0100-89
upper right molars

90
18 cm
0100-90
upper left molars

99
16 cm
0100-99
lower molars with
broken crowns

EXTRACTING FORCEPS
serrated tips

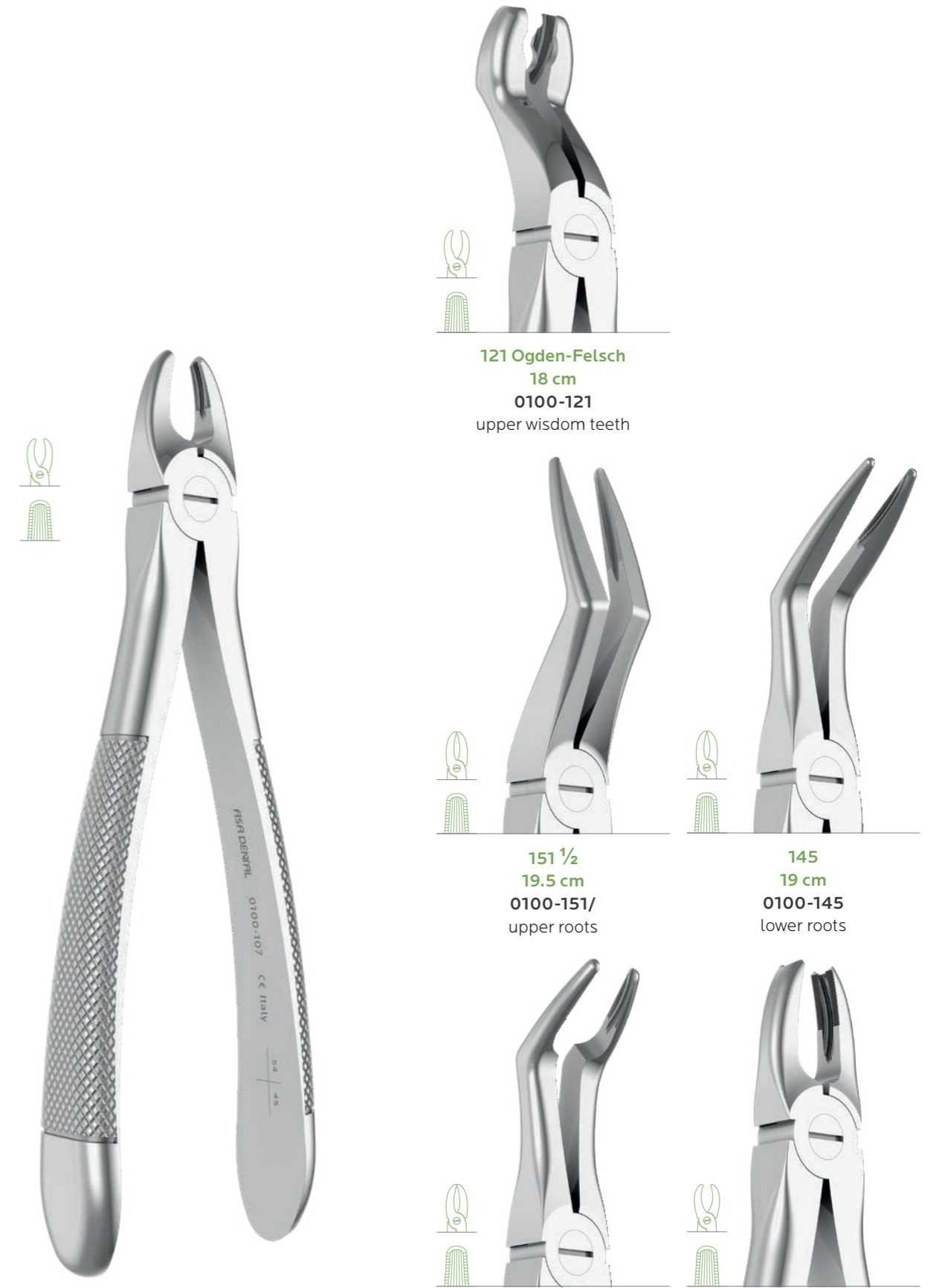

107
16.5 cm
0100-107
upper canines

121 Ogden-Felsch
18 cm
0100-121
upper wisdom teeth

151 1/2
19.5 cm
0100-151/
upper roots

145
19 cm
0100-145
lower roots

346
18.5 cm
0100-346
lower roots

168 Trotter
16.5 cm
0100-168
upper canines

EXTRACTING FORCEPS

without serrated tips



167 Trotter
16 cm
0100-167
universal extracting forceps for lower teeth, in particular molars and premolars

serrated tips



169 Trotter
16 cm
0100-169
upper wisdom teeth



359
16 cm
0100-359
lower roots



349
19 cm
0100-349
upper roots

EXTRACTING FORCEPS - ASALADY

serrated tips



1
16 cm
W0160-1
upper incisors and canines



2
16 cm
W0160-2
upper incisors and canines

4
14.5 cm
W0160-4
lower incisors and canines



7
15.5 cm
W0160-7
upper incisors
upper premolars

13
14 cm
W0160-13
lower premolars

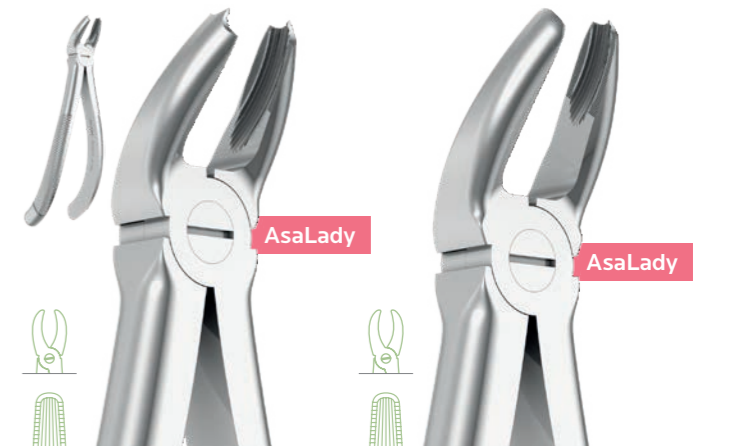

17
15 cm
W0160-17
upper right molars

18
15.5 cm
W0160-18
upper left molars

EXTRACTING FORCEPS - ASALADY
serrated tips

EXTRACTING FORCEPS - ASALADY
serrated tips

without serrated tips

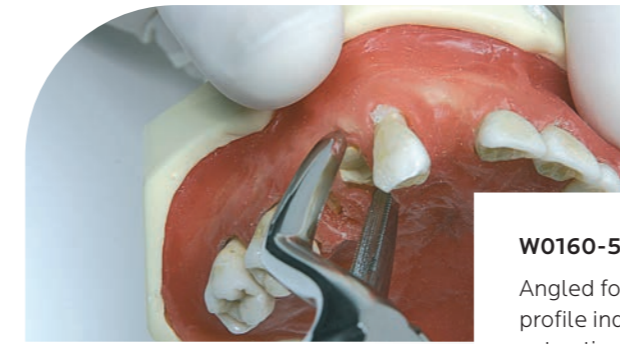
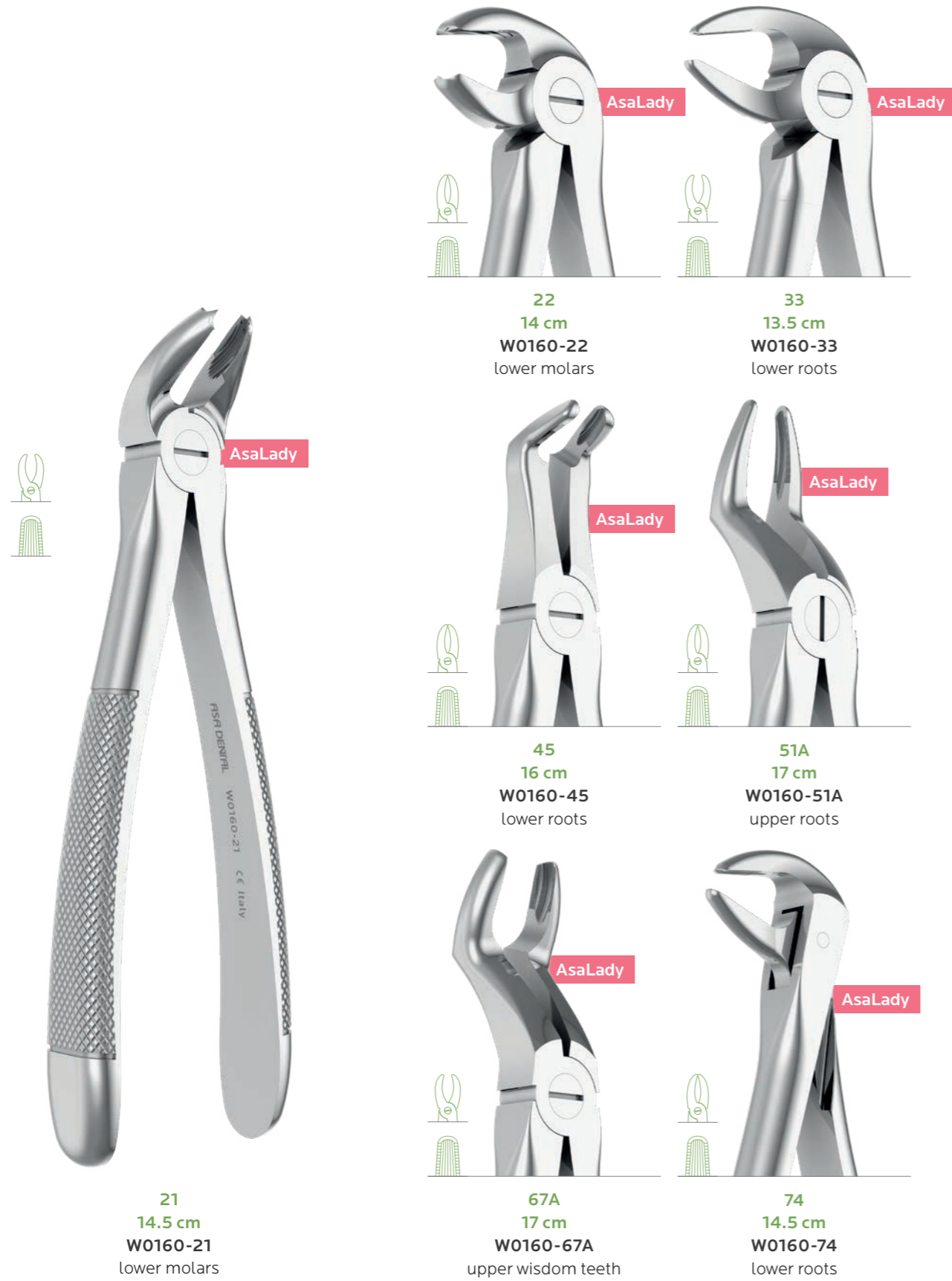

W0160-51A
Angled forceps with retention profile indicated for the extraction of upper roots.



EXTRACTING FORCEPS - MEAD PATTERN

serrated tips



1
17 cm
0104-1
universal extracting forceps
for upper incisors and canines



2
16.5 cm
0104-2
upper molars



3
15 cm
0104-3
lower incisors,
premolars and roots



4
15 cm
0104-4
lower molars

EXTRACTING FORCEPS - AMERICAN PATTERN

without serrated tips



5 Physick
17.5 cm
0120-5
lower wisdom teeth



6
17 cm
0120-6
separating forceps



10S
19 cm
0120-10S
upper molars



16
16.5 cm
0120-16
lower molars



17
17.5 cm
0120-17
lower molars

EXTRACTING FORCEPS - AMERICAN PATTERN
without serrated tips



18L Harris
18 cm
0120-18L
upper left molars



18R Harris
18 cm
0120-18R
upper right molars



23
17.5 cm
0120-23
lower molars



53R
18.5 cm
0120-53R
upper right molars



53L
18.5 cm
0120-53L
upper left molars



EXTRACTING FORCEPS - AMERICAN PATTERN
without serrated tips



65
19 cm
0120-65
upper incisors and roots



69 Tomes
18.5 cm
0120-69
upper and lower roots



88R Nevius
18.5 cm
0120-88R
upper right molars



88L Nevius
18.5 cm
0120-88L
upper left molars



101 Hull
15.5 cm
0120-101
deciduous teeth



EXTRACTING FORCEPS - AMERICAN PATTERN

without serrated tips



150 Cryer
18 cm
0120-150
upper incisors, premolars, roots



150S Cryer
15.5 cm
0120-150S
upper teeth
(for children)

151 Cryer
18.5 cm
0120-151
lower incisors,
premolars, roots



151S Cryer
15 cm
0120-151S
lower teeth
(for children)

222
18.5 cm
0120-222
lower wisdom teeth

EXTRACTING FORCEPS - AMERICAN PATTERN - ASALADY

without serrated tips



5 Physick
16.5 cm
W0121-5
lower wisdom teeth



6
16.5 cm
W0121-6
separating forceps

10S
18 cm
W0121-10S
upper molars



16
16 cm
W0121-16
lower molars

17
16.5 cm
W0121-17
lower molars

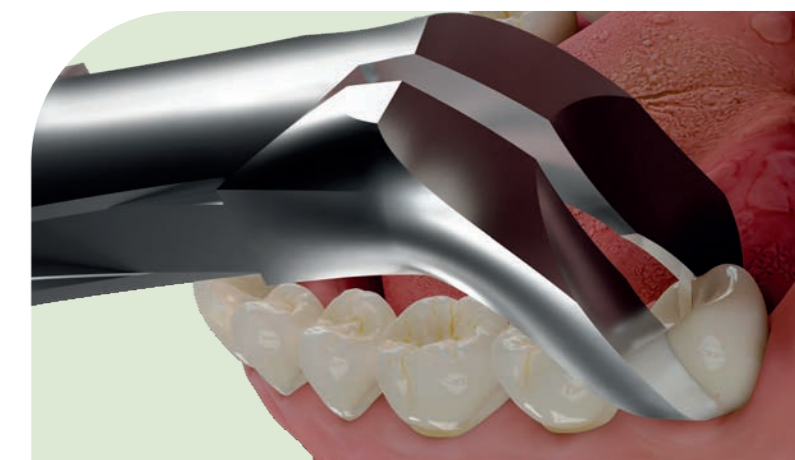

W0121-5

EXTRACTING FORCEPS - AMERICAN PATTERN - ASALADY
without serrated tips



18L Harris
16 cm
W0121-18L
upper left molars



AsaLady



18R Harris
16 cm
W0121-18R
upper right molars



AsaLady



23
16 cm
W0121-23
lower molars



AsaLady



53R
17 cm
W0121-53R
upper right molars



AsaLady



53L
17 cm
W0121-53L
upper left molars



AsaLady

EXTRACTING FORCEPS - AMERICAN PATTERN - ASALADY
without serrated tips



65
18 cm
W0121-65
upper incisors and roots



AsaLady



69 Tomes
17 cm
W0121-69
upper and lower roots



AsaLady



88R Nevius
17.5 cm
W0121-88R
upper right molars



AsaLady



88L Nevius
17.5 cm
W0121-88L
upper left molars



AsaLady



101 Hull
16 cm
W0121-101
deciduous teeth



AsaLady

EXTRACTING FORCEPS - AMERICAN PATTERN - ASALADY

without serrated tips



150 Cryer
16.5 cm
W0121-150
upper incisors, premolars, roots



150S Cryer
16 cm
W0121-150S
upper teeth
(for children)

151 Cryer
16.5 cm
W0121-151
lower incisors,
premolars, roots



151S Cryer
16.5 cm
W0121-151S
lower teeth
(for children)

222
17 cm
W0121-222
lower wisdom teeth

EXTRACTING FORCEPS - ANATOMICALLY SHAPED HANDLE

serrated tips



1
17 cm
0130-1
upper incisors and canines



2
17 cm
0130-2
upper incisors and canines

4
15.5 cm
0130-4
lower incisors and canines



7
17 cm
0130-7
upper premolars

13
14.5 cm
0130-13
lower premolars

EXTRACTING FORCEPS - ANATOMICALLY SHAPED HANDLE

serrated tips

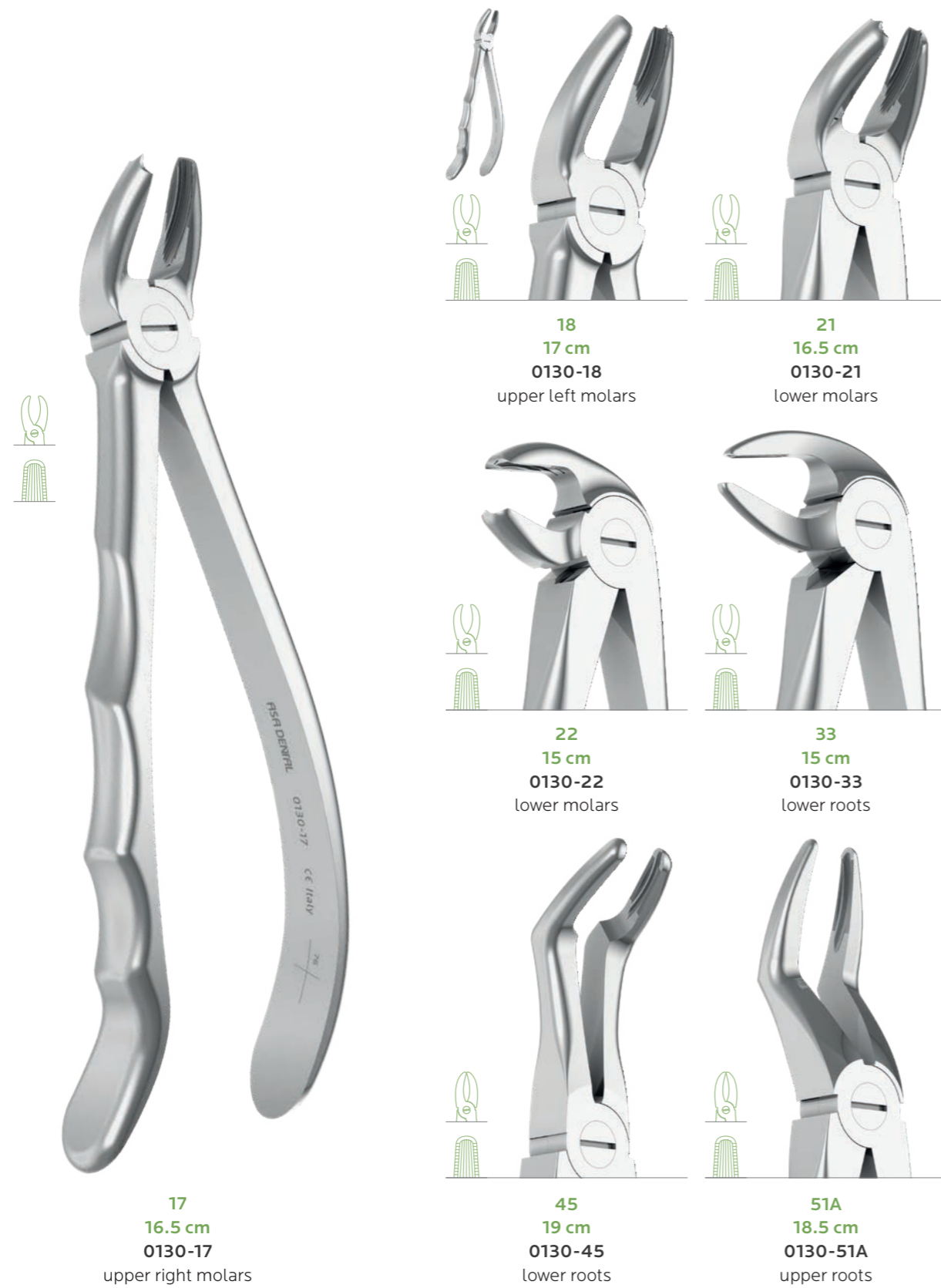

EXTRACTING FORCEPS - ANATOMICALLY SHAPED HANDLE

serrated tips



EXTRACTING FORCEPS - ANATOMICALLY SHAPED HANDLE

serrated tips



89
17.5 cm
0130-89
upper right molars



90
17.5 cm
0130-90
upper left molars

145
19 cm
0130-145
lower roots



151 1/2
19.5 cm
0130-151/
upper roots

349
19 cm
0130-349
upper roots



359
15.5 cm
0130-359
lower roots

EXTRACTING FORCEPS FOR CHILDREN

serrated tips



13S
14.5 cm
0110-13S
lower premolars



22S
14 cm
0110-22S
lower molars

30S
16 cm
0110-30S
upper incisors and roots

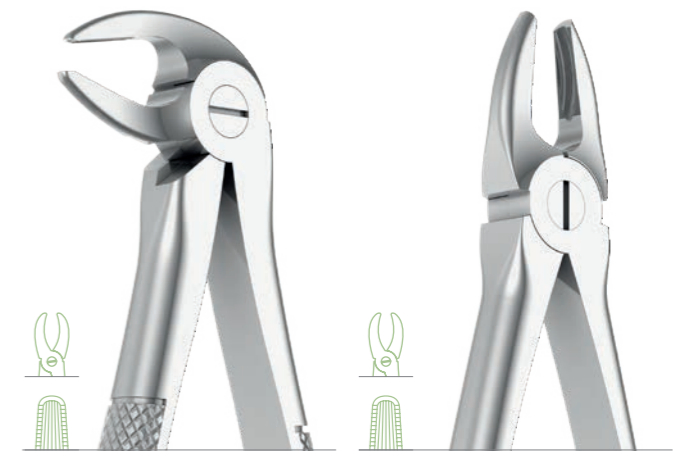

33S
14 cm
0110-33S
lower roots

37
15 cm
0110-37
upper incisors and roots

EXTRACTING FORCEPS FOR CHILDREN

serrated tips



S0110

0110-37	37
0110-39	39
0110-39R	39R
0110-39L	39L
0110-51S	51S
0110-13S	13S
0110-30S	30S
0110-33S	33S
0110-22S	22S
0110-38	38



38
14 cm
0110-38
lower incisors and canines



39
16 cm
0110-39
upper molars

39R
16 cm
0110-39R
upper right molars

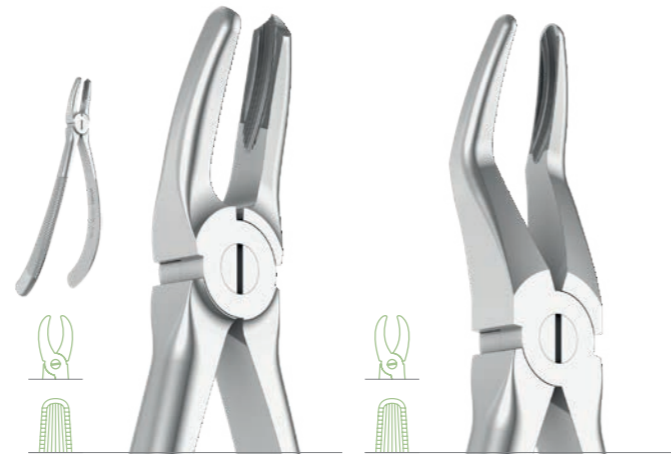

39L
16 cm
0110-39L
upper left molars

51S
17 cm
0110-51S
upper roots

EXTRACTING FORCEPS FOR CHILDREN - KLEIN PATTERN

serrated tips



S0112

0112-1	1
0112-2	2
0112-3	3
0112-4	4
0112-5	5
0112-6	6
0112-7	7



2
12.5 cm
0112-2
upper premolars

3
13 cm
0112-3
upper molars

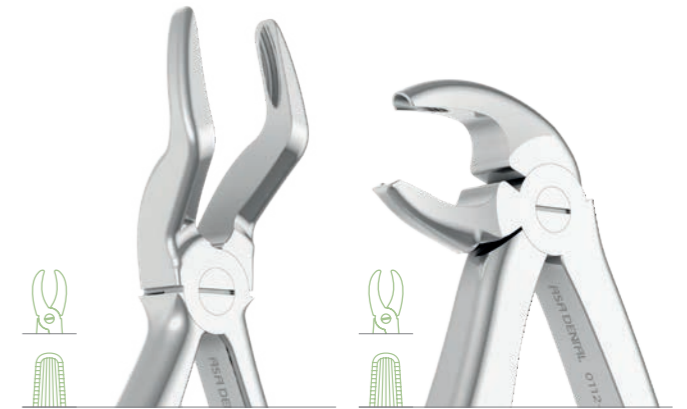

4
13 cm
0112-4
upper roots

5
13 cm
0112-5
lower incisors



1
12 cm
0112-1
upper incisors



6
12.5 cm
0112-6
lower molars

7
13 cm
0112-7
lower roots

EXTRACTING FORCEPS FOR ROOTS

serrated tips

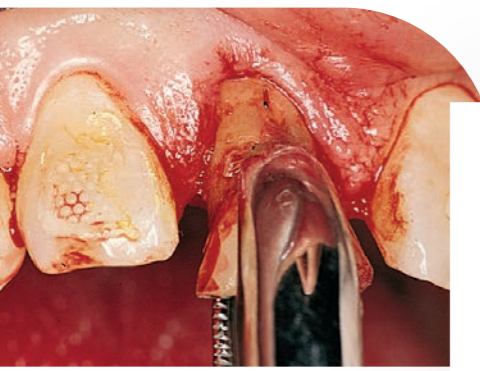

0101-1

Witzel extracting forceps are extremely versatile instruments that can be used to extract both teeth and roots.

The serrated rims, curved shape and slim profile make them effective on roots, preventing unwanted fractures.



1 Witzel
16.5 cm
0101-1
lower roots



2 Witzel
16 cm
0101-2
upper roots

ROOT AND SPLINTER FORCEPS

without serrated tips



0102-1

These forceps are designed to amplify hand sensitivity and guarantee precision.

The scissor-like handle increases guidance while the narrow beaks make it possible to reach and firmly grip even small, deep root fragments.



1 Stieglitz
14.5 cm
0102-1
root fragments



2 Stieglitz
14 cm
0102-2
root fragments

BONE RONGEURS

BONE RONGEURS



Luer
15 cm
0103-10



Friedman
14.5 cm
0103-20



Mini Friedman
12 cm
0103-25



Cleveland 5
16.5 cm
0103-40



Cleveland-Gardner
16.5 cm
0103-45



Blumenthal
15 cm
0103-30



Blumenthal
13.5 cm
0103-31



Blumenthal
14 cm
0103-32



Mead 1A
16.5 cm
0103-50

BONE RONGEURS
multiple action



Mini-Ruskin
15.5 cm
0103-70



Beyer
18 cm
0103-71

BONE/SOFT TISSUE NIPPER
small size for use in limited access areas



Goldman-Fox
10 cm
0103-60

ROOT ELEVATORS WITH A STAINLESS STEEL HANDLE

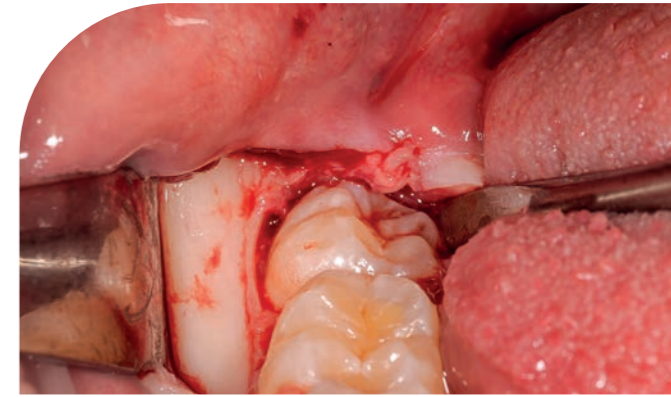

0234-1



1 Hylin
0234-1



2 Hylin
0234-2



3 Hylin
0234-3



4 Hylin
0234-4

ATRAUMATIC LUXATORS - IDEAL
 periostomes for atraumatic extraction



2
0280-2R
 straight, 2 mm

3
0280-3R
 straight, 3 mm

3
0280-3C
 curved, 3 mm

5
0280-5R
 straight, 5 mm

ATRAUMATIC LUXATORS - IDEAL
 double-blade periostomes for atraumatic extraction



5
0280-5C
 curved, 5 mm

3
0280-3DF
 3 mm

5
0280-5DF
 5 mm

ROOT LEVER SET
 with a plastic handle



S0280-4
 includes:
 0280-3R
 0280-3C
 0280-5R
 0280-5C

ROOT ELEVATORS WITH A STAINLESS STEEL HANDLE



0231-2



ROOT ELEVATORS WITH A STAINLESS STEEL HANDLE



S0200-6

0200-1	1B
0200-4	4B
0201-2	2F
0201-3	3F
0220-44	44
0220-45	45



ROOT ELEVATORS WITH A STAINLESS STEEL HANDLE



ROOT ELEVATORS WITH A STAINLESS STEEL HANDLE



0200-2	2B
0200-3	3B
0200-4	4B
0201-2	2F
0201-3	3F
0291-1	1
0291-2	2
0291-3	3
0202-320	320
0202-321	321

ROOT ELEVATORS WITH A STAINLESS STEEL HANDLE
with helicoidal tips



S0244-6

0244-1	1K
0244-2	2K
0244-3	3K
0244-4	4K
0244-5	5K
0244-6	6K



1K Kopp
0244-1



2K Kopp
0244-2



3K Kopp
0244-3



4K Kopp
0244-4



5K Kopp
0244-5



6K Kopp
0244-6

ROOT ELEVATORS WITH A STAINLESS STEEL HANDLE
with helicoidal tips



1
0218-1



2
0218-2



3
0218-3



1
0219-1



2
0219-2



4
0218-4

ROOT ELEVATORS WITH A STAINLESS STEEL HANDLE

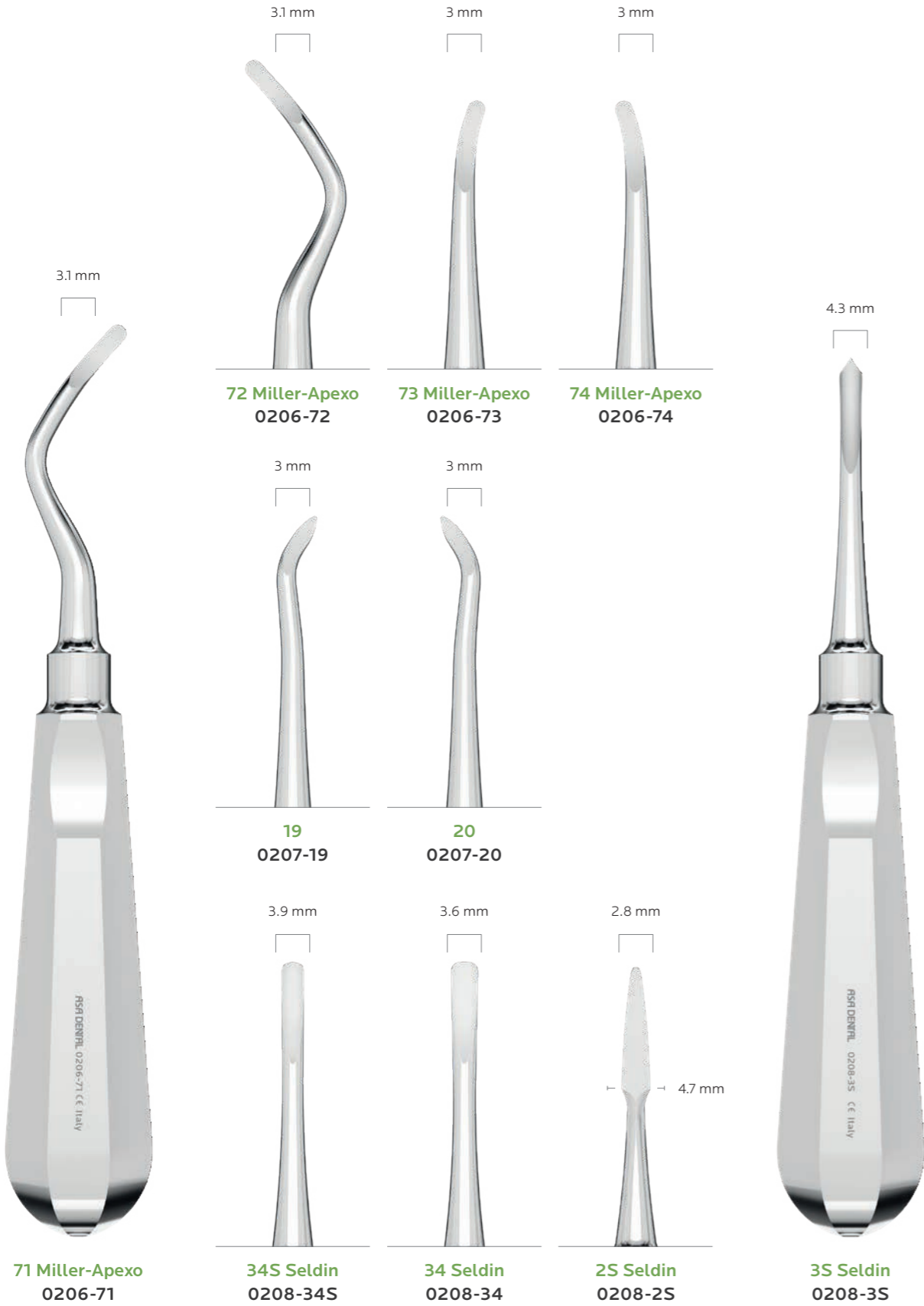

ROOT ELEVATORS WITH A STAINLESS STEEL HANDLE

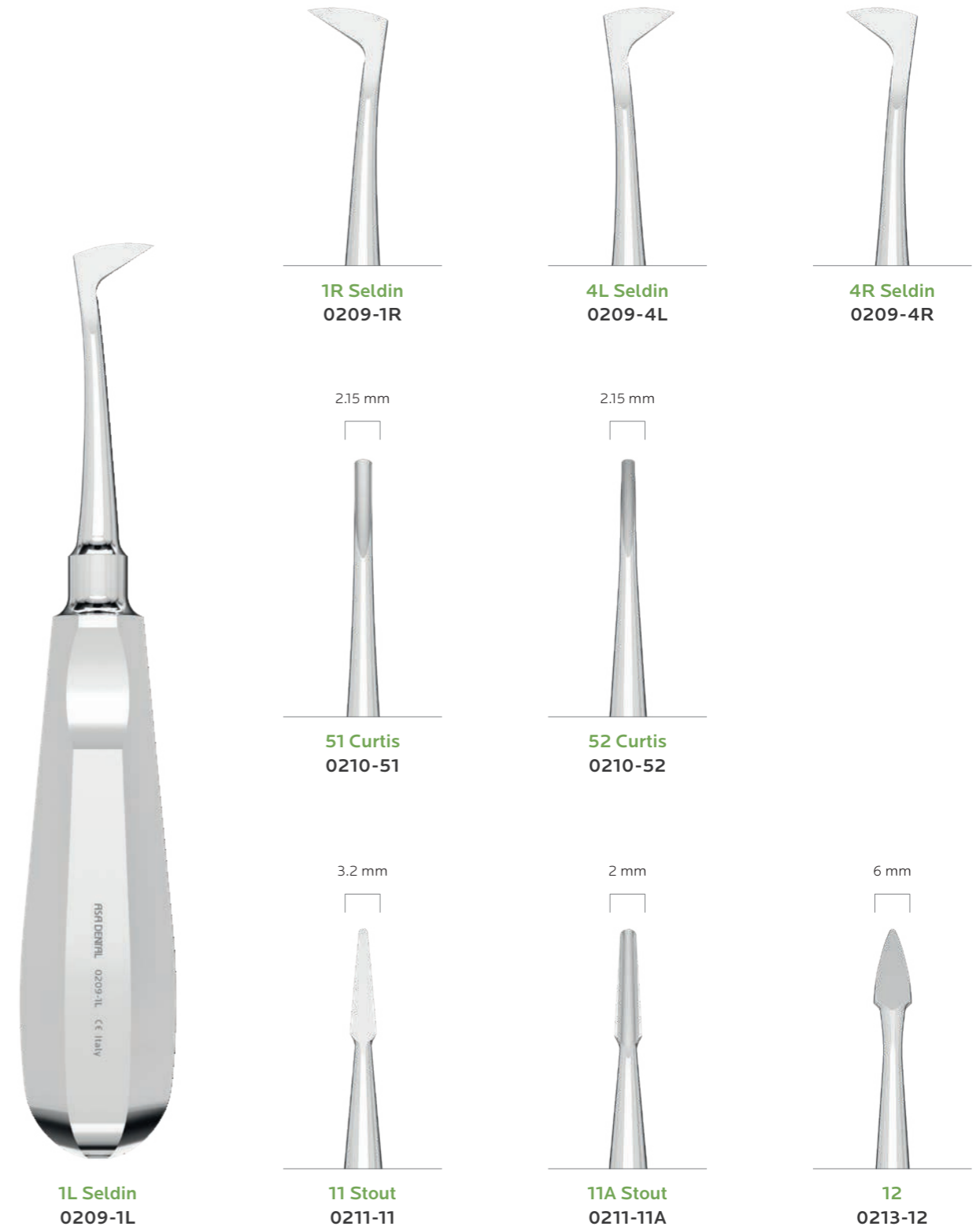

ROOT ELEVATORS WITH A STAINLESS STEEL HANDLE

ROOT ELEVATORS WITH A STAINLESS STEEL HANDLE

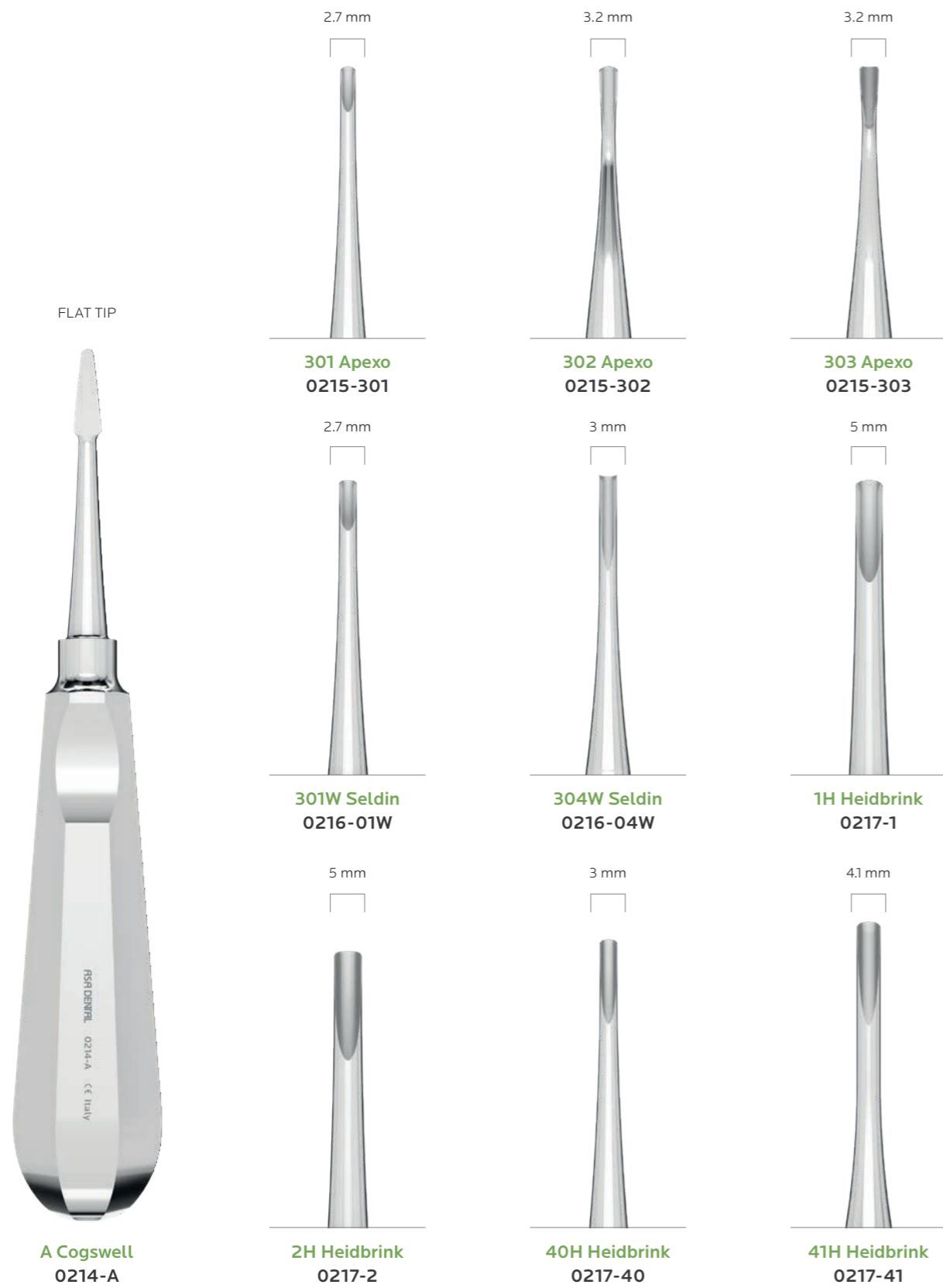

ROOT ELEVATORS WITH A STAINLESS STEEL HANDLE



ROOT ELEVATORS WITH A STAINLESS STEEL HANDLE

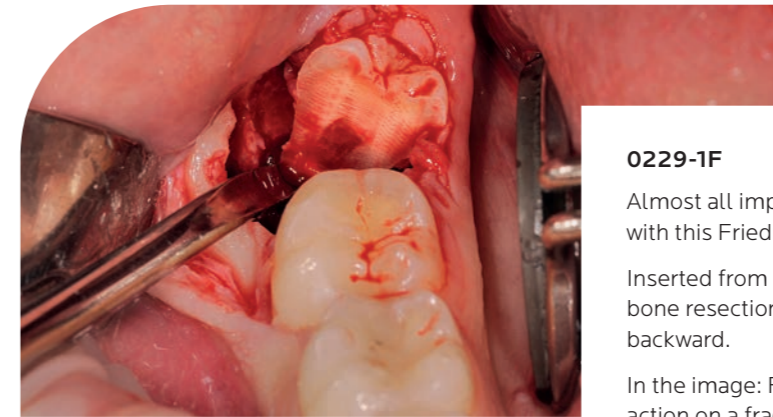

0229-1F
Almost all impacted wisdom teeth can be handled with this Friedman elevator.
Inserted from above into the gap produced by bone resection, it dislocates the tooth upward and backward.
In the image: Friedman elevator and mirror in action on a fragment of third molar (double mirror + Friedman elevator).



ROOT ELEVATORS WITH A STAINLESS STEEL HANDLE

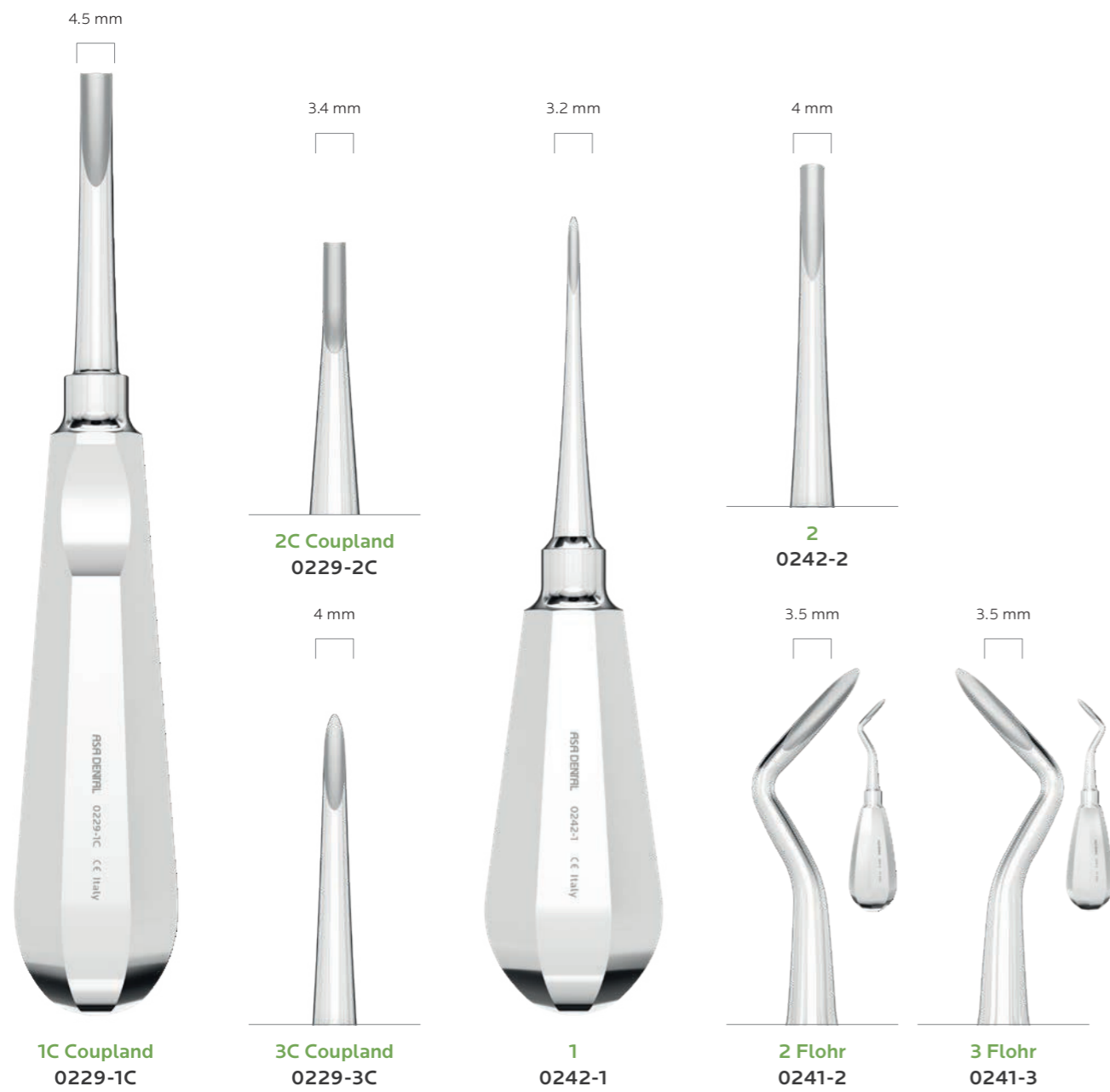

ROOT ELEVATORS WITH A STAINLESS STEEL ERGONOMIC HANDLE



ROOT ELEVATORS WITH A STAINLESS STEEL ERGONOMIC HANDLE



ROOT ELEVATORS WITH A STAINLESS STEEL HANDLE



ROOT ELEVATORS WITH A STAINLESS STEEL HANDLE

ROOT ELEVATORS WITH A STAINLESS STEEL HANDLE

ROOT-TIP PICKS WITH STAINLESS STEEL HANDLE



ROOT-TIP PICKS WITH STAINLESS STEEL HANDLE

SYNDESMOTOMES WITH A STAINLESS STEEL HANDLE



1 Heidbrink
0290-1



2 Heidbrink
0290-2



3 Heidbrink
0290-3



1 Warwick-James
0294-1



2 Warwick-James
0294-2



3 Warwick-James
0294-3



1 Chompret
0295-1



2 Chompret
0295-2



4 Chompret
0295-4



3 Chompret
0295-3



3 Chompret
W0298-3

AsaLady

SYNDESMOTOMES

SYNDESMOTOMES



11 cm
0296-M



0 0296-0
1 0296-1
2 0296-2
3 0296-3
4 0296-4
5 0296-5
6 0296-6
7 0296-7
8 0296-8
9 0296-9
11 0296-11
21 0296-21

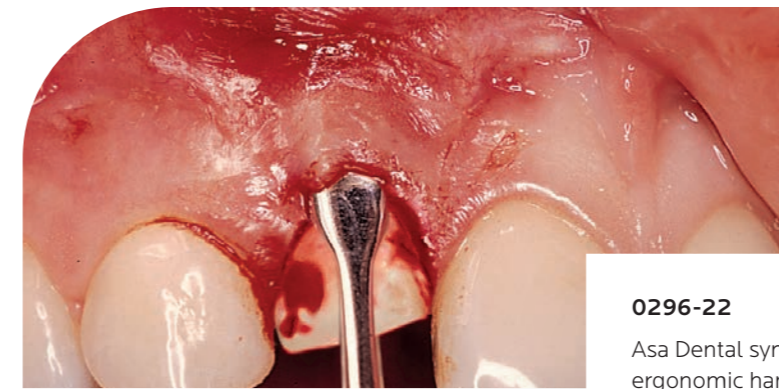

0296-22
Asa Dental syndesmotomes offer the advantage of an ergonomic handle and many easy-to-swap tips, helping solve the clinical case at hand.
They are generally very effective in preparing the field for atraumatic extraction, and many of them can be conveniently used as periostomes.



22 0296-22
23 0296-23
24 0296-24
25 0296-25
26 0296-26
27 0296-27
28 0296-28
29 0296-29

EXCISER



PR1857-1
Perfection

PERIOTOMES



1 ML1845-1 **2** ML1845-2 **3** ML1845-3



PR1857-1
Used immediately following scalpel incision, it facilitates incision of the periosteal up to the exposure of bone tissue.

INSTRUMENT KIT FOR SYNDESMOTOMES

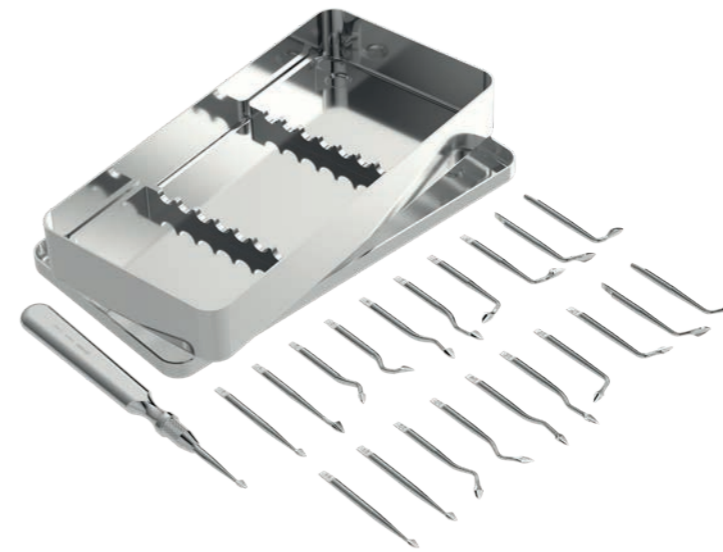

S0296

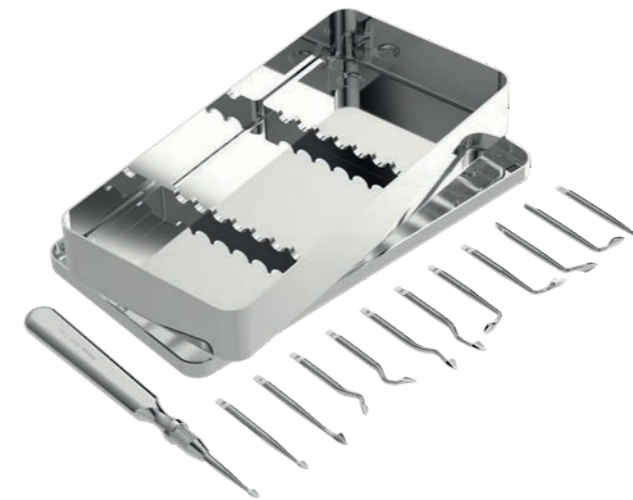

S0296-1



0297-1
Syndesmotome tips holder
20 holes
70x40x12 mm

0296-M	syndesmotome handle	
0296-0	syndesmotome tip	0
0296-1	syndesmotome tip	1
0296-2	syndesmotome tip	2
0296-3	syndesmotome tip	3
0296-4	syndesmotome tip	4
0296-5	syndesmotome tip	5
0296-6	syndesmotome tip	6
0296-7	syndesmotome tip	7
0296-8	syndesmotome tip	8
0296-9	syndesmotome tip	9
0296-11	syndesmotome tip	11
0296-21	syndesmotome tip	21
0296-22	syndesmotome tip	22
0296-23	syndesmotome tip	23
0296-24	syndesmotome tip	24
0296-25	syndesmotome tip	25
0296-26	syndesmotome tip	26
0296-27	syndesmotome tip	27
0296-28	syndesmotome tip	28
0296-29	syndesmotome tip	29
S2700	instrument tray complete with insert frame	

0296-M	syndesmotome handle	
0296-0	syndesmotome tip	0
0296-1	syndesmotome tip	1
0296-2	syndesmotome tip	2
0296-3	syndesmotome tip	3
0296-4	syndesmotome tip	4
0296-5	syndesmotome tip	5
0296-6	syndesmotome tip	6
0296-7	syndesmotome tip	7
0296-8	syndesmotome tip	8
0296-9	syndesmotome tip	9
0296-11	syndesmotome tip	11
S2700	instrument tray complete with insert frame	



KIT FOR EXTRACTION AND ORAL SURGERY



Oral surgery kit
SPR2781-S

ML2101	mouth mirror handle	
2230-5	double sided mouth mirrors	5
0702L-15	periodontal pocket probes	CP-15
0350-5	scalpel handle and blade	5
PR1857-1	exciser	
MV1851-PR3	Prichard periosteal	PR3
PR0625-2	tissue pliers	
1855-23	Seldin retractor	23
2616-1	Farabeuf retractor	
0229-2F	Friedman root elevator	
0229-1F	Friedman root elevator	
0291-1F	Mini Friedman root elevator	
0291-2F	Mini Friedman root elevator	
ML2001-85	Lucas bone curette	85
ML2001-87	Lucas bone curette	87
ML2001-88	Lucas bone curette	88
ML1806-2RL	periodontal instrument	2R/2L
ML1806-4RL	periodontal instrument	4R/4L
PR0460-15TC	Castroviejo needle holder	
0309-2TC	gum scissors	2TC
2780-1B	instrument cassette	



S0100-3

0100-33	extracting forceps	33
0100-51A	extracting forceps	51A
0100-67A	extracting forceps	67A
0100-79	extracting forceps	79
0200-1	root elevator	1B
0201-2	root elevator	2F
0201-3	root elevator	3F
0202-320	root elevator	320
0202-321	root elevator	321



S0100-4

0100-33	extracting forceps	33
0100-51A	extracting forceps	51A
0100-67A	extracting forceps	67A
0100-79	extracting forceps	79
0200-1	root elevator	1B
0201-2	root elevator	2B
0201-3	root elevator	3B
0435-14TC	needle holders	
0425-16TC	needle holders	

ACCESSORIES

case for instruments and pliers



9002

1	9002	case
2	9002-2	insert with elastic bands for 10 instruments
3	9002-3	insert with slots for 16 instruments
4	9002-1	insert for 6 extractive forceps

AUTOClave INSTRUMENT PROTECTION LUBRICANT

Maximum protection of instruments in the autoclave. Penetrates and lubricates all instrument joints. Protects all dental and surgical instruments before and after sterilization. Instructions for use: oil all instrument tips, joints and fastenings before and after sterilization.

Special lubricant for dental and surgical instruments. Lubricates the joints of scissors, hemostatic and extracting forceps, bone rongeurs, needle holders etc., before and after sterilization. Does not dry out during sterilization. Provides protection from corrosion and other deposits and ensures proper operation of the instruments.



Steril Oil
40 ml
8002



Silicone
40 ml
8010

IMPLANT SURGERY

MADE IN ITALY



E4	Scissors
E5	Needle holders
E7	Scalpels
E10	Retractors
E13	Sinus lift instruments
E16	Surgical mallets
E16	Surgical chisels
E18	Osteotomes
E21	Bone instruments and accessories
E32	Pocket probes
E32	Depth gauges
E33	Saliva ejectors
E33	Calipers
E34	Burs
E35	Bone compactors
E35	Pocket markers
E36	Tissue pliers
E37	Tweezers
E38	Kits

RECOVERY OF TOOTH FRAGMENTS THROUGH SURGERY

In the last decade, implantology has become an important part of clinical practice, helping dentists improve the quality of life of their patients. While implants might often be a convenient alternative to conventional treatment options, in certain cases, it is mandatory for the rehabilitation of functional, anatomical or aesthetic problems arising from tooth loss.

Asa Dental has developed a number of highly functional and easy-to-use instruments to help

qualified dentists tackle even the most challenging clinical cases and to effectively and fully deliver all the advantages of implant surgery, including a high degree of stability, the preservation of bone in the alveolar process, and long-term results. Our proficiency with design and manufacturing has led to educational collaboration with major dental institutions to grow competency in this branch among dental professionals.



HANDLE

SINGLE-ENDED

- Asa60**
(stainless steel)
ø 6.0 mm
- Leonardo ML**
(stainless steel)
ø 7.0 mm
- Perfection**
(stainless steel)
ø 8.0 mm
- **AsaWave RC**
(plastic resin in PPSU
with a steel core)
ø 7.5 / 14.5 mm



DOUBLE-ENDED

- Asa60**
(stainless steel)
ø 6.0 mm
- Asa Light MV**
(stainless steel, hollow)
ø 8.0 mm
- Leonardo ML**
(stainless steel)
ø 7.0 mm
- Perfection**
(stainless steel)
ø 8.0 mm
- Octagonal**
(stainless steel)
ø 5.5 mm
- **AsaWave RC**
(plastic resin in PPSU
with a steel core)
ø 7.5 / 14.5 mm

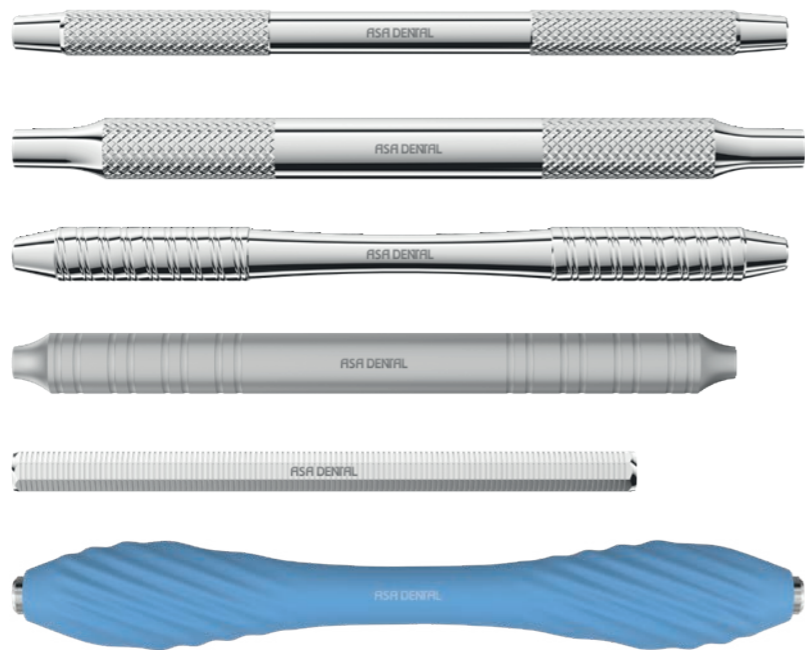

HOW TO USE THE INFORMATION

- CP-12** — model + scientific name
- RC0702-12** — Asa Dental code
- **AsaWave RC** — handle option

AsaLady

products ergonomically designed for women's hands:

- smaller and lighter handles
- smaller finger holes
- reduced size

code starts with "W" or "SW"

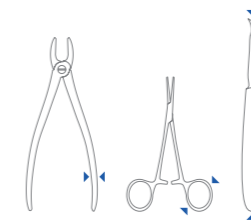

these products are not manufactured by Asa Dental and are distributed with the manufacturer's brand



top view



side view

GUM SCISSORS



1 Goldman-Fox
straight
one serrated blade
13 cm
0304-1



2 Goldman-Fox
curved
one serrated blade
13 cm
0304-2



1TC Kelly
straight
16 cm
0309-1TC



2TC Kelly
curved
16 cm
0309-2TC

Dissecting scissors



1 Metzenbaum-Delikat
straight
14.5 cm
0322-1



2 Metzenbaum-Delikat
curved
14.5 cm
0322-2

NEEDLE HOLDERS



TC Mathieu
14 cm
0435-14TC



TC Mathieu
17 cm
0435-17TC



TC Lichtenberg
17 cm
0437-17TC



TC Castroviejo
14 cm
0445TH-14TC



TC Castroviejo
14 cm
0446TH-14TC



TC Castroviejo
14 cm / 60°
0448TH-14TC

NEEDLE HOLDERS

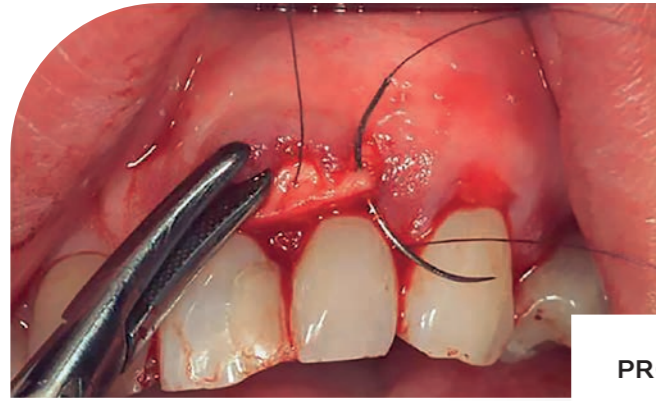

PR0460-15TC
Curved Castroviejo needle holder.
Facilitates suturing.

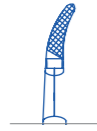

TC Castroviejo
with curved jaws
15.5 cm
PR0460-15TC

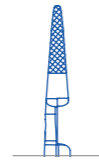

TC Micro-Barraquer
18 cm
0450TH-18TC

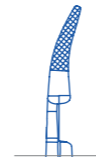

TC Micro-Barraquer
with curved jaws
18 cm
0451TH-18TC

SCALPEL HANDLES



3
13 cm
0350-3



3
12 cm
W0349-3



3G
13 cm
0350-3G



8
13 cm
0350-8



7
16 cm
0350-7

SCALPEL HANDLES

SCALPEL BLADES 
100 pcs (sterile) / box

MICRO-BLADES 
25 pcs (sterile) / box

ORIENTABLE BLADE
SCALPEL HANDLES

BLADE
REMOVER



5
14.5 cm
0350-5



5A
14.5 cm
0350-5A



10
0351-10



11
0351-11



12
0351-12



12D
double
cutting edge
0351-12D



15
0351-15



15C
0351-15C



4
0366-4



7
0366-7

13.5 cm
0365-1



16 cm
0335-1
(pair of instruments)



16.5 cm
0352



S0352
kit of
0352
blade remover +
0335-1
(pair of instruments)
orientable blade scalpel
handles



DISPOSABLE SCALPELS 
10 pcs / box

RETRACTORS
Lip retractor

Openable vestibular retractor

RETRACTORS

Lip retractors

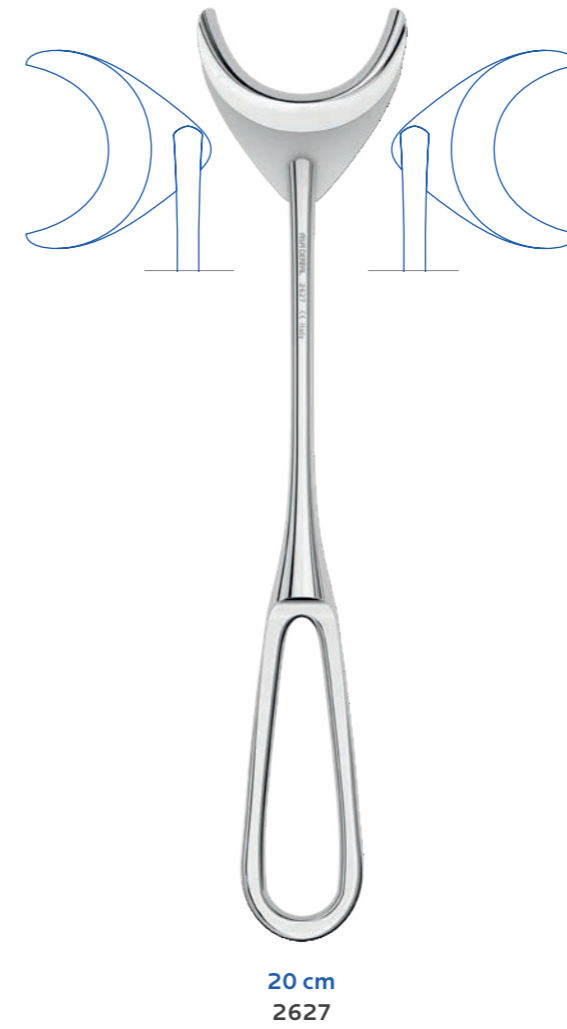
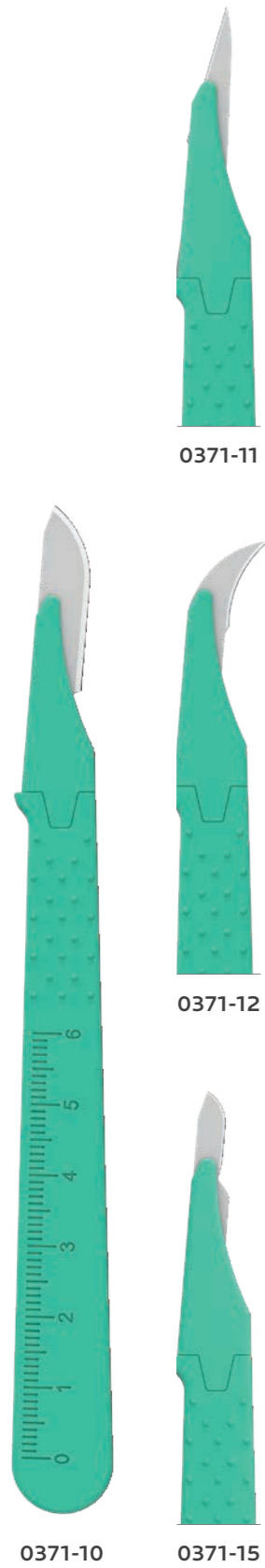

RETRACTORS
Cheek retractor



Nasal spine ramus retractors



SINUS LIFT INSTRUMENTS

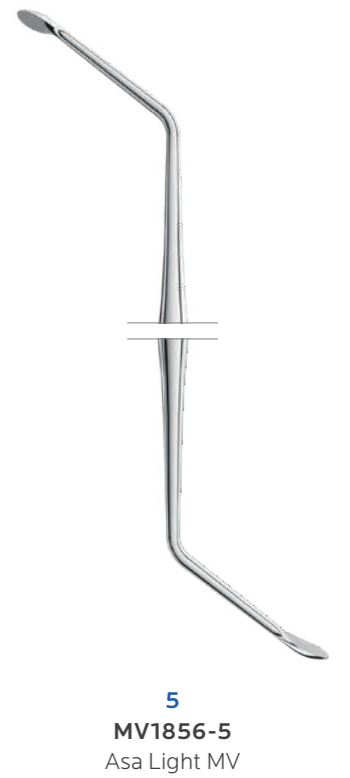
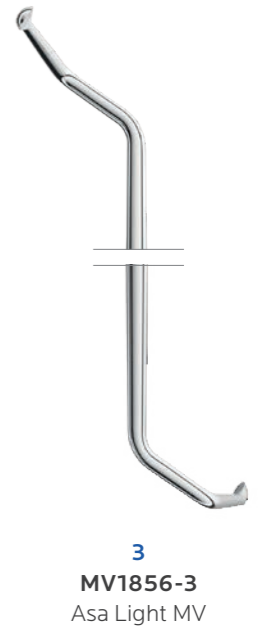
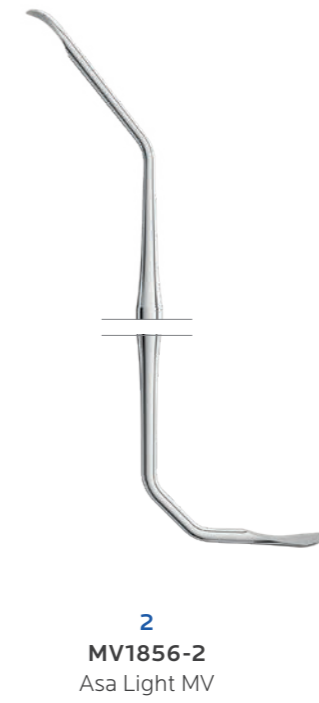

SINUS LIFT INSTRUMENTS

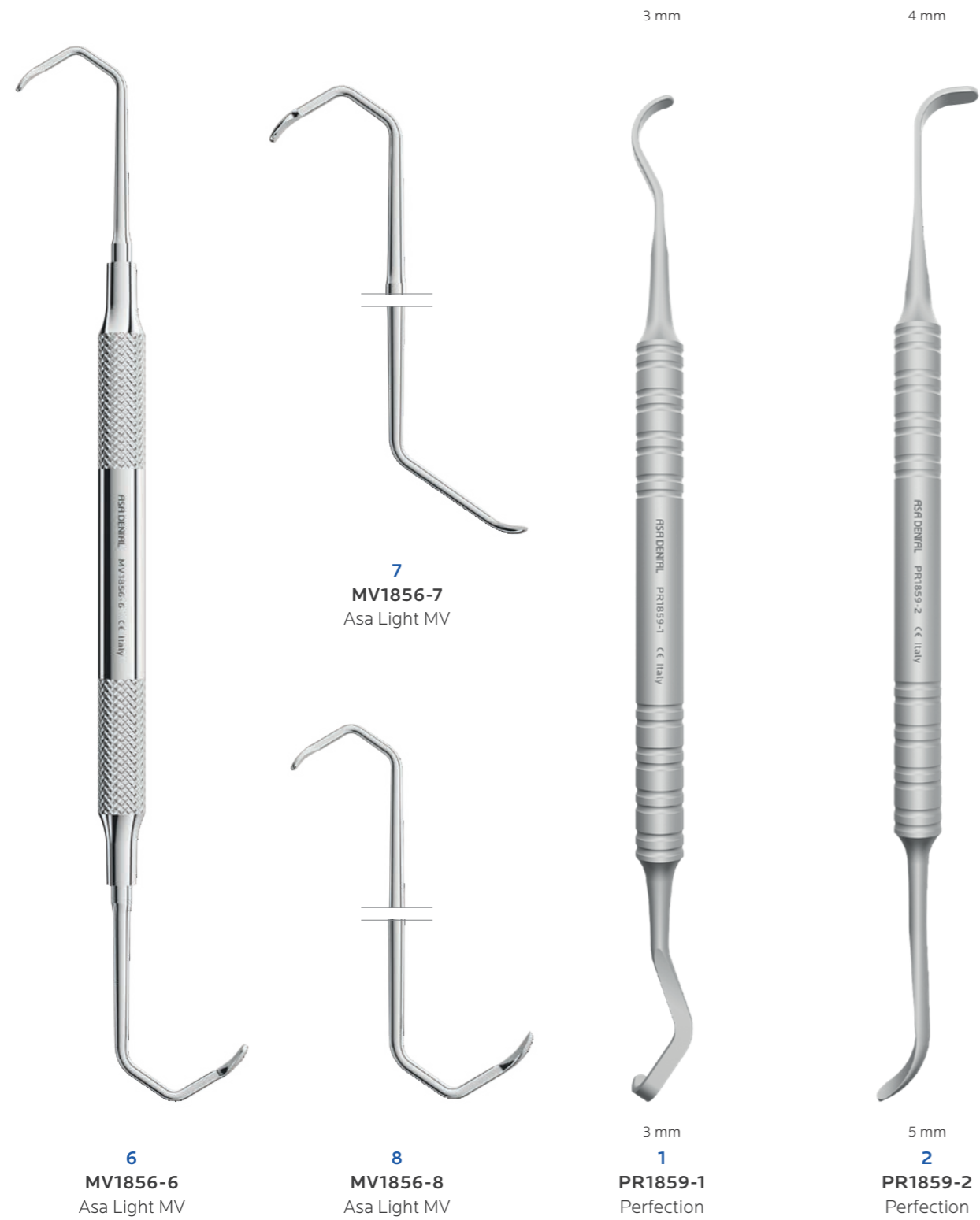

SINUS LIFT INSTRUMENTS

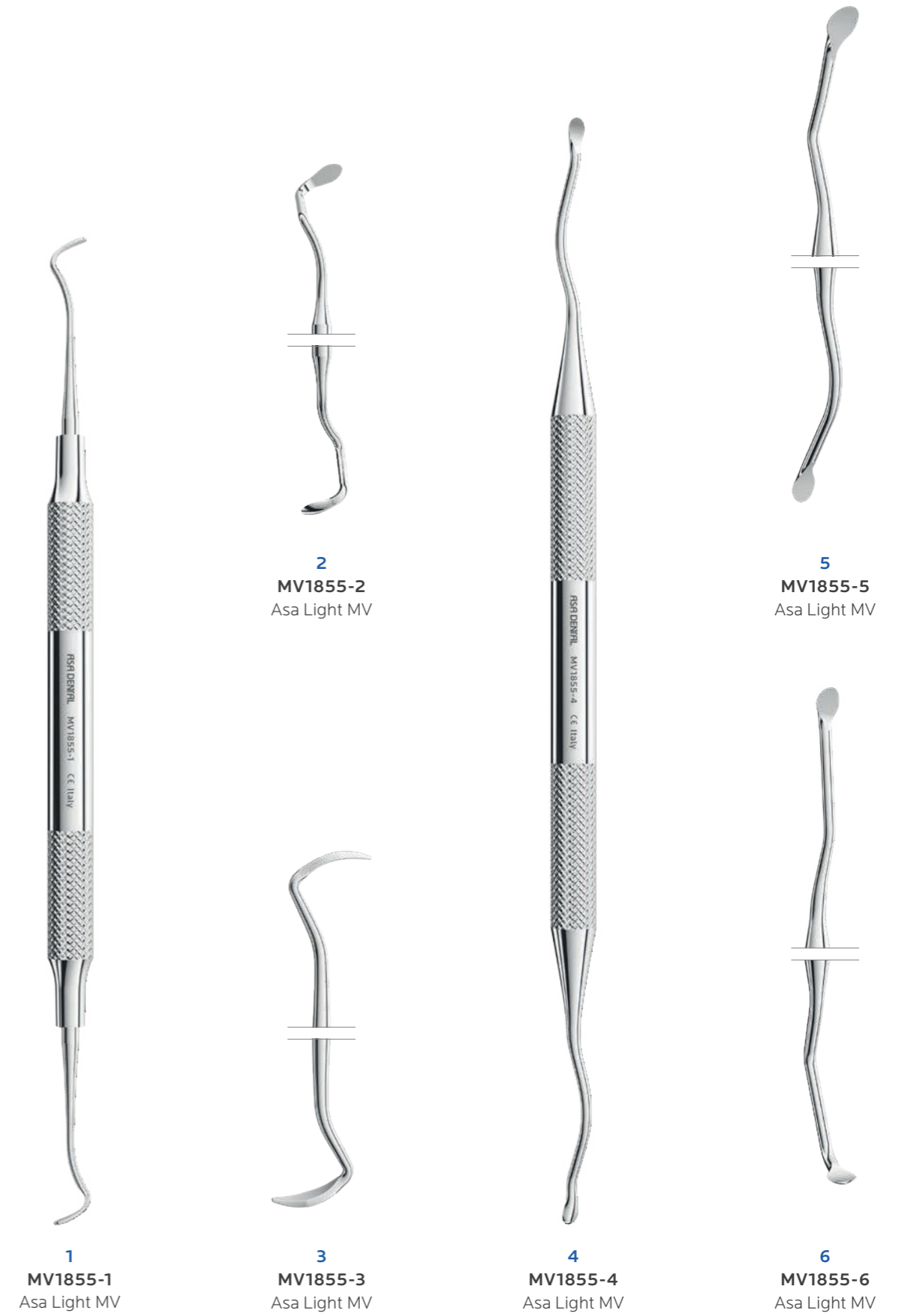

SURGICAL MALLET

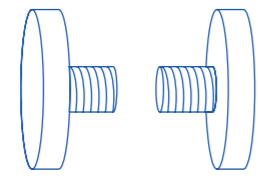

1881-R
2 Teflon spare inserts
autoclavable
max 120°C



Partsch
18 cm
1880
lead filled

Mead
19.5 cm
1881

FREER SINGLE CUT CHISELS



GRADUATED CHISELS

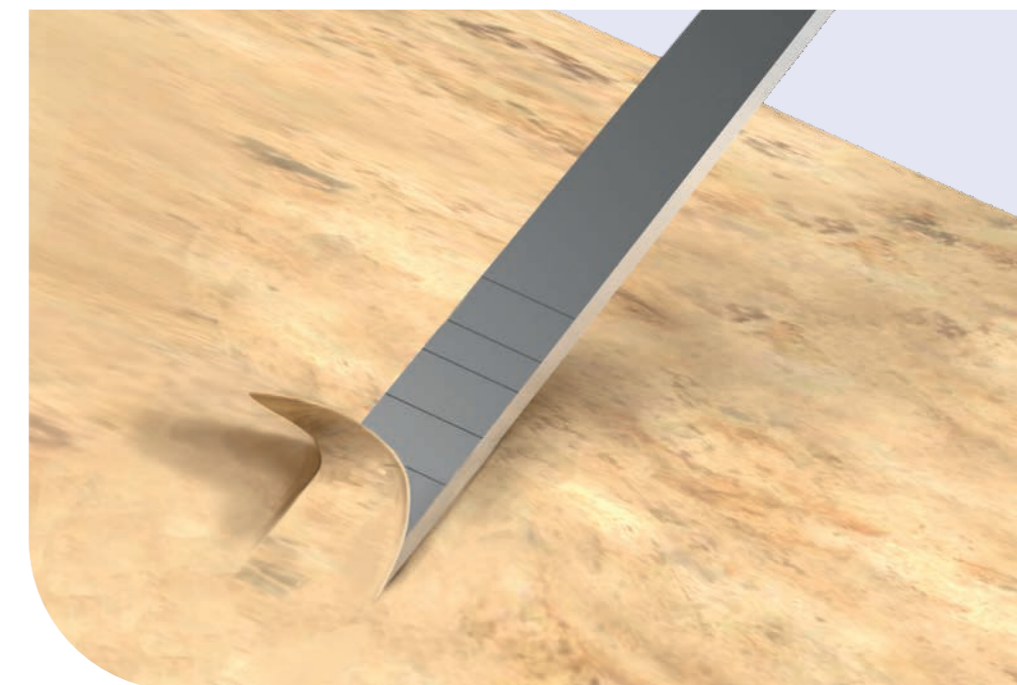
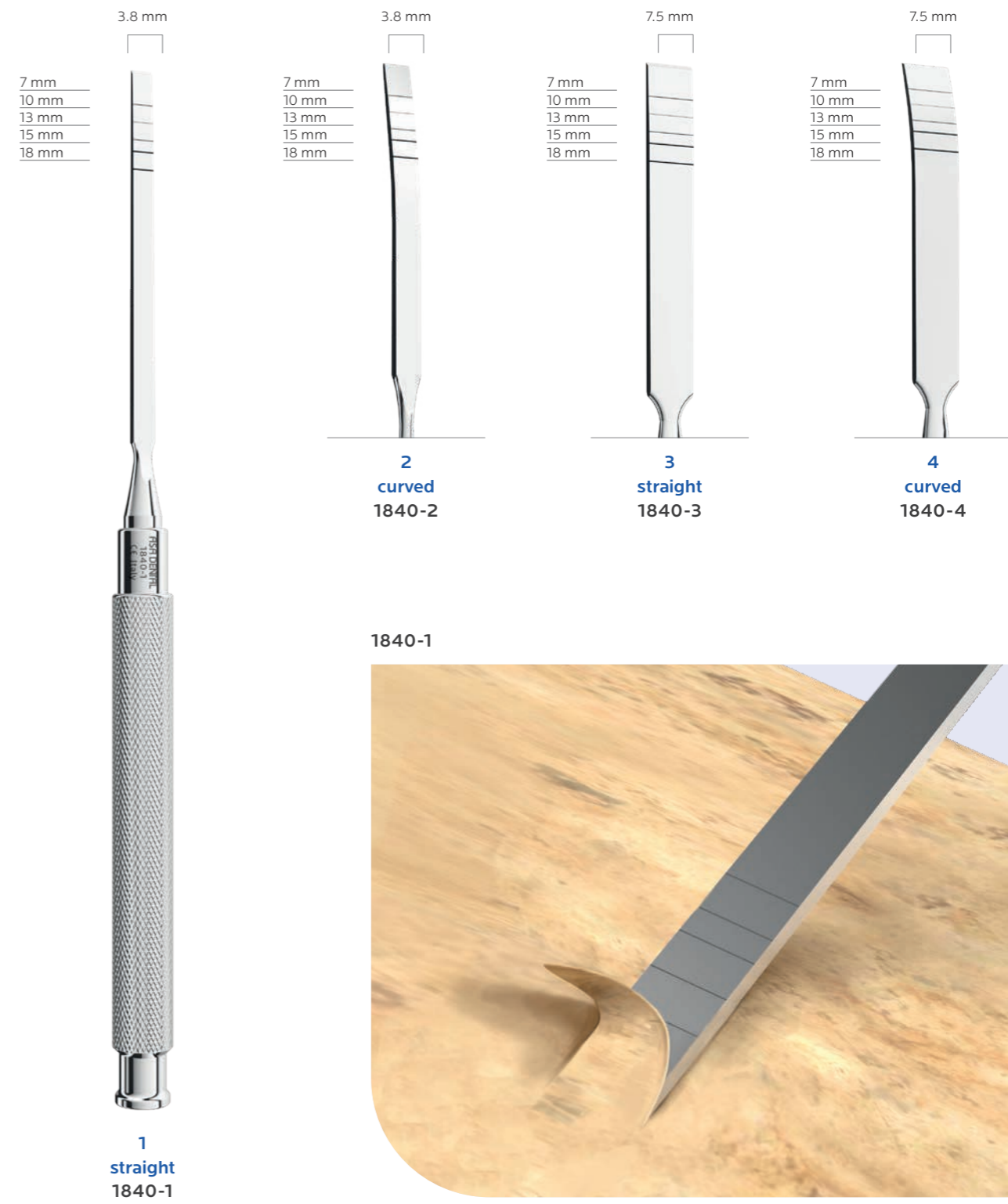

OSTEOTOMES

annular
osteotomes with
setting point

 CONCAVE Ø 3 mm	 CONCAVE Ø 3.3 mm	 CONCAVE Ø 3 mm	 CONCAVE Ø 3.3 mm	 ANGULAR Ø 3 mm	 FLAT Ø 3 mm
 6 mm 8 mm 10 mm 12 mm 15 mm 165 mm 0498-1B3	 165 mm 0498-2C3	 165 mm 0498-30B3	 120 mm 0498-PF3	 Ø 3.3 mm 165 mm 0498-30B3	 Ø 3.3 mm 120 mm 0498-PF3
 Ø 4 mm 165 mm 0498-1B4	 Ø 4 mm 165 mm 0498-2C4	 Ø 4 mm 165 mm 0498-30B4	 Ø 4 mm 120 mm 0498-PF4	 Ø 4 mm 165 mm 0498-30B4	 Ø 4 mm 120 mm 0498-PF4
 Ø 5 mm 165 mm 0498-1B5	 Ø 5 mm 165 mm 0498-2C5	 Ø 5 mm 165 mm 0498-30B5	 Ø 5 mm 120 mm 0498-PF5	 Ø 5 mm 165 mm 0498-30B5	 Ø 5 mm 120 mm 0498-PF5

OSTEOTOMES

1 · 2 · 3 · 4 · 5 · 6
S0495-6
set of 6
with tray
S2702

 CONCAVE Ø 1.5 mm	 CONCAVE Ø 1.8 mm	 CONCAVE Ø 2.9 mm	 CONCAVE Ø 3.1 mm	 CONCAVE Ø 4.1 mm	 CONCAVE Ø 5.5 mm																																																																								
<table border="1"> <thead> <tr> <th>mm</th> <th>Ø in mm</th> </tr> </thead> <tbody> <tr><td>7.5</td><td>1.6</td></tr> <tr><td>9</td><td>1.7</td></tr> <tr><td>10.5</td><td>2.2</td></tr> <tr><td>12</td><td>2.4</td></tr> <tr><td>13.2</td><td>2.5</td></tr> <tr><td>15.2</td><td>3.4</td></tr> </tbody> </table>	mm	Ø in mm	7.5	1.6	9	1.7	10.5	2.2	12	2.4	13.2	2.5	15.2	3.4	<table border="1"> <thead> <tr> <th>mm</th> <th>Ø in mm</th> </tr> </thead> <tbody> <tr><td>7.5</td><td>2</td></tr> <tr><td>9</td><td>2.1</td></tr> <tr><td>10.5</td><td>2.9</td></tr> <tr><td>12</td><td>3</td></tr> <tr><td>13.2</td><td>3.1</td></tr> <tr><td>15.2</td><td>3.2</td></tr> </tbody> </table>	mm	Ø in mm	7.5	2	9	2.1	10.5	2.9	12	3	13.2	3.1	15.2	3.2	<table border="1"> <thead> <tr> <th>mm</th> <th>Ø in mm</th> </tr> </thead> <tbody> <tr><td>7.5</td><td>3.1</td></tr> <tr><td>9</td><td>3.2</td></tr> <tr><td>10.5</td><td>3.3</td></tr> <tr><td>12</td><td>3.4</td></tr> <tr><td>13.2</td><td>3.4</td></tr> <tr><td>15.2</td><td>3.5</td></tr> </tbody> </table>	mm	Ø in mm	7.5	3.1	9	3.2	10.5	3.3	12	3.4	13.2	3.4	15.2	3.5	<table border="1"> <thead> <tr> <th>mm</th> <th>Ø in mm</th> </tr> </thead> <tbody> <tr><td>7.5</td><td>3.8</td></tr> <tr><td>9</td><td>3.9</td></tr> <tr><td>10.5</td><td>4.1</td></tr> <tr><td>12</td><td>4.2</td></tr> <tr><td>13.2</td><td>4.3</td></tr> <tr><td>15.2</td><td>4.6</td></tr> </tbody> </table>	mm	Ø in mm	7.5	3.8	9	3.9	10.5	4.1	12	4.2	13.2	4.3	15.2	4.6	<table border="1"> <thead> <tr> <th>mm</th> <th>Ø in mm</th> </tr> </thead> <tbody> <tr><td>8.5</td><td>5</td></tr> <tr><td>10</td><td>5</td></tr> <tr><td>11</td><td>5</td></tr> </tbody> </table>	mm	Ø in mm	8.5	5	10	5	11	5	<table border="1"> <thead> <tr> <th>mm</th> <th>Ø in mm</th> </tr> </thead> <tbody> <tr><td>8.5</td><td>6.2</td></tr> <tr><td>10</td><td>6.2</td></tr> <tr><td>11</td><td>6.2</td></tr> </tbody> </table>	mm	Ø in mm	8.5	6.2	10	6.2	11	6.2
mm	Ø in mm																																																																												
7.5	1.6																																																																												
9	1.7																																																																												
10.5	2.2																																																																												
12	2.4																																																																												
13.2	2.5																																																																												
15.2	3.4																																																																												
mm	Ø in mm																																																																												
7.5	2																																																																												
9	2.1																																																																												
10.5	2.9																																																																												
12	3																																																																												
13.2	3.1																																																																												
15.2	3.2																																																																												
mm	Ø in mm																																																																												
7.5	3.1																																																																												
9	3.2																																																																												
10.5	3.3																																																																												
12	3.4																																																																												
13.2	3.4																																																																												
15.2	3.5																																																																												
mm	Ø in mm																																																																												
7.5	3.8																																																																												
9	3.9																																																																												
10.5	4.1																																																																												
12	4.2																																																																												
13.2	4.3																																																																												
15.2	4.6																																																																												
mm	Ø in mm																																																																												
8.5	5																																																																												
10	5																																																																												
11	5																																																																												
mm	Ø in mm																																																																												
8.5	6.2																																																																												
10	6.2																																																																												
11	6.2																																																																												
 155 mm 0495-1	 155 mm 0495-2	 155 mm 0495-3	 155 mm 0495-4	 155 mm 0495-5	 155 mm 0495-6																																																																								

OSTEOTOMES

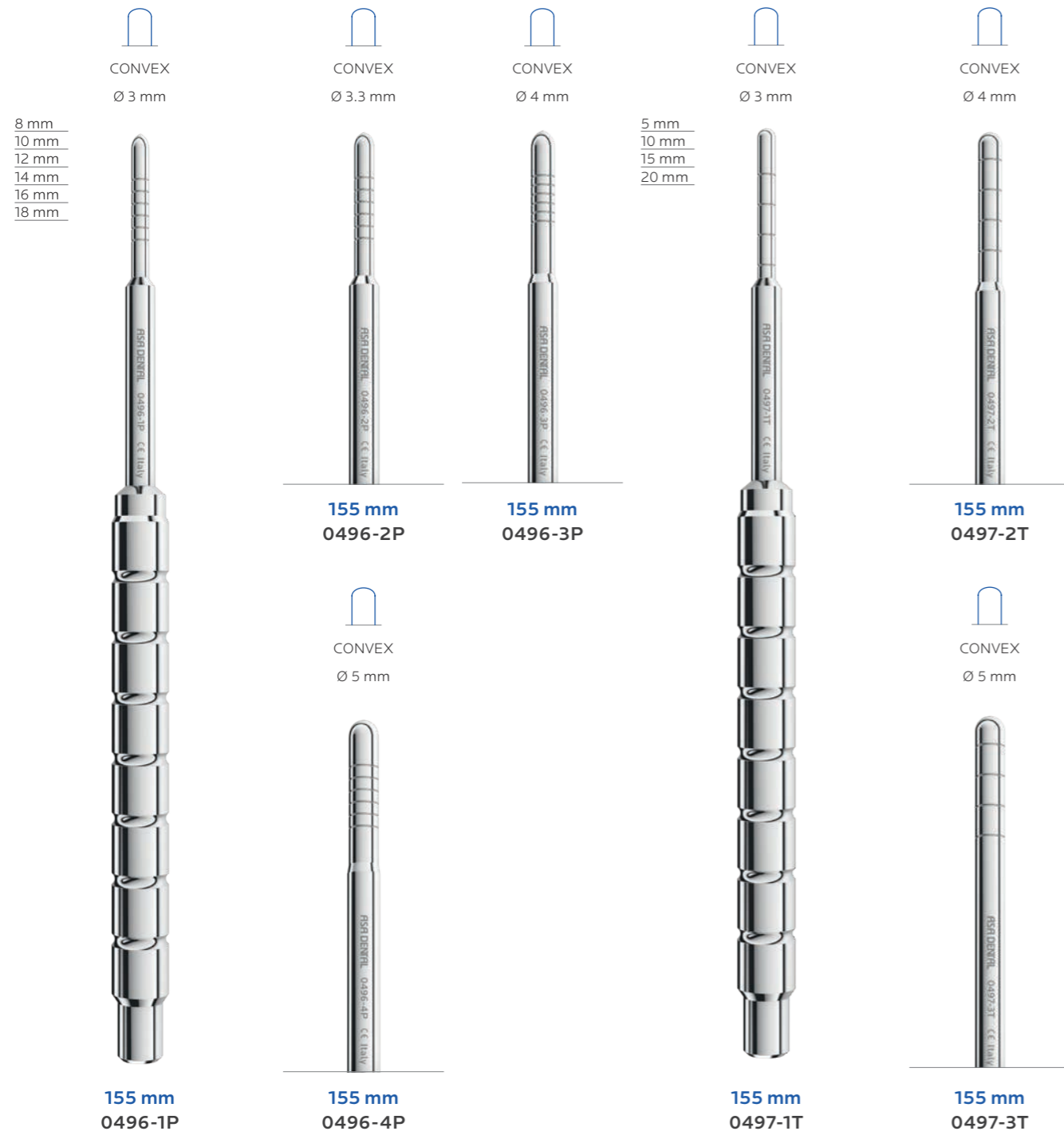

BONE FILES

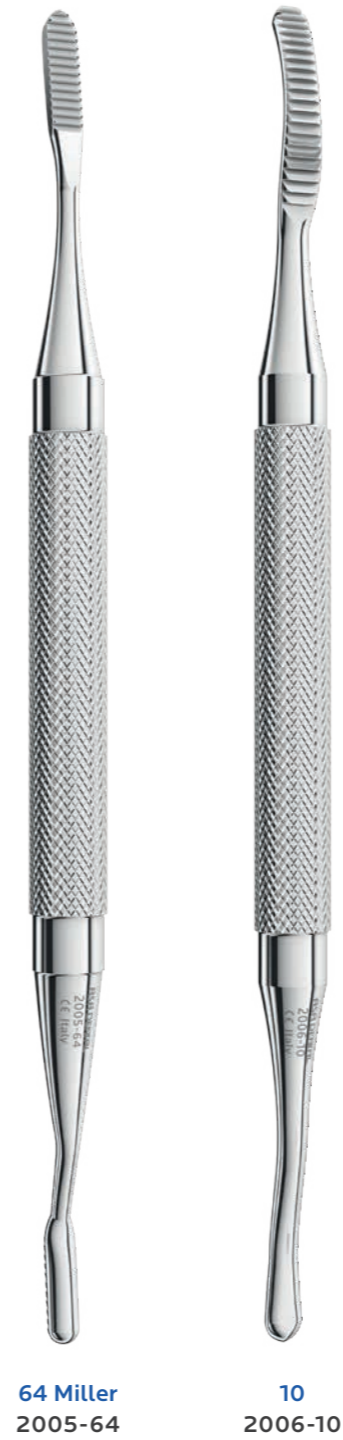

BONE CURETTES

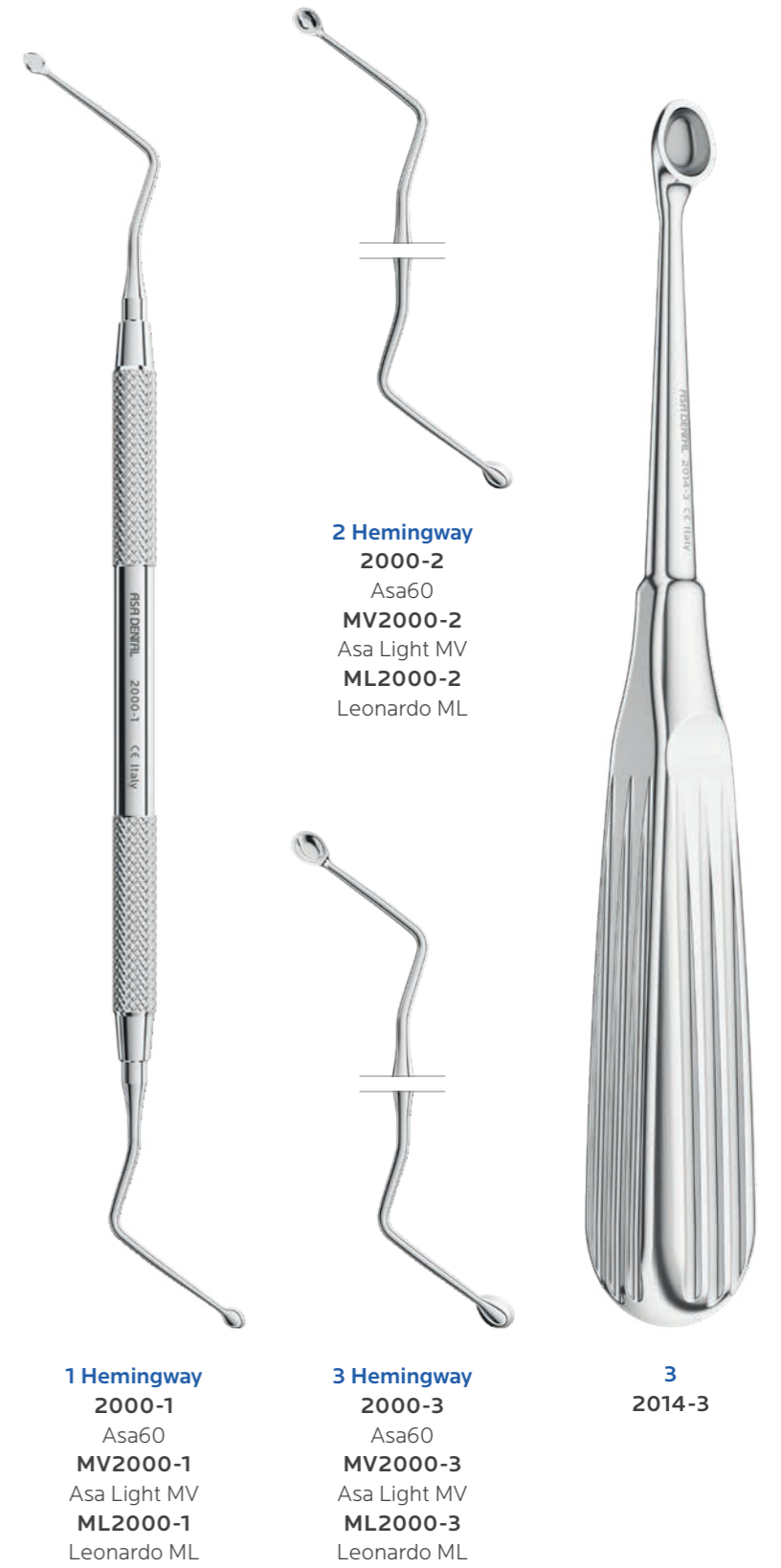

EXCISER



1
PR1857-1
Perfection

PERIOSTEAL ELEVATORS

3 mm
LANCE TIP



3 mm
ROUNDED TIP
Buser
PR1850-M
Perfection



Beale
5114-1
Octagonal



GF Goldman-Fox
MV1850-GF
Asa Light MV

PR1850-M

Periosteal elevator with a rounded tip and a lance tip

Allows efficient release of even the narrowest and scalloped gingival margins.



PERIOSTEAL ELEVATORS



9A Allen
MV1850-9A
Asa Light MV



M7 Molt
MV1850-M7
Asa Light MV



M8 Molt
MV1850-M8
Asa Light MV



M9 Molt
MV1850-M9
Asa Light MV



2 Hourigan
MV1851-2
Asa Light MV



PR3 Prichard
MV1851-PR3
Asa Light MV

PERIOSTEAL ELEVATORS

PR1850-1
PERIOSTEAL ELEVATOR

For atraumatic release and lifting of the papilla in papilla preservation techniques.

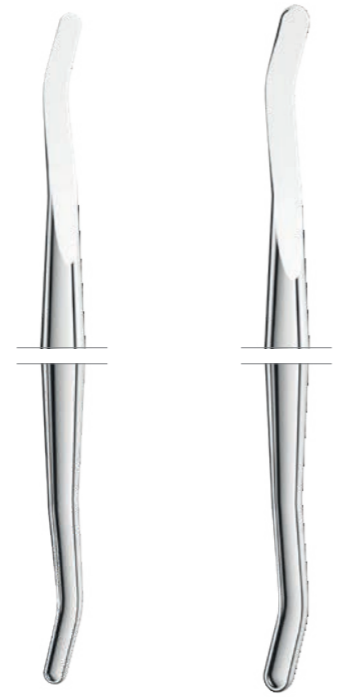

1 Hopkins
MV1852-1
Asa Light MV

2 Hopkins
MV1852-2
Asa Light MV

2 mm



2.5 mm
17 cm
PR1850-1
Perfection



Partsch
14.5 cm
1849-1
Asa60

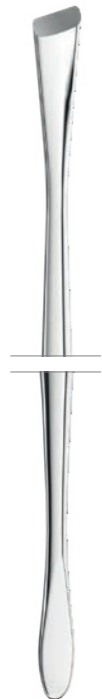

3 Mead
MV1854-3
Asa Light MV



15 Freer
MV1853-15
Asa Light MV



16 Freer
MV1853-16
Asa Light MV

PERIOSTEAL ELEVATORS



22 Seldin
retractor
1855-22



23 Seldin
retractor
1855-23



König
15.5 cm
1858-1



Williger
17 cm
1856-1



Williger
16 cm
1856-2



Williger
16 cm
1857-1



Williger
13 cm
1857-2

MUCOTOMES

3 mm



straight
1844-3

4 mm



straight
1844-4

5 mm



straight
1844-5

6 mm



straight
1844-6

3 mm



curved
1844-3C

4 mm



curved
1844-4C

5 mm



curved
1844-5C

6 mm



curved
1844-6C

BONE INJECTOR

Ø 2.5 mm



16 cm
0490-1

Ø 4.5 mm



16 cm
0490-2

BONE MILL



17 cm
1846

BONE SCRAPERS



straight
15 cm
0494-1
blade included



straight
0494-1R
blade for
0494-1



curved
15 cm
0494-2
blade included



straight
0494-2R
blade for
0494-2

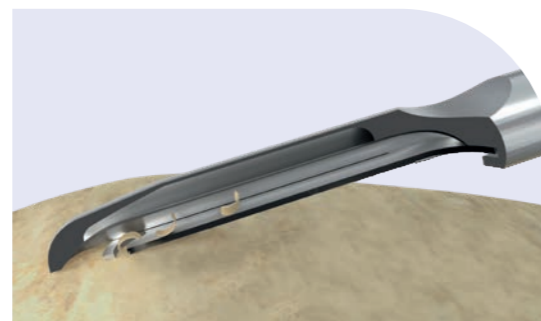

0494-1

PERIOTOMES



1
ML1845-1
Leonardo ML



2
ML1845-2
Leonardo ML



3
ML1845-3
Leonardo ML

BONE
APPLICATOR



MV1231-1
Asa Light MV

BONE/SOFT
TISSUE NIPPER



Goldman-Fox
10 cm
0103-60

small size for use
in limited access areas

BONE RONGEURS



Luer
14.5 cm
0103-10



Mini Friedman
12 cm
0103-25



Blumenthal
15 cm
0103-30



Blumenthal
14 cm
0103-31

BONE THICKNESS GAUGES



0491-2



17.5 cm
0491-1



15.5 cm
0491-2

MEMBRANE
PLACEMENT
INSTRUMENT



Buser
MV1883
Asa Light MV

BONE WELL



POCKET PROBES



DEPTH GAUGE



SALIVA EJECTORS
Bone filters



CALIPER

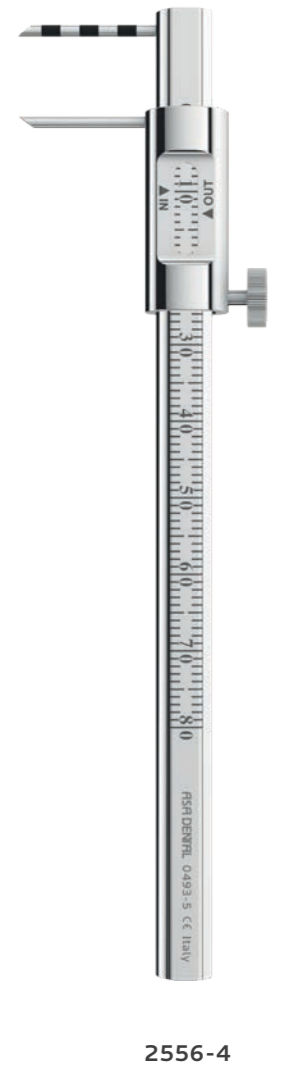

BUR HOLDERS

Aluminum, suitable for steam sterilizing

with rim, 24 CA holes
(big burs)

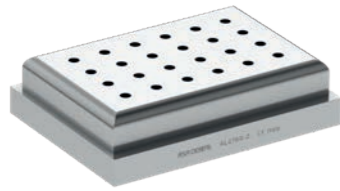

AL2760-2

with rim, 24 FG/CA holes
(small/big burs)

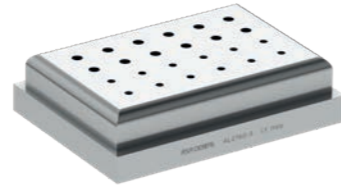

AL2760-3

48 CA holes
(big burs)



AL2762-2

Colored silicone with a plastic cover

lid
non autoclavable



AL2761-U

autoclavable
atoxic food silicon

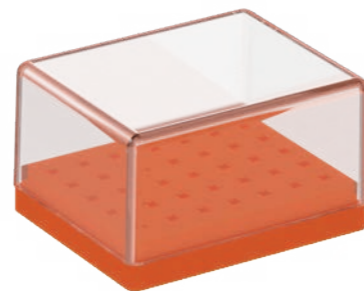

Orange
S2760-A

autoclavable
non-toxic food silicon

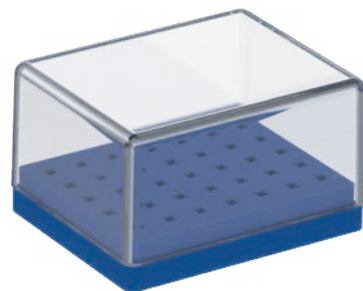

Blue
S2760-C

BONE COMPACTORS

PERIODONTAL POCKET MARKERS



1
MV1230-1



2
MV1230-2

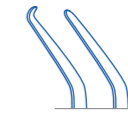

1 (Crane-Kaplan)
Goldman-Fox
15 cm
0650-1

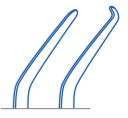

2 (Crane-Kaplan)
Goldman-Fox
15 cm
0650-2

TISSUE PLIERS

TISSUE PLIERS
suture pliers



1 Adson 12 cm 0620-1
 1 Adson 1x2 12 cm 0621-1
 1 Semken-Taylor 12.5 cm 0630-1
 2 Semken-Taylor 12.5 cm 0630-2



16 cm PR0625-2
 17 cm PR0625-3

MEMBRANE HOLDING TWEEZERS

IMPLANT HOLDING TWEEZERS



10.5 cm 0660-1
 9 cm 0660-2 with ring tips



16.5 cm 0661-1
 14.5 cm 0661-2
 14.5 cm 0661-3

INSTRUMENT KIT FOR IMPLANT SURGERY

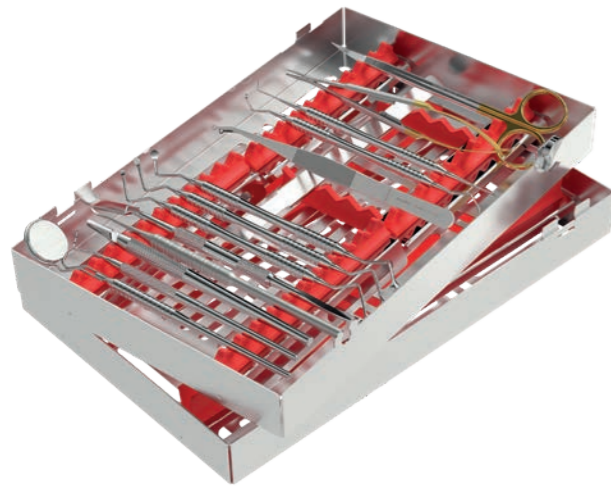

Implant surgery kit
SPR2781-I

ML2101	mouth mirror handle	
2230-5	double sided mouth mirrors	5
0702L-15	periodontal pocket probes	CP-15
0350-5	scalpel handle and blade	5
PR1857-1	exciser	
MV1851-PR3	Prichard periosteal	PR3
1855-23	Seldin retractor	23
ML2001-85	Lucas bone curette	85
ML2001-87	Lucas bone curette	87
ML2001-88	Lucas bone curette	88
PR0625-2	tissue pliers	
ML1806-2RL	periodontal instrument	2R/2L
ML1806-4RL	periodontal instrument	4R/4L
PR0460-15TC	Castroviejo needle holder	
0309-2TC	gum scissors	2TC
2780-1R	instrument cassette	

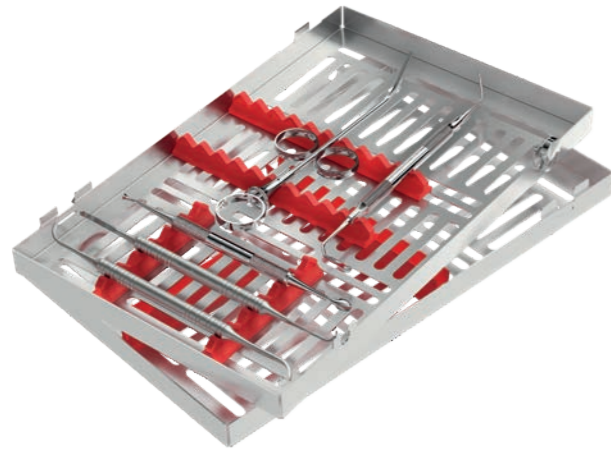

Maxi sinus lift kit
SPR0496

PR1859-1	maxillary sinus instrument	
PR1859-2	maxillary sinus instrument	
MV1231-1	bone applicator	
0490-1	bone injector	
MV1856-2	maxillary sinus instrument	2
2770-3R	instrument cassette	

INSTRUMENT KIT FOR IMPLANT SURGERY



Mini sinus lift kit
SPR0495

0495-1	osteotomes	
0495-2	osteotomes	
0495-3	osteotomes	
0495-4	osteotomes	
0495-5	osteotomes	
0495-6	osteotomes	
1881	mead mallet	
2770-1R	instrument cassette	

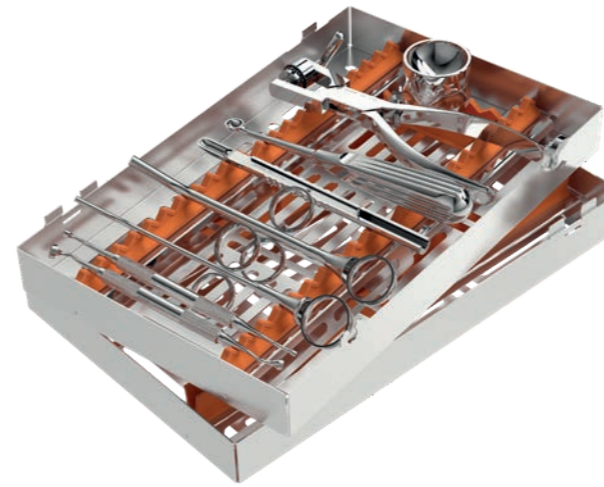

288 x 182 x h. 60 mm
S2780-IMP

1030-4	bone well	
1846	bone mill	
2014-3	bone curettes	3
0494-1	straight bone scraper	
0490-2	bone injector	
0490-1	bone injector	
MV1230-1	bone compactor	1
MV1230-2	bone compactor	2
2780-1A	instrument cassette	

INSTRUMENT KIT FOR IMPLANT SURGERY



Mini sinus lift kit
S0498-8

0498-1B4	concave osteotome	1B4
0498-2C4	concave osteotome	2C4
0498-30B4	angular osteotome	30B4
0498-PF4	flat osteotome	PF4
1902-2	Towner-Jacquette scaler	U15/30
1809-1	Goldman-Fox Universal scaler	1
1831-32	Jacquette curette	31/32
2001-87	Lucas bone curette	87
S2702	perforated instrument tray complete with insert frame	



kit Goracci
S3001-20

0300-1	gum scissors, straight	
0601-1	Flagg cotton & dressing pliers	
0704-23D2	explorer d. e.	23/17A
0903-2	cement spatula, double-ended	2
1101-2	Heidemann separating spatulas	2
1200-2	double-ended filling instruments	2
1202-1L	double-ended filling instruments	1L
1202-2L	double-ended filling instruments	2L
1211-1T	Tanner filling instrument	1T
1301	placement instrument	
1500-02	Hollenback amalgam cavers	1/2
1600-1	cleoid-discoid	1
1601-1	gingival margin trimmer	26
1601-2	gingival margin trimmer	27
1700-1	double-ended excavator	1
1700-2	double-ended excavator	2
1700-3	double-ended excavator	3
1700-4	double-ended excavator	4
2102-IN	mirror handle	
2200-5	mouth mirror plane	5
S2721-2	instrument tray with a perforated base and insert frame	

INSTRUMENT KIT FOR IMPLANT SURGERY



S3003-9

MV1850-M9	Molt periosteal	M9
MV1851-PR3	Prichard periosteal	PR3
MV1850-GF	Goldman-Fox periosteal	GF
MV1803-D	Kirkland knife	15K/16K
1881	Mead mallet	
0446TH-14TC	Castroviejo needle holder	
0435-17TC	Mathieu needle holder	
0350-3	scalpel handle	3
S2722-1	perforated instrument tray complete with insert frame	



S3003-11

0350-3	scalpel handle	3
2602-1	Sternberg retractor	
0304-2	Goldman-Fox scissors	2
MV1850-M9	Molt periosteal	M9
MV1851-PR3	Prichard periosteal	PR3
0415-15TC	Crite-Wood needle holder	
0631-1	Semken Taylor tissue plier	1
0700-23	explorer with an anatomic handle	23
2102-IN	mouth mirror handle	
2200-5	mouth mirror plane	5
0351-11	scalpel blades (100 pcs)	11
S2722-1	perforated instrument tray complete with insert frame	

RESTORATIVE

MADE IN ITALY



MAKE PEOPLE SMILE

This simple yet powerful idea drives every decision we make at Asa Dental. Whenever we choose materials, technologies, designs and manufacturing processes, we make sure they will help dental professionals make people smile, anywhere in the world. Our restorative instruments are the result of precise, careful planning and design which is rendered concrete through advanced technologies and skilled hands. This is how we manufacture durable excavators, precise carvers, effective burnishers, innovative isolation instruments and all the other products that allow practitioners to deliver aesthetically and functionally superior results.

- F2 Vision dental dam
- F6 Dental dam clamps
- F11 Dental dam instruments
- F16 Excavators
- F21 Cavity preparation instruments
- F23 Amalgam carriers
- F23 Amalgam wells
- F25 Spatulas
- F28 Filling instruments
- F38 Modeling instruments
- F41 Operative instruments
- F42 Crown instruments
- F46 Hemostats
- F47 Scissors
- F48 Matrices
- F50 Composite instruments





VISION® SHADE

Dental dam
 pack of 60 dental dams
 (black, mint-flavored)
 185x130 mm



VS3045

Dam frame
 stainless steel
 10x15 cm

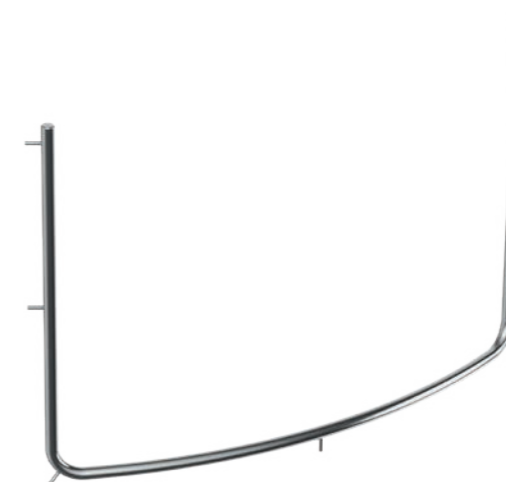

VV3040-2

Magnetic locking tray
 stainless steel



VV2731-6

Magnetic locking tray
 stainless steel with 6 clamps

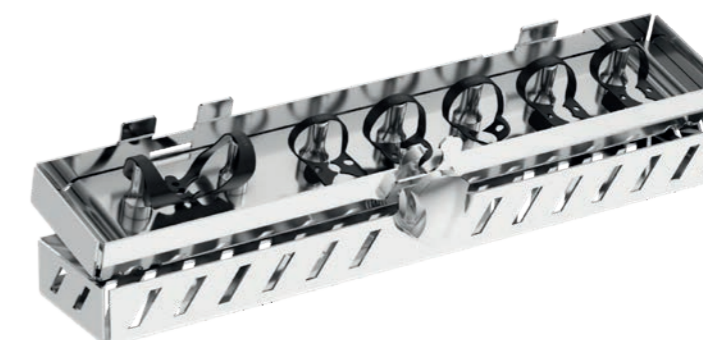

SVS2731-6

VISION®
 dental dam reinvented

VISION

VISION® SHADE

Clamps



210
winged
perfect for anterior teeth
VS3051-210



12A
winged, serrated
for lower right/upper left molars
VS3052-12A



W4
wingless
for upper/lower molars
VS3052-W4



2
winged
for lower/upper premolars
VS3052-2



13A
winged, serrated
for lower left/upper right molars
VS3052-13A



W8
wingless
for upper/lower molars
VS3052-W8

Clamp forceps
stainless steel



VV3030

Punch forceps
stainless steel

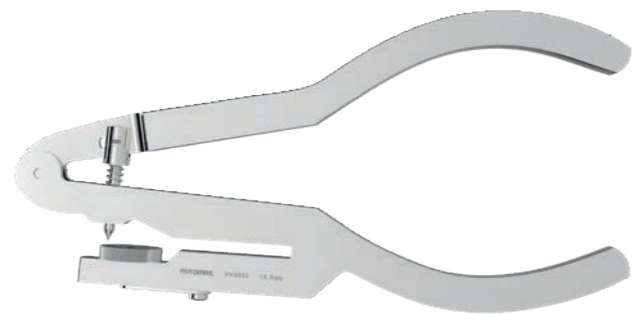

VV3033

Hole punching template
Stainless steel

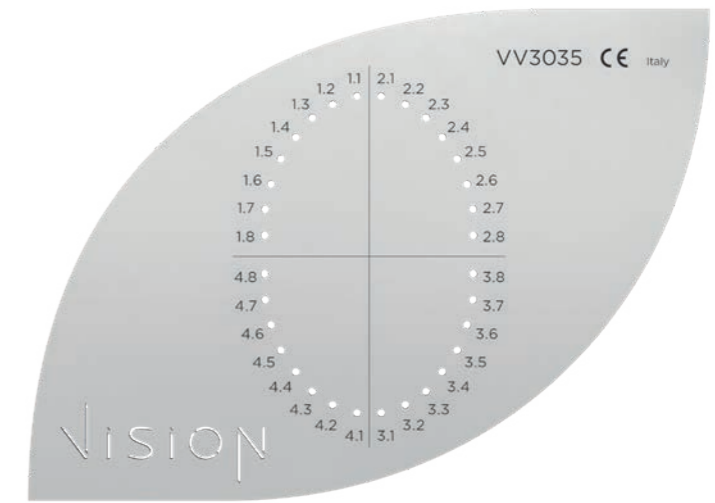

VV3035

Marker
food-safe



VVPEN

Vision Shade Kit



SVS3000

TOOTH NUMBERING

Maxillary teeth	Patterns
18 17 16	4 W4 8 W8 8A W8A 12A 14 14T W14 14A W14A 26 51 205 202
15 14	0 W0 1 1T W1 2A 2AT W2A 29
13 12 11 21 22 23	9 9T 212 210
24 25	0 W0 1 1T W1 2A 2AT W2A 29
26 27 28	4 W4 8 W8 8A W8A 13A 14 14T W14 14A W14A 26 51
Mandibular teeth	Patterns
38 37 36	3 W3 7 W7 8A W8A 13A 14 14T W14 14A W14A
35 34	0 W0 2A 2AT W2A 2 2T W2 29
33 32 31 41 42 43	00 9 9T 212 210
44 45	0 W0 2 2T W2 2A 2AT W2A 29
46 47 48	3 W3 7 W7 12A 14 14T W14 14A W14A

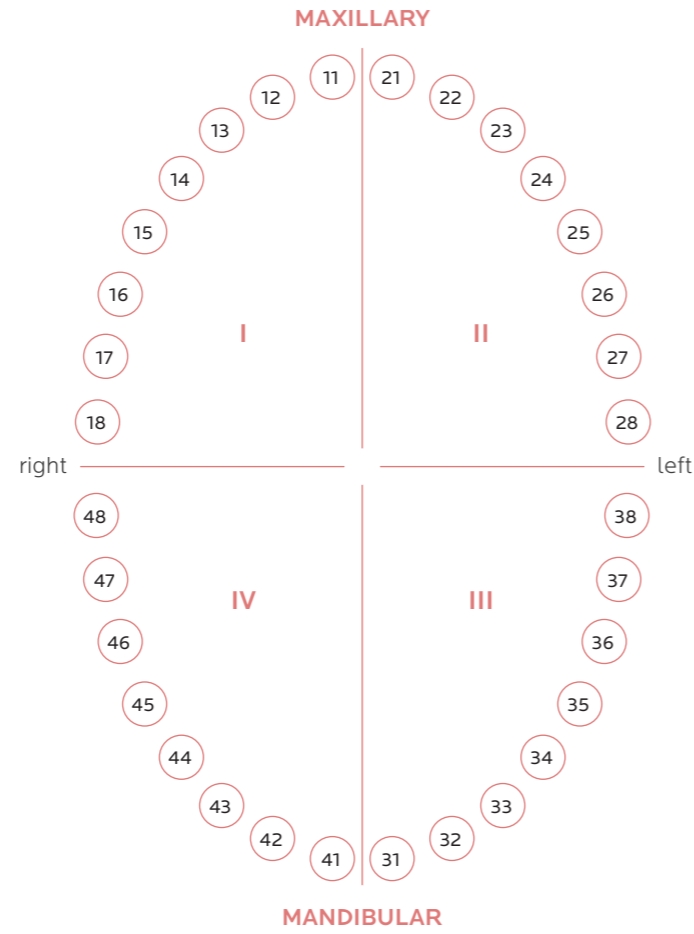

CLASSIFICATION

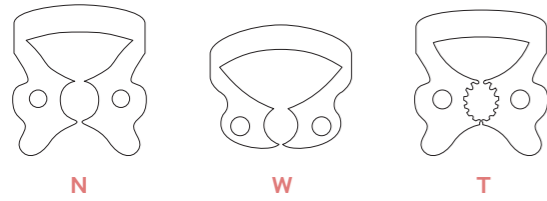

- N** Standard (winged clamp)
- W** Wingless (wingless clamp)
- T** Tiger (serrated jaws)

DENTAL DAM CLAMPS
Anterior

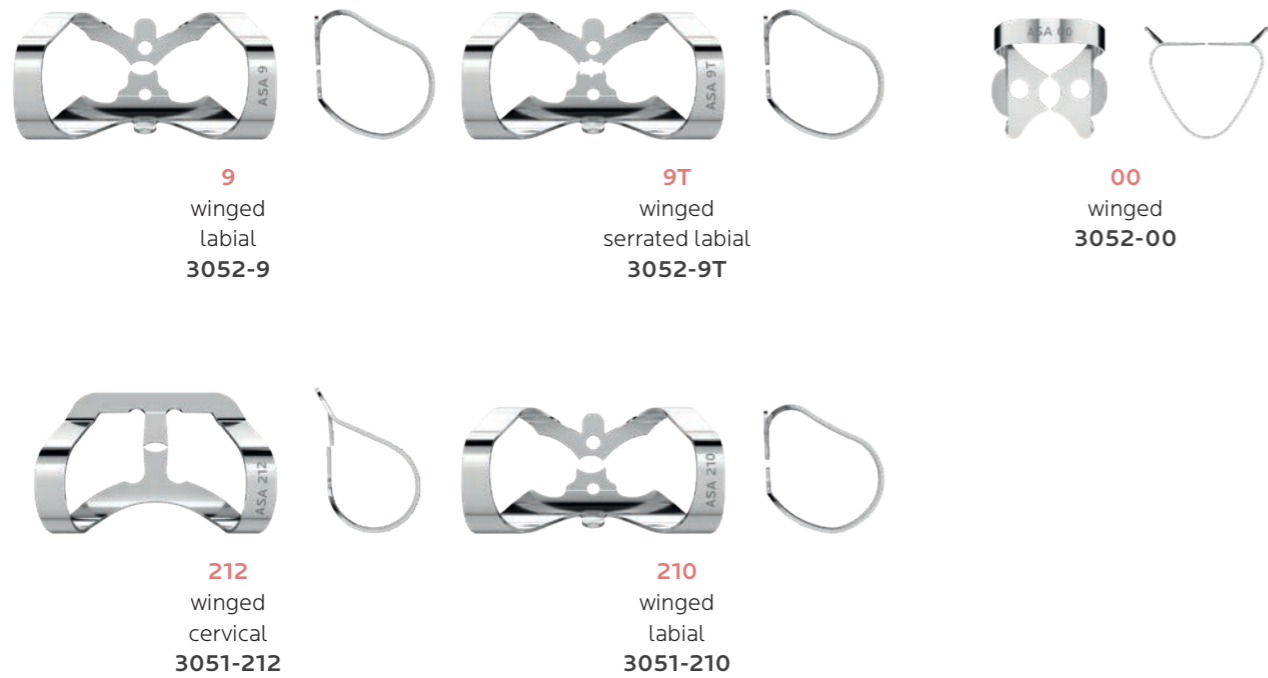

Premolars

for small, elongated or narrow teeth



for general use, with adjustable wings that adapt to the gingival curvature



for premolars, with large necks



Premolars

for lower premolars, general use



primarily for lower premolars

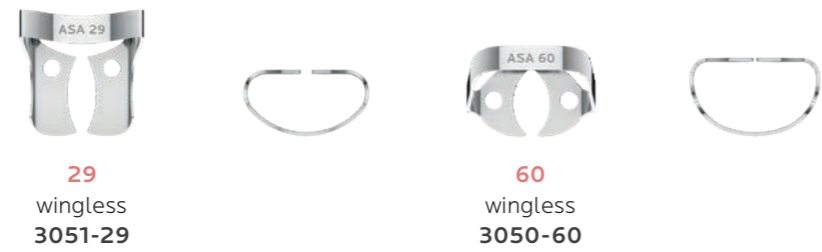

Molars

for small lower molars



Molars

for square lower molars



for molar roots



for round, partially broken, undersized or slanted molars



for upper molars



Molars

for small molars with round collars



4
winged
3052-4

W4
wingless
3052-W4

for round upper molars



8
winged
3052-8

W8
wingless
3052-W8

for partially broken molars



12A
winged, serrated
3052-12A

13A
winged, serrated
3052-13A

for large, partially broken, irregularly shaped or slanted molars



14A
winged
3052-14A

W14A
wingless
3052-W14A

for large upper molars



202
winged
3051-202

205
winged
3051-205

DENTAL DAM INSTRUMENTS

AsaLady

products ergonomically designed for women's hands:

- smaller and lighter handles
 - smaller finger holes
 - reduced size
- code starts with "W" or "SW"

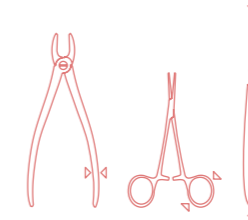

latex dam

vacuum packed
36 pz / confezione

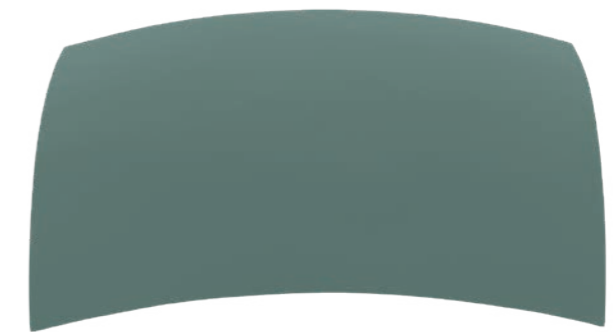

15x15 cm (6"x 6")
3045

Punch forceps



Ainsworth
17 cm
3032



Ainsworth
17 cm
W3036



Ivory
16.2 cm
3033

DENTAL DAM INSTRUMENTS

Rubber dam frame
stainless steel

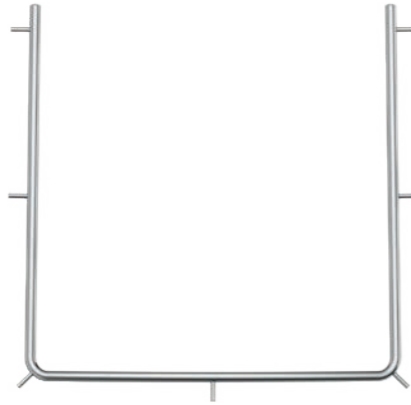

10x10 cm
3040-1

Dental dam placed on an upper molar

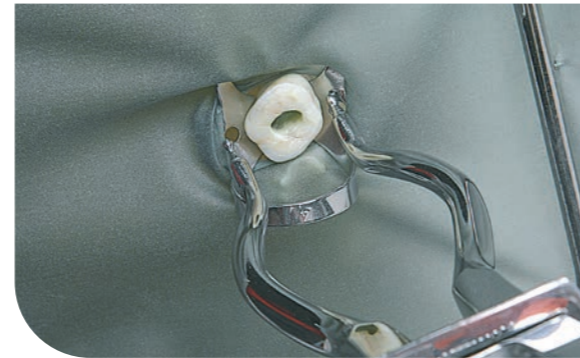

Rubber dam frame
sterilizable plastic,
x-ray compatible

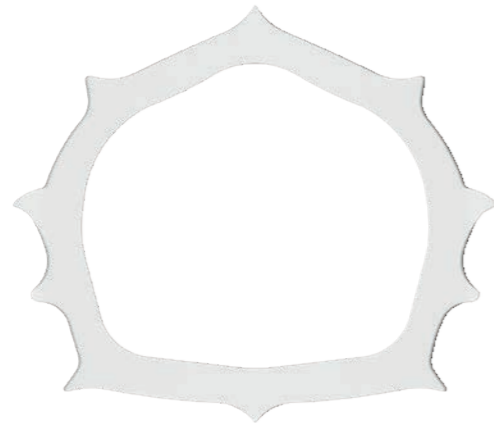

3041-1

Clamp forceps



Ivory lightweight
17 cm
3030



Ivory lightweight
16 cm
W3035



Brewer
17.5 cm
3031



Stoke
17.5 cm
3034

INSTRUMENT KIT FOR DENTAL DAMS



S3000

Dental dam instrument kit manufactured according to the instructions of Prof. Guido Goracci, Tenured Professor at the Department of Conservative Dentistry at La Sapienza University in Rome.

3040-1	stainless steel dental dam frame	
3031	Brewer clamp forceps	
3033	Ivory punch forceps	
3050-60	wingless clamp for premolars	60
3051-26	wingless clamp for molars	26
3051-51	wingless clamp for molars	51
3051-29	wingless clamp for premolars	29
3051-202	winged clamp for molars	202
3051-205	winged clamp for molars	205
3051-212	winged posterior clamp	212
3051-210	winged anterior clamp	210
2731-1	stainless steel dental dam clamp tray	
2720-L	stainless steel tray	
2720-U	stainless steel lid	
2730-3	stainless steel insert frame	

Insert frame for dental dam tools

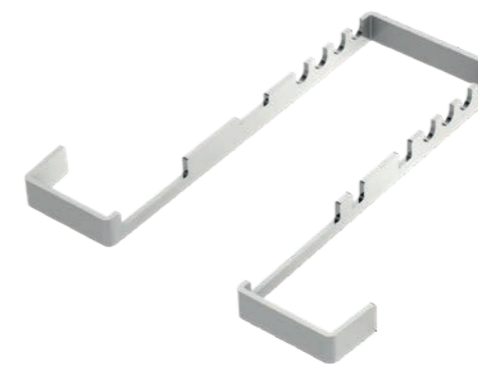

2730-3

INSTRUMENT KIT FOR DENTAL DAMS



S2731-1

stainless steel dental dam clamp tray with 8 clamps

3050-60	wingless clamp for premolars	60
3051-26	wingless clamp for molars	26
3051-51	wingless clamp for molars	51
3051-29	wingless clamp for premolars	29
3051-202	winged clamp for molars	202
3051-205	winged clamp for molars	205
3051-212	winged posterior clamp	212
3051-210	winged anterior clamp	210
2731-1	stainless steel dental dam clamp tray	

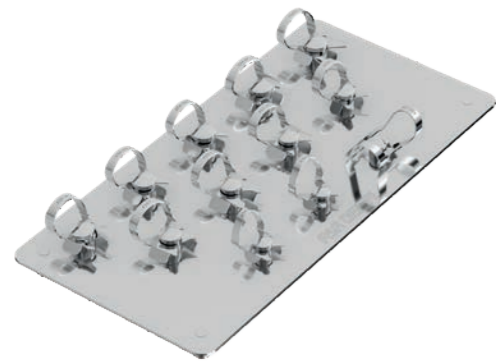

S2731-12

stainless steel dental dam clamp tray with 12 clamps

3051-212	winged posterior clamp	212
3052-00	winged premolar clamp	00
3052-0	winged premolar clamp	0
3052-1	winged premolar clamp	1
3052-2A	winged premolar clamp	2A
3052-3	winged clamp for molars	3
3052-7	winged clamp for molars	7
3052-8	winged clamp for molars	8
3052-8A	winged molar root clamp	8A
3052-12A	serrated and winged molar clamp	12A
3052-13A	serrated and winged molar clamp	13A
3052-14	winged clamp for molars	14
2731-1	stainless steel dental dam clamp tray	



2731-1

stainless steel dental dam clamp tray (without clamps)

HANDLE

SINGLE-ENDED

Asa35
(stainless steel)
ø 3.5 mm



Asa60
(stainless steel)
ø 6.0 mm



Octagonal
(stainless steel)
ø 5.5 mm



DOUBLE-ENDED

Asa60
(stainless steel)
ø 6.0 mm



Asa Light MV
(stainless steel, hollow)
ø 8.0 mm



Leonardo ML
(stainless steel)
ø 7.0 mm



Octagonal
(stainless steel)
ø 5.5 mm



● **Alu80**
(aluminum, hollow)
ø 8.0 mm



● **AsaWave RC**
(plastic resin in PPSU with a steel core)
ø 7.5 / 14.5 mm



HOW TO USE THE INFORMATION

- 1/2 Wedelstaedt → model + scientific name
- MV1604-02 → Asa Dental code
- Asa Light MV → handle option

AsaLady

products ergonomically designed for women's hands:

- smaller and lighter handles
- smaller finger holes
- reduced size

code starts with "W" or "SW"

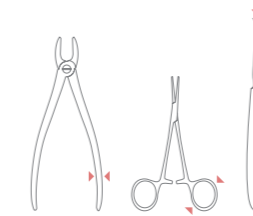

top view



side view

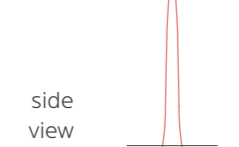

front view



EXCAVATORS
Curettes

EXCAVATORS
Curettes

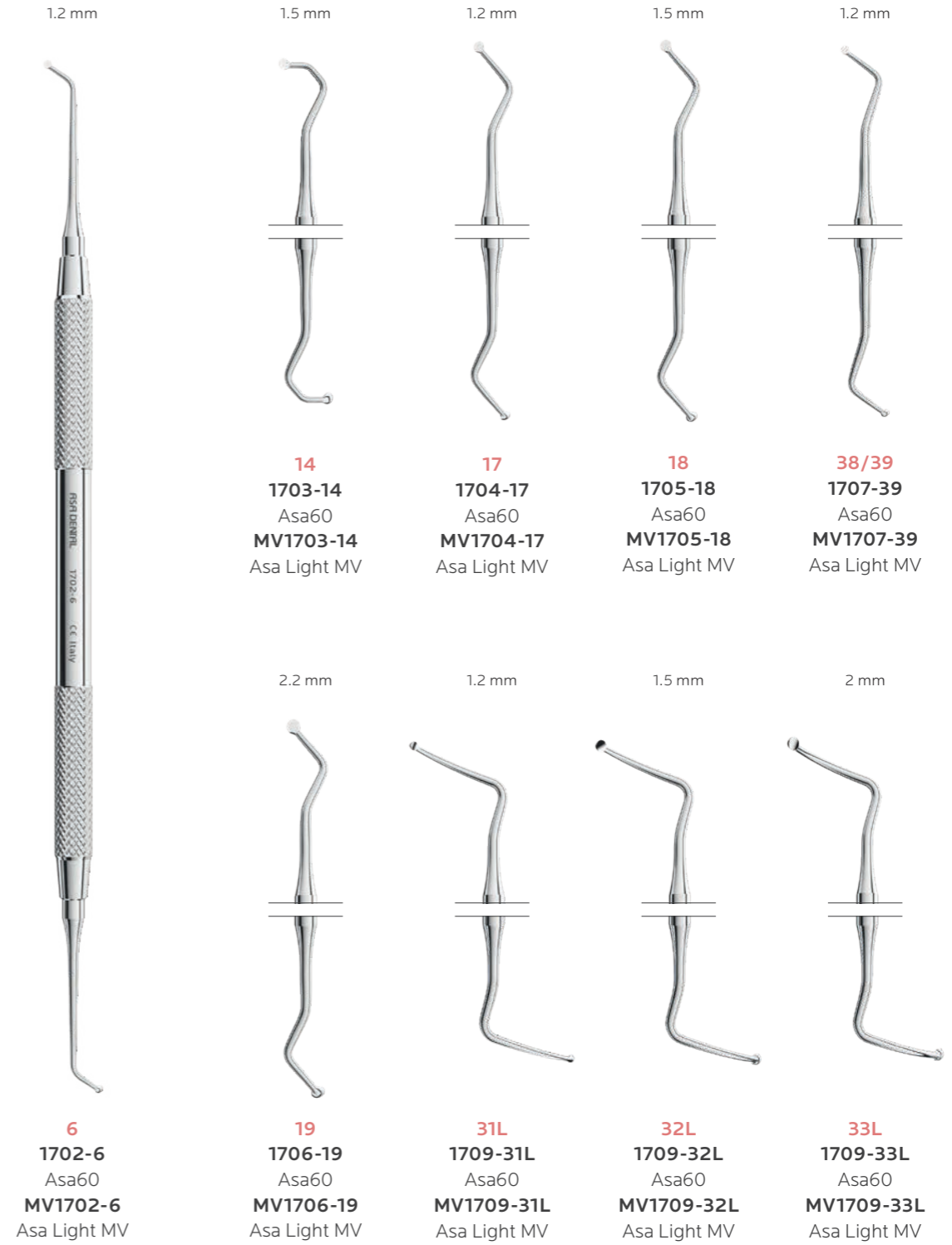
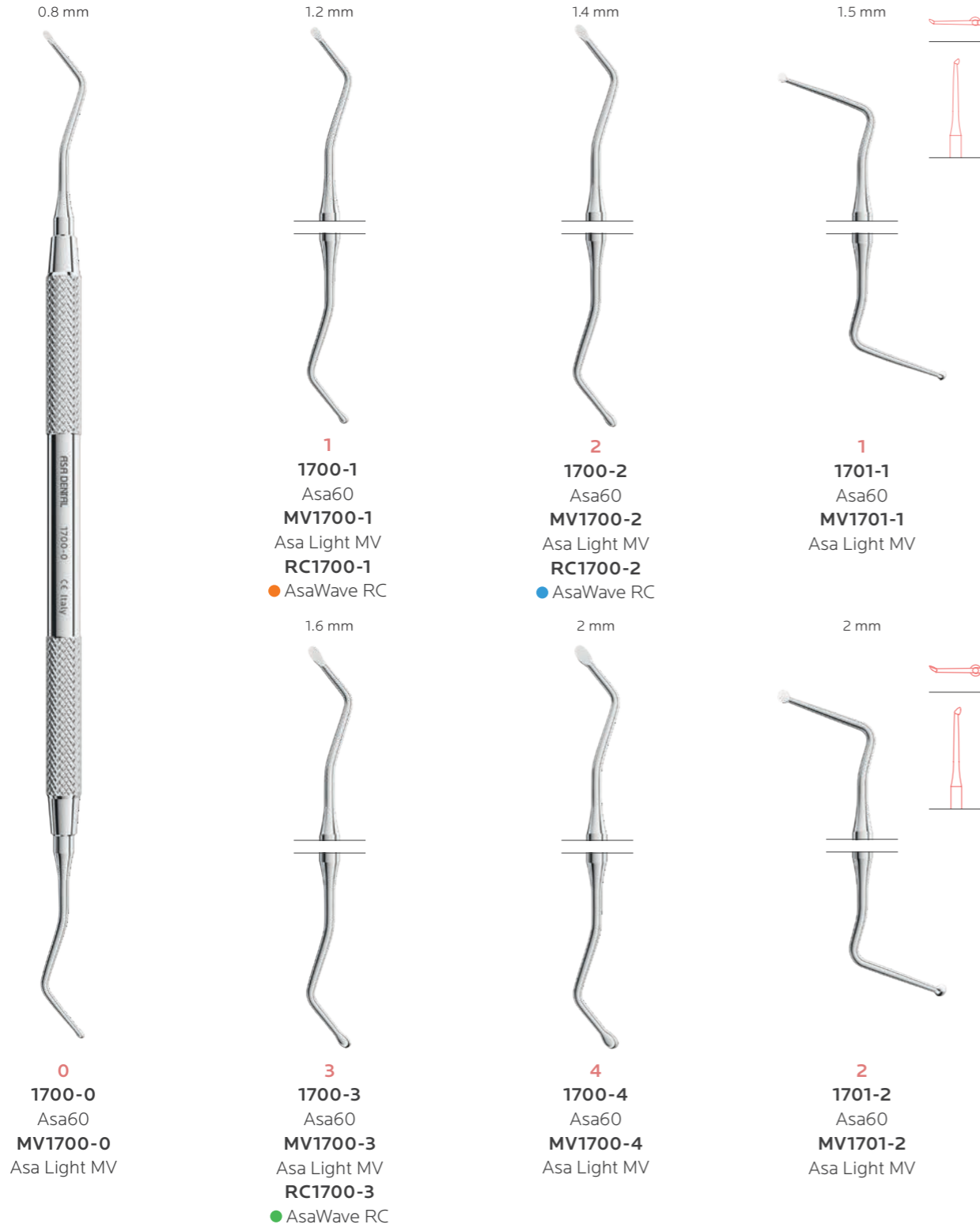

Set of 5



Model	Set Code	Handle
0 · 1 · 2 · 3 · 4	SMV1700	Asa Light MV
0 · 1 · 2 · 3 · 4	S1700	Asa60
0	S1700-0	Asa60
1	S1700-1	Asa60
2	S1700-2	Asa60
3	S1700-3	Asa60
4	S1700-4	Asa60

EXCAVATORS
Oval currettes



17W
1704-17W
Asa60
MV1704-17W
Asa Light MV

18W
1705-18W
Asa60
MV1705-18W
Asa Light MV

19W
1706-19W
Asa60
MV1706-19W
Asa Light MV

EXCAVATORS
ASH



243
1711-243
Asa60
ML1711-243
Leonardo ML

G2
1711-G2
Asa60
ML1711-G2
Leonardo ML

EXCAVATORS
SS. white type

Set of 6



Model	Set Code	Handle
5 · 14 · 17 · 18 · 19 · 20	S1710-6	Asa60
5 · 14 · 17 · 18 · 19 · 20	SML1710-6	Leonardo ML



5
1710-5
Asa60
ML1710-5
Leonardo ML

14
1710-14
Asa60
ML1710-14
Leonardo ML

17
1710-17
Asa60
ML1710-17
Leonardo ML

18
1710-18
Asa60
ML1710-18
Leonardo ML

19
1710-19
Asa60
ML1710-19
Leonardo ML

20
1710-20
Asa60
ML1710-20
Leonardo ML

EXCAVATORS
Darby-Perry

0.8 mm 0.8 mm 1 mm 1 mm 1 mm 2 mm

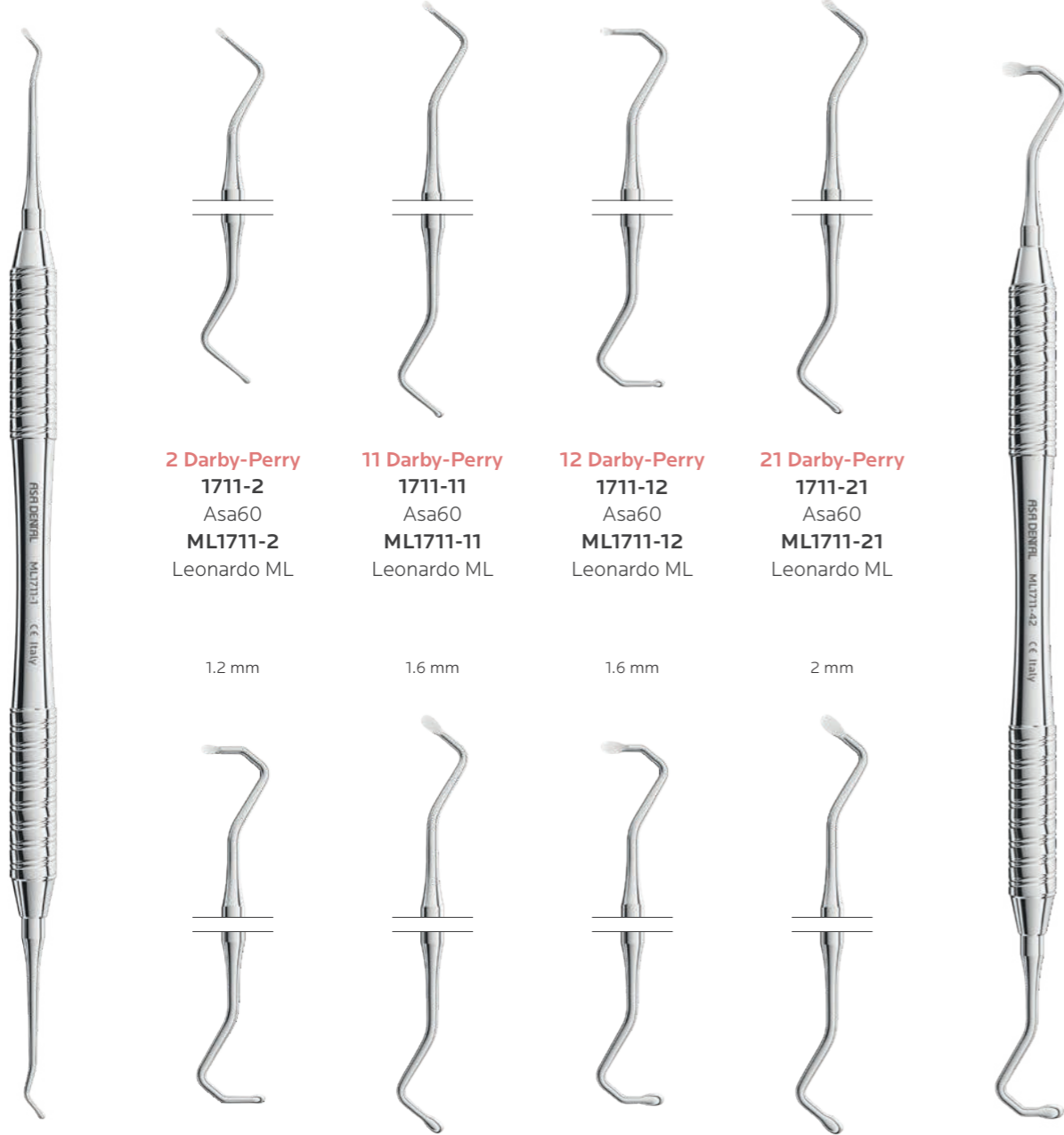

2 Darby-Perry
1711-2
Asa60
ML1711-2
Leonardo ML

11 Darby-Perry
1711-11
Asa60
ML1711-11
Leonardo ML

12 Darby-Perry
1711-12
Asa60
ML1711-12
Leonardo ML

21 Darby-Perry
1711-21
Asa60
ML1711-21
Leonardo ML

1.2 mm 1.6 mm 1.6 mm 2 mm

1 Darby-Perry
ML1711-1
Leonardo ML
1711-1
Asa60L

22 Darby-Perry
1711-22
Asa60
ML1711-22
Leonardo ML

31 Darby-Perry
1711-31
Asa60
ML1711-31
Leonardo ML

32 Darby-Perry
1711-32
Asa60
ML1711-32
Leonardo ML

41 Darby-Perry
1711-41
Asa60
ML1711-41
Leonardo ML

42 Darby-Perry
ML1711-42
Leonardo ML
1711-42
Asa60

CAVITY PREPARATION INSTRUMENTS
Gingival margin trimmers



2 Black/27
mesial
1601-2
Asa60
MV1601-2
Asa Light MV

3 Black/28
distal
1601-3
Asa60
MV1601-3
Asa Light MV

1 Black/26
distal
1601-1
Asa60
MV1601-1
Asa Light MV

4 Black/29
mesial
1601-4
Asa60
MV1601-4
Asa Light MV

1 Black/77-78
distal
1602-1
Asa60
MV1602-1
Asa Light MV

2 Black/79-80
mesial
1602-2
Asa60
MV1602-2
Asa Light MV

CAVITY PREPARATION INSTRUMENTS
Hatchets



1 Black/53-54
1603-1
Asa60
MV1603-1
Asa Light MV

2 Black/51-52
1603-2
Asa60
MV1603-2
Asa Light MV

CAVITY PREPARATION INSTRUMENTS
Chisels



1/2 Wedelstaedt
1604-02
Asa60
MV1604-02
Asa Light MV

3/4 Wedelstaedt
1604-04
Asa60
MV1604-04
Asa Light MV

5/6 Wedelstaedt
1604-06
Asa60
MV1604-06
Asa Light MV

AMALGAM CARRIERS



AMALGAM WELLS
cold sterilization only



Ø 3.5 cm
h. 3.5 cm
1030-1

Ø 2 cm
h. 4 cm
1030-2

Ø 2 cm
h. 2.5 cm
1030-3

AMALGAM CARRIERS

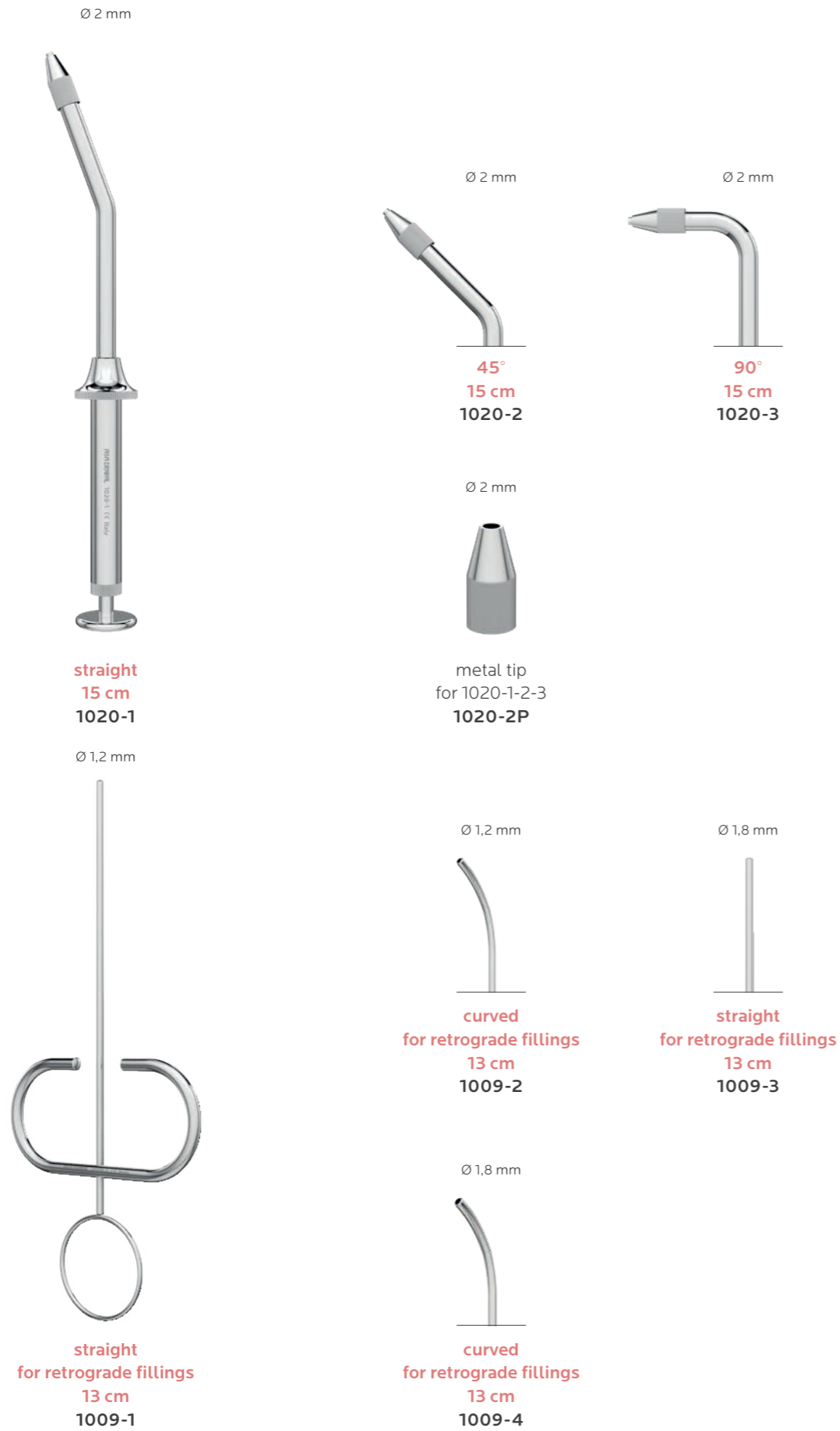

CEMENT SPATULAS

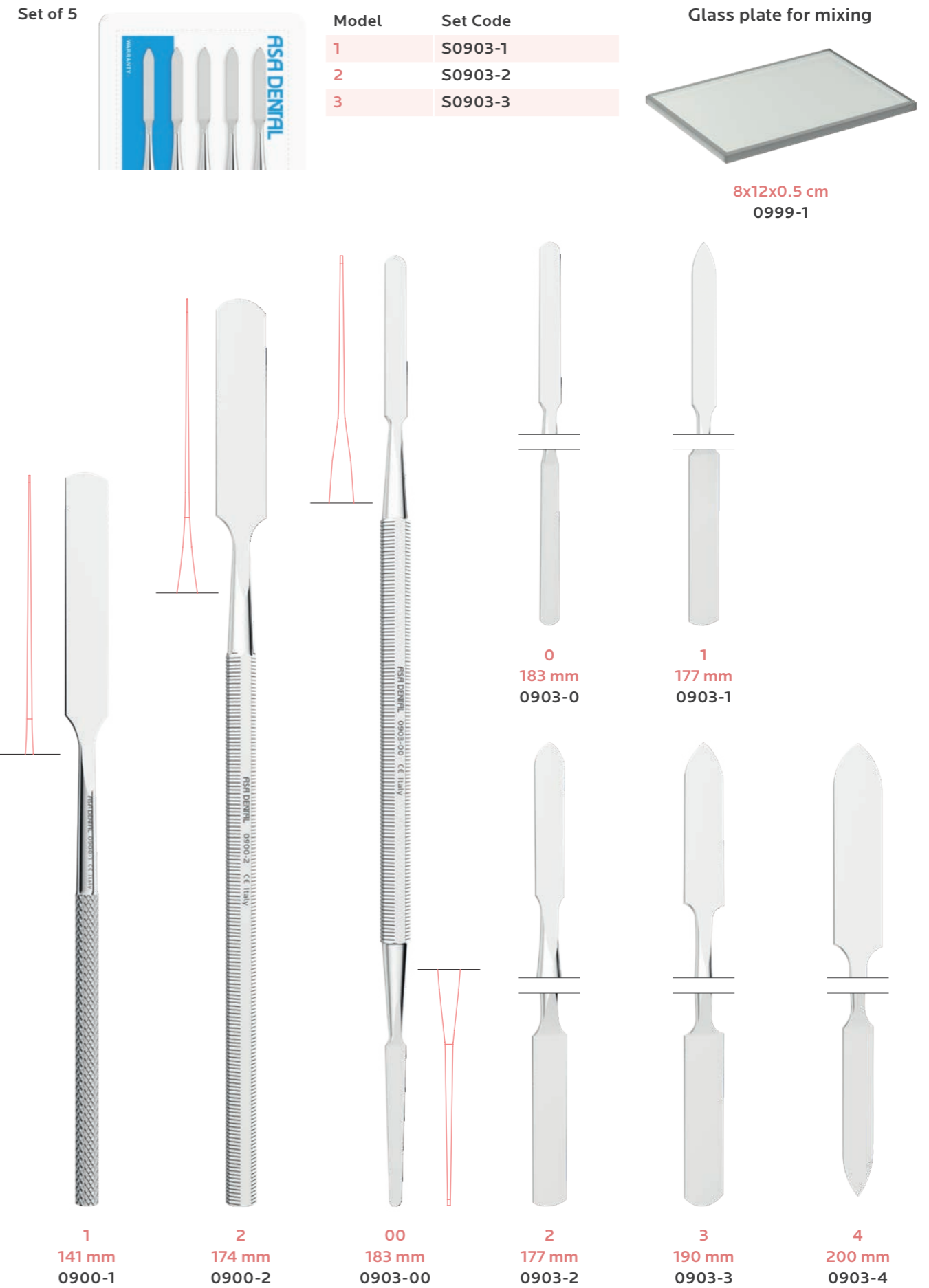

HEIDEMANN SEPARATING SPATULAS



1 1100-1 Octagonal	2 1100-2 Octagonal	3 1100-3 Octagonal	1 1101-1 Asa60	2 1101-2 Asa60	3 1101-3 Asa60
---------------------------------	---------------------------------	---------------------------------	-----------------------------	-----------------------------	-----------------------------

HEIDEMANN SEPARATING SPATULAS

Set of 5

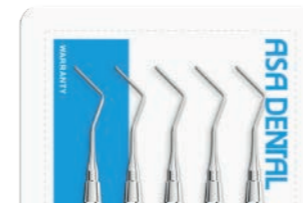

Model	Set Code	Handle
1	S1102-1	Asa60
2	S1102-2	Asa60
3	S1102-3	Asa60

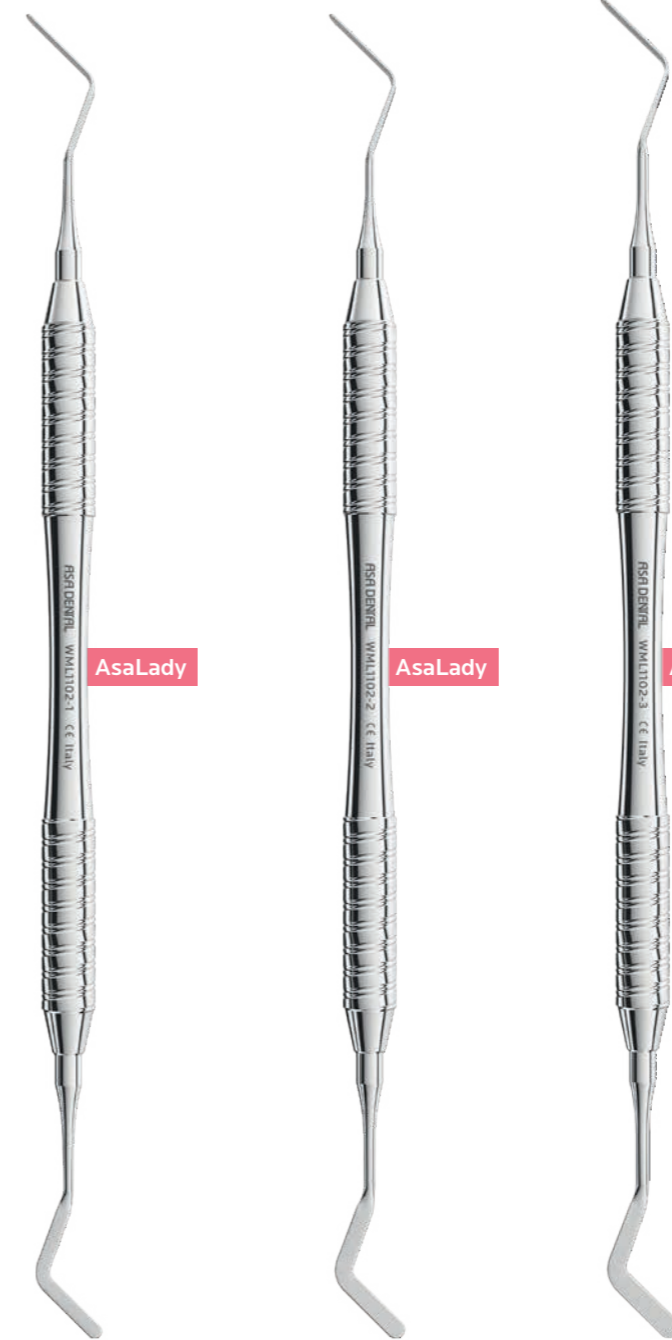

1 ML1102-1/WML1102-1 Leonardo ML 1102-1 Asa60 MV1102-1 Asa Light MV RC1102-1 ● AsaWave RC	2 WML1102-2 Leonardo ML 1102-2 Asa60 MV1102-2 Asa Light MV RC1102-2 ● AsaWave RC	3 WML1102-3 Leonardo ML 1102-3 Asa60 MV1102-3 Asa Light MV RC1102-3 ● AsaWave RC
--	---	---

HEIDEMANN SEPARATING SPATULAS

with titanium nitride-coated tips



1 1102T-1 Asa60	2 1102T-2 Asa60
------------------------------	------------------------------

3
1102T-3
Asa60

AMALGAM FILLING INSTRUMENTS

with titanium nitride-coated tips

Set of 5



Model	Code	Set Code	Handle
1	1200T-1	S1200T	Asa60
2	1202T-2	S1200T	Asa60
1	1204T-1	S1200T	Asa60
1	1102T-1	S1200T	Asa60
2	1102T-2	S1200T	Asa60

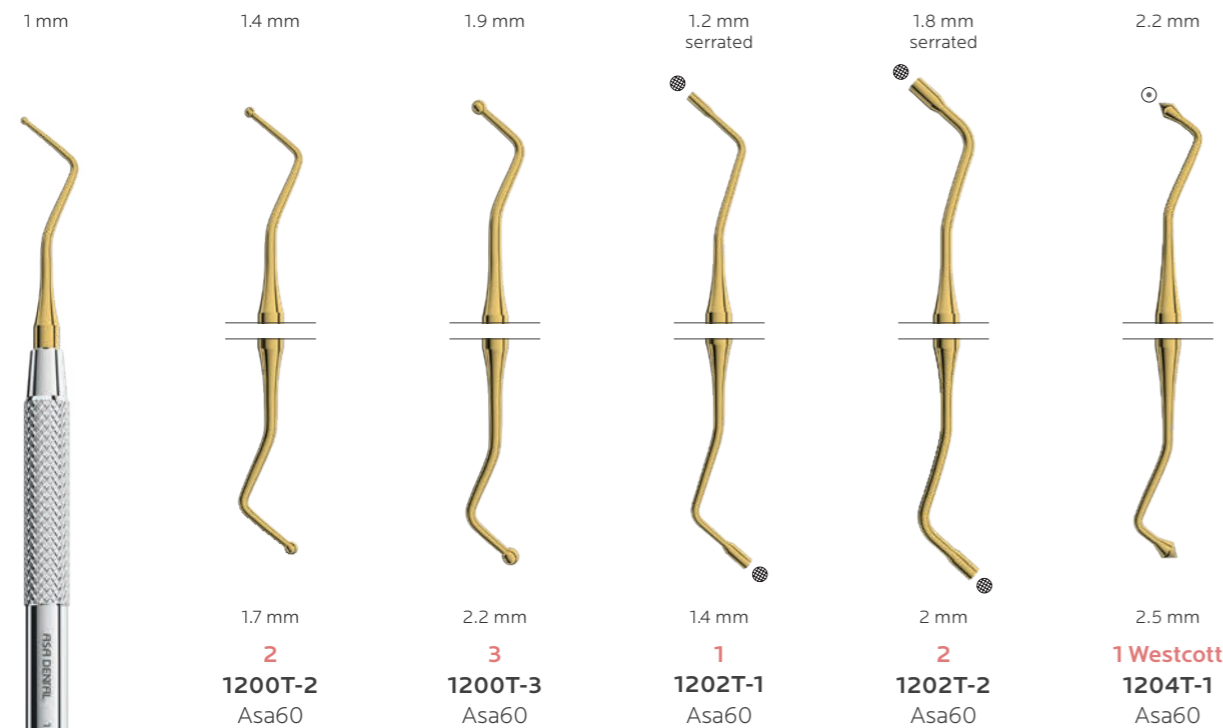

1.2 mm
1
1200T-1
Asa60

1200T-2

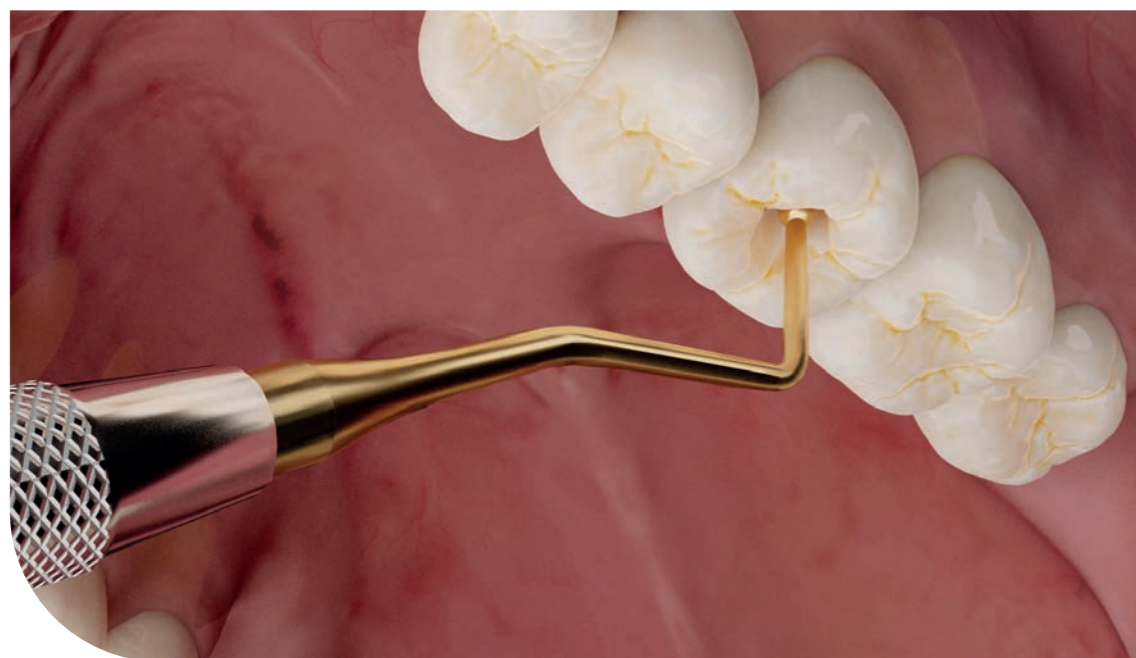

AMALGAM FILLING INSTRUMENTS

Set of 5



Model	Set Code	Handle
1	S1200-1	Asa60
2	S1200-2	Asa60
3	S1200-3	Asa60
4	S1200-4	Asa60
5	S1200-5	Asa60

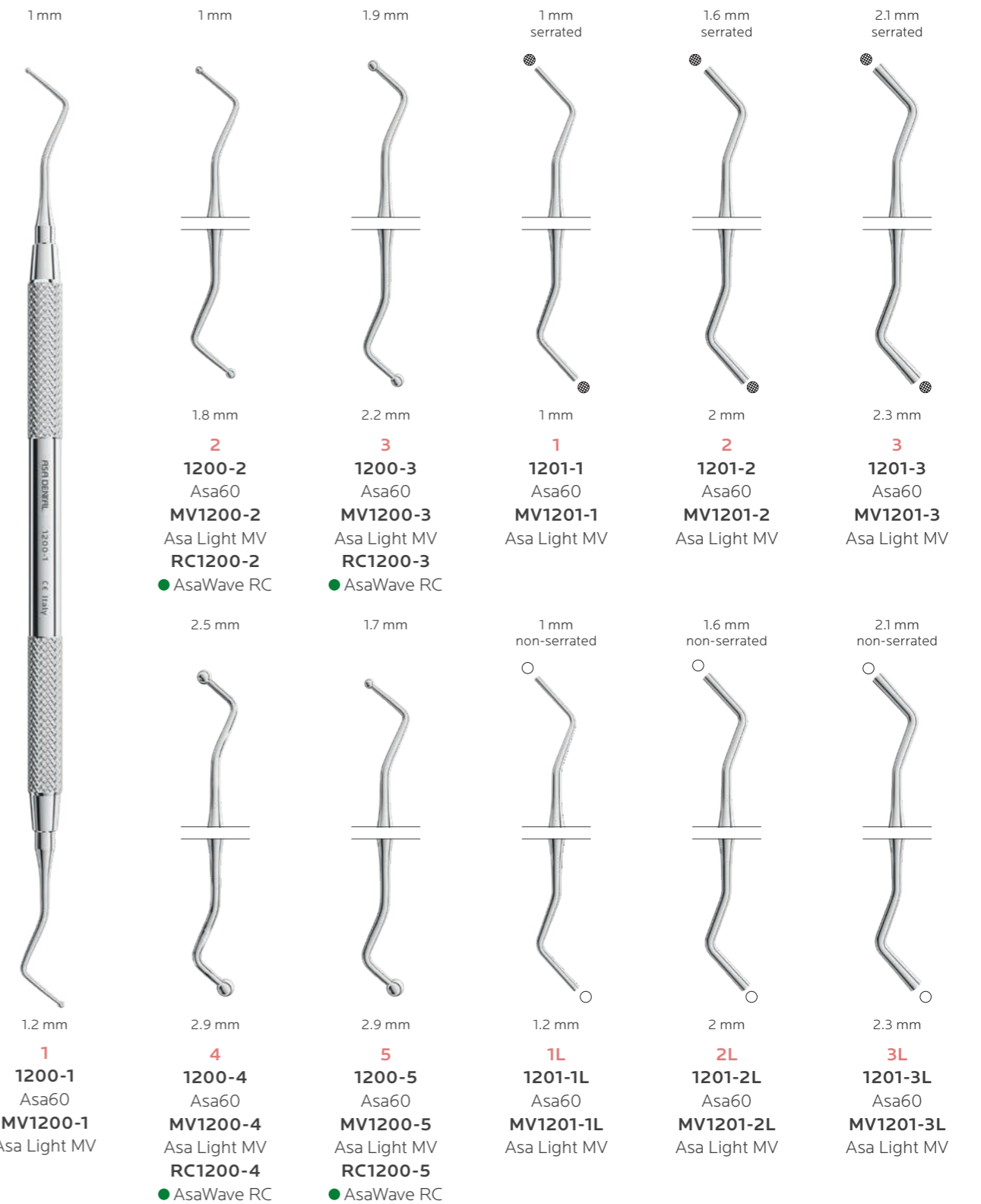

1.2 mm
1
1200-1
Asa60
MV1200-1
Asa Light MV

2.9 mm
4
1200-4
Asa60
MV1200-4
Asa Light MV
RC1200-4
AsaWave RC

2.9 mm
5
1200-5
Asa60
MV1200-5
Asa Light MV
RC1200-5
AsaWave RC

1.2 mm
1L
1201-1L
Asa60
MV1201-1L
Asa Light MV

2 mm
2L
1201-2L
Asa60
MV1201-2L
Asa Light MV

2.3 mm
3L
1201-3L
Asa60
MV1201-3L
Asa Light MV

AMALGAM FILLING INSTRUMENTS

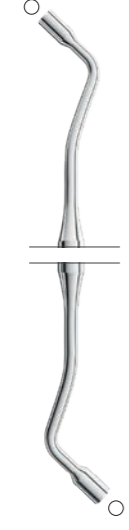
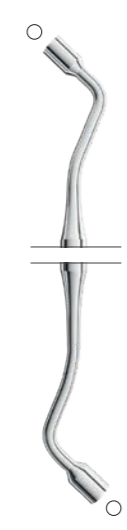
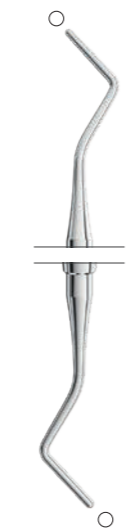
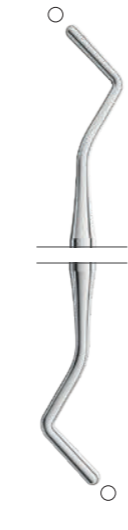
<p>1.2 mm serrated</p>  <p>1.4mm</p> <p>1 1202-1 Asa60 MV1202-1 Asa Light MV</p>	<p>1.8 mm serrated</p>  <p>2 mm</p> <p>2 1202-2 Asa60 MV1202-2 Asa Light MV RC1202-2 AsaWave RC</p>	<p>2.3 mm serrated</p>  <p>2.6 mm</p> <p>3 1202-3 Asa60 MV1202-3 Asa Light MV</p>	<p>3 mm serrated</p>  <p>3.2 mm</p> <p>4 1202-4 Asa60 MV1202-4 Asa Light MV</p>	<p>1.2 mm non-serrated</p>  <p>1.4 mm</p> <p>1L 1202-1L Asa60 MV1202-1L Asa Light MV</p>	<p>1.8 mm non-serrated</p>  <p>2 mm</p> <p>2L 1202-2L Asa60 MV1202-2L Asa Light MV</p>	<p>2.3 mm non-serrated</p>  <p>2.6 mm</p> <p>3L 1202-3L Asa60 MV1202-3L Asa Light MV</p>	<p>3 mm non-serrated</p>  <p>3.2 mm</p> <p>4L 1202-4L Asa60 MV1202-4L Asa Light MV</p>	<p>1 mm</p>  <p>1.2 mm</p> <p>1 1203-1 Asa60 MV1203-1 Asa Light MV</p>	<p>1.4 mm</p>  <p>1.6 mm</p> <p>2 1203-2 Asa60 MV1203-2 Asa Light MV</p>	<p>1.8 mm</p>  <p>2 mm</p> <p>3 1203-3 Asa60 MV1203-3 Asa Light MV</p>
---	---	---	---	---	--	--	--	--	---	--

AMALGAM FILLING INSTRUMENTS

<p>1.5 mm</p>  <p>2 mm</p> <p>1 Ward 1205-1 Asa60 MV1205-1 Asa Light MV</p>	<p>2.4 mm</p>  <p>2.8 mm</p> <p>2 Ward 1205-2 Asa60 MV1205-2 Asa Light MV</p>	<p>1.4 mm</p>  <p>0.8 mm</p> <p>0T Tanner 1211-0T Asa60 MV1211-0T Asa Light MV</p>	<p>2.4 mm</p>  <p>1.4 mm</p> <p>1T Tanner 1211-1T Asa60 MV1211-1T Asa Light MV</p>	<p>1.2 mm</p>  <p>0.8 mm</p> <p>2T Tanner 1211-2T Asa60 MV1211-2T Asa Light MV</p>	<p>1.8 mm</p>  <p>1.5 mm</p> <p>3T Tanner 1211-3T Asa60 MV1211-3T Asa Light MV</p>	<p>1 mm serrated</p>  <p>1.4 mm</p> <p>01 Marquette 1212-01 Asa60 MV1212-01 Asa Light MV</p>	<p>1.5 mm</p>  <p>1 mm</p> <p>H1 Hollenback 1213-H1 Asa60 MV1213-H1 Asa Light MV</p>	<p>3 mm</p>  <p>2 mm</p> <p>H2 Hollenback 1213-H2 Asa60 MV1213-H2 Asa Light MV</p>	<p>2.6 mm</p>  <p>1 mm</p> <p>H3 Hollenback 1213-H3 Asa60 MV1213-H3 Asa Light MV</p>	<p>1.8 mm</p>  <p>2.6 mm</p> <p>H4 Hollenback 1213-H4 Asa60 MV1213-H4 Asa Light MV</p>
--	---	--	--	--	--	--	--	--	--	--



AMALGAM FILLING INSTRUMENTS

Markley

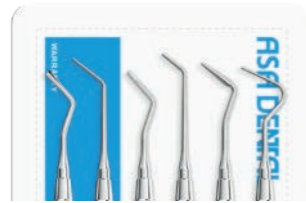
Set of 6

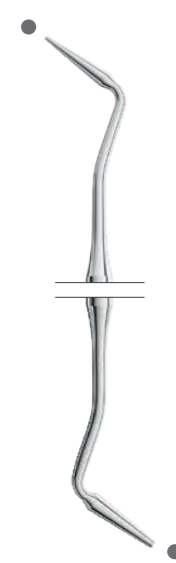
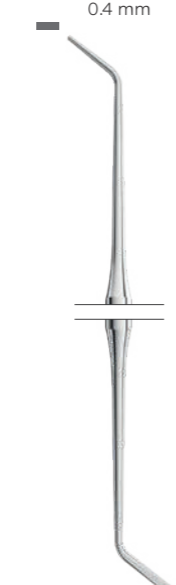

Model	Set Code	Handle
1 · 2 · 3 · 4 · 5 · 6	S1400	Asa60
1 · 2 · 3 · 4 · 5 · 6	SMV1400	Asa Light MV

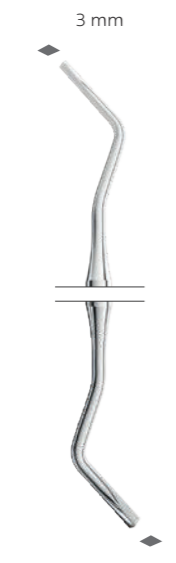
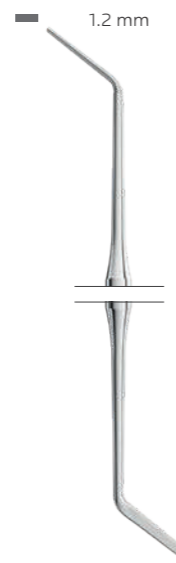
0.4 mm  0.6 mm 1 Markley 1400-1 Asa60 MV1400-1 Asa Light MV	0.5 mm  1 mm 2 Markley 1400-2 Asa60 MV1400-2 Asa Light MV	0.4 mm  1.2 mm 3 Markley 1400-3 Asa60 MV1400-3 Asa Light MV	3 mm  1.6 mm 6 Markley 1400-6 Asa60 MV1400-6 Asa Light MV
 3 mm 4 Markley 1400-4 Asa60 MV1400-4 Asa Light MV	 1.2 mm 5 Markley 1400-5 Asa60 MV1400-5 Asa Light MV		

AMALGAM FILLING INSTRUMENTS

Foc

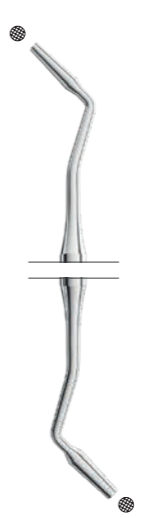
 0 Foc ML1401-0/WML1401-0 Leonardo ML 1401-0 Asa60	serrated  0S Foc 1401-0S Asa60 ML1401-0S Leonardo ML	serrated  1 Foc 1401-1 Asa60 ML1401-1 Leonardo ML	serrated  1S Foc 1401-1S Asa60 ML1401-1S Leonardo ML	 2 Foc 1401-2 Asa60 ML1401-2 Leonardo ML	serrated  2S Foc 1401-2S Asa60 ML1401-2S Leonardo ML
--	--	---	--	---	---

FILLING INSTRUMENTS

Burnishers

2.2 mm	2.8 mm	1.2 mm	1 mm	1.4 mm	2 mm
					
	3.2 mm 2 Westcott 1204-2 Asa60 MV1204-2 Asa Light MV	2 mm 2 Ladmore 1214-2 Asa60 MV1214-2 Asa Light MV	1.8 mm 3 Ladmore 1214-3 Asa60 MV1214-3 Asa Light MV	2.5 mm 18 Ball 1215-18 Asa60 MV1215-18 Asa Light MV RC1215-18 ● AsaWave RC	1 mm 26-27S Ball 1215-27S Asa60 MV1215-27S Asa Light MV RC1215-27S ● AsaWave RC
	1.6 mm		3.4 mm		
					
2.5 mm 1 Westcott 1204-1 Asa60 MV1204-1 Asa Light MV	3 mm 27-29 Ball 1215-29 Asa60 MV1215-29 Asa Light MV	1.3 mm A 1214-A Asa60	W3 1215-W3 Asa60	NYU/B2 1220-B2 Asa60 MV1220-B2 Asa Light MV	2/31 1221-31 Asa60 MV1221-31 Asa Light MV

PLASTIC FILLING INSTRUMENTS

with titanium nitride-coated tips

1 mm	1.6 mm	2 mm	2 mm	2.9 mm
				
1.2 mm 1 1208T-1 Asa60	2 mm 2 1208T-2 Asa60	2.6 mm 3 1208T-3 Asa60	0.1 mm 2 1209T-2 Asa60	0.4 mm 2 1210T-2 Asa60

PLASTIC FILLING INSTRUMENTS

1.2 mm	1.6 mm	1.2 mm	1.6 mm	1 mm	2.5 mm
					
	0.1 mm	2.2 mm	2.7 mm	2 mm	
	2 1206-2 Asa60 MV1206-2 Asa Light MV	1 1207-1 Asa60 MV1207-1 Asa Light MV	2 1207-2 Asa60 MV1207-2 Asa Light MV	1 1208-1 Asa60 MV1208-1 Asa Light MV	
	0.7 mm	2.5 mm	1 mm	2 mm	
					
0.1 mm	2.5 mm	3 mm	0.1 mm	0.1 mm	0.1 mm
1 1206-1 Asa60 MV1206-1 Asa Light MV	2 1208-2 Asa60 MV1208-2 Asa Light MV	3 1208-3 Asa60 MV1208-3 Asa Light MV	1 1209-1 Asa60 MV1209-1 Asa Light MV	2 1209-2 Asa60 MV1209-2 Asa Light MV	3 1209-3 Asa60 MV1209-3 Asa Light MV

PLASTIC FILLING INSTRUMENTS

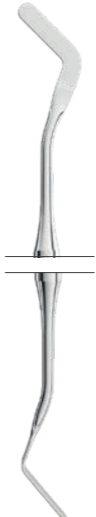
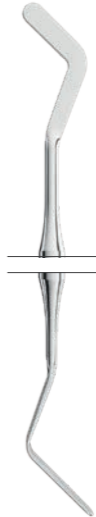
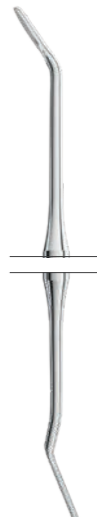
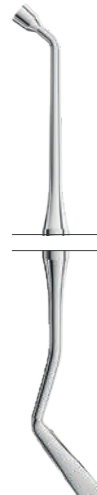
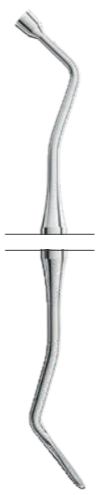
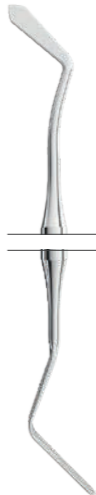
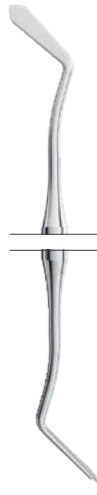
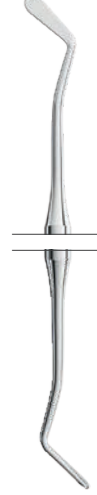
				
	2 1210-2 Asa60 MV1210-2 Asa Light MV RC1210-2 ● AsaWave RC	3 1210-3 Asa60 MV1210-3 Asa Light MV RC1210-3 ● AsaWave RC	1 Woodson 1216-1 Asa60 MV1216-1 Asa Light MV	2 Woodson 1216-2 Asa60 MV1216-2 Asa Light MV
				
1 1210-1 Asa60 MV1210-1 Asa Light MV RC1210-1 ● AsaWave RC	3 Woodson 1216-3 Asa60 MV1216-3 Asa Light MV	11 1217-11 Asa60 MV1217-11 Asa Light MV	6 1218-6 Asa60 MV1218-6 Asa Light MV	179 1219-179 Asa60 MV1219-179 Asa Light MV

MODELING INSTRUMENTS

MODELING INSTRUMENTS



1/2 Hollenback
1500-02
Asa60
MV1500-02
Asa Light MV

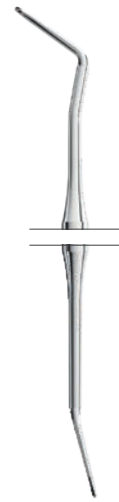

1 Ward
1501-1
Asa60
MV1501-1
Asa Light MV

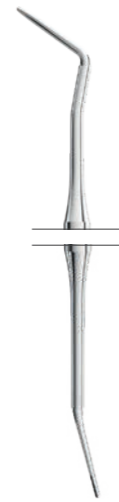

1S Ward
1501-1S
Asa60
MV1501-1S
Asa Light MV



3S Hollenback
1500-3S
Asa60
MV1500-3S
Asa Light MV



2 Ward
1501-2
Asa60
MV1501-2
Asa Light MV

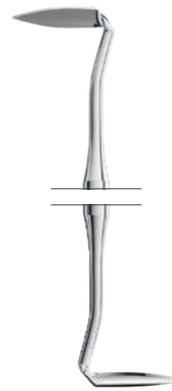

3 Hollenback
1500-3
Asa60
MV1500-3
Asa Light MV



1 Frahm
1502-1
Asa60
MV1502-1
Asa Light MV

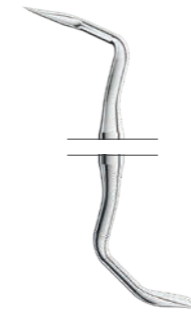

2 USC
1503-2
Asa60

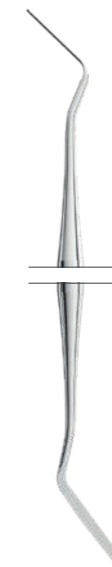

1 Interproximal
1504-1
Asa60



2 Interproximal off-angle
1504-2
Asa60



SHO-A
1505-A
Asa60

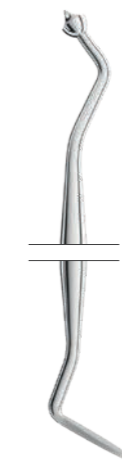

3-SHO
1505-3
Asa60



104
1506-104
Asa60



8 Wiland
1507-8
Asa60
MV1507-8
Asa Light MV

MODELING INSTRUMENTS

Instruments for retraction cords



1	2	3	4
cleoid-discoïd	cleoid-discoïd	cleoid-discoïd	cleoid-discoïd
1600-1	1600-2	1600-3	1600-4
Asa60	Asa60	Asa60	Asa60
MV1600-1	MV1600-2	MV1600-3	MV1600-4
Asa Light MV	Asa Light MV	Asa Light MV	Asa Light MV



1	2
1310-1	1310-2
Asa60	Asa60

OPERATIVE INSTRUMENTS

Instrument for the application of tinctures and medicaments



Orban Loop
1303
Octagonal

Placement instruments



1300	1301	1302
Asa35	Asa60	Asa60
	MV1301	MV1302
	Asa Light MV	Asa Light MV

Gauze packers



1	2
Luniatschek	Luniatschek
2 mm	3 mm
1355-1	1355-2
Octagonal	Octagonal

CROWN INSTRUMENTS

Crown remover
complete with double-ended tips

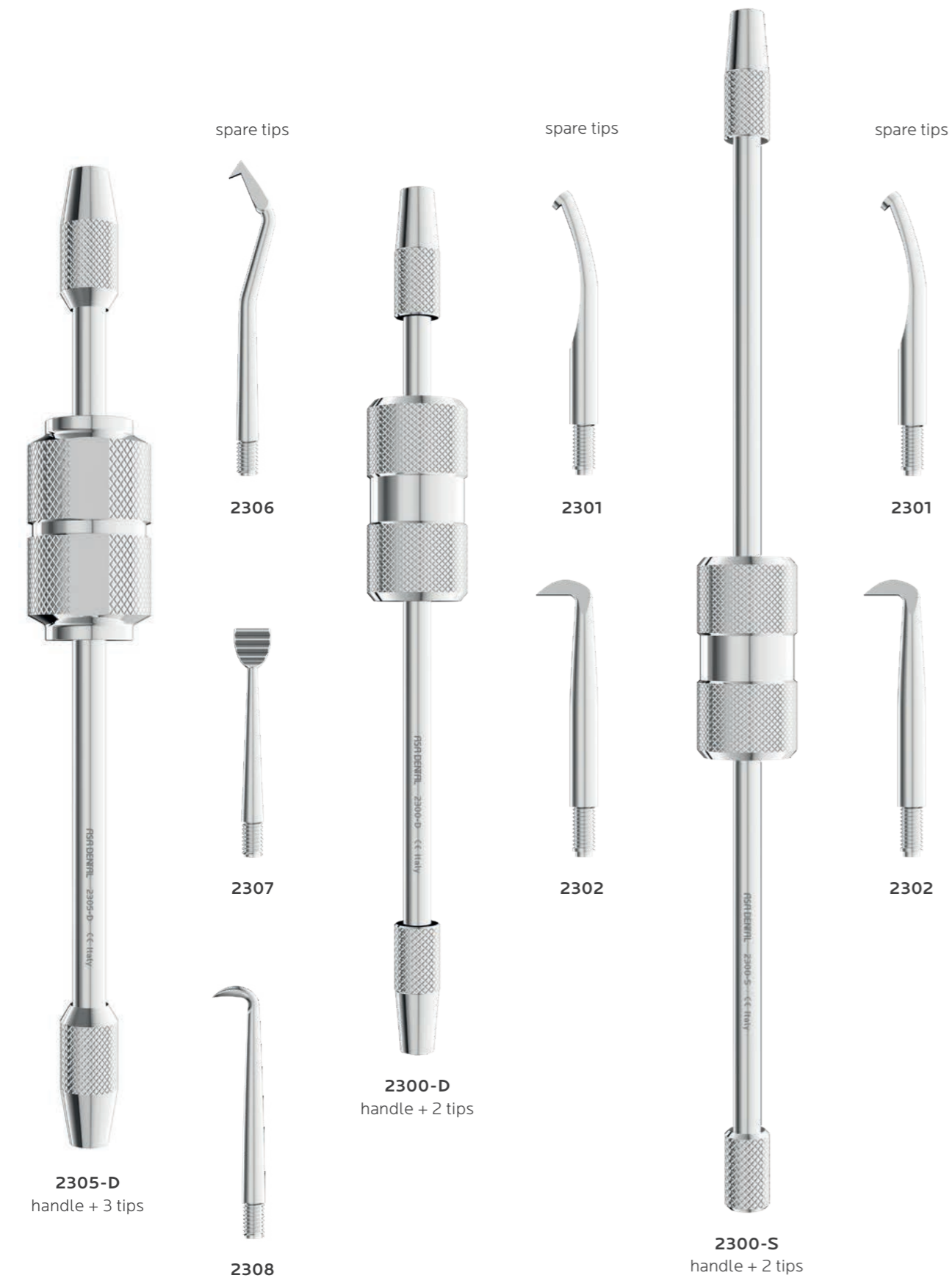

Crown remover
complete with single-ended tips

CROWN INSTRUMENTS
Crown removers and spreaders



CROWN INSTRUMENTS
Decimal calipers

Articulating paper forceps

CROWN INSTRUMENTS
Telescopic crown pliers

Copper ring removing pliers

measuring range: 0-10 mm
(indicative measures)



**Iwanson
for wax
2550-1**

measuring range: 0-100 mm
(indicative measures)

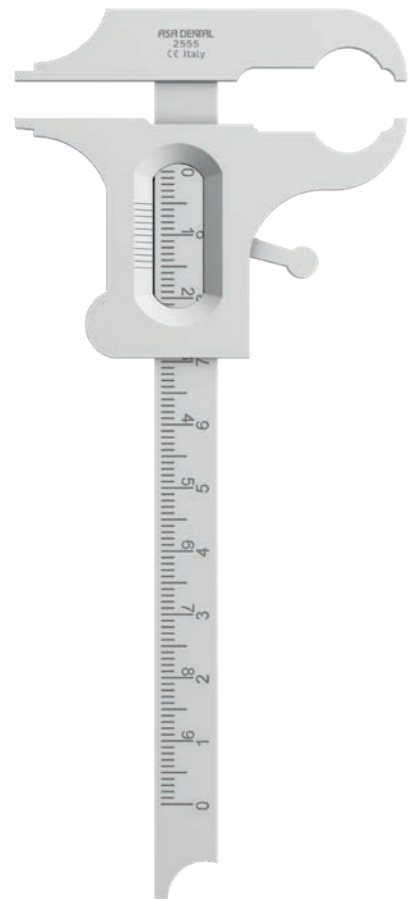

**Boley
14 cm
2555**

measuring range: 0-10 mm
(indicative measures)



**Iwanson
for metal
2550-2**



**Miller
15 cm
0670**

**15 cm
0671**

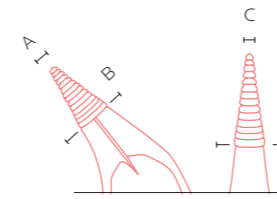

A	4.4 mm
B	5.0 mm
C	3.4 mm
D	3.8 mm

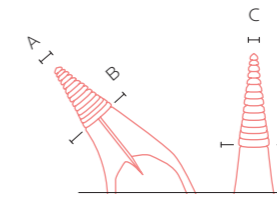

A	3.3 mm
B	4.0 mm
C	2.3 mm
D	3.0 mm



**Böhm
14.5 cm
2500-2**



**Böhm
11.5 cm
2500-1**



**Furrer
straight
16 cm
2331-1**



**Furrer
curved
16 cm
2331-2**

HEMOSTATS



1 Halstead-Mosquito
straight
12 cm
0500-1



1 Micro-Mosquito
straight
10 cm
0501-1



1 Kelly
straight
14 cm
0510-1

SCISSORS
for gold leaf



1
straight
12 cm
0300-1

UNIVERSAL SCISSORS
with tungsten carbide blades

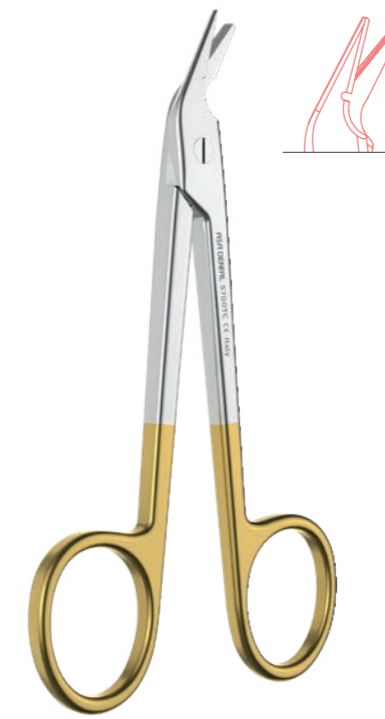

TC Universal
12 cm
5700TC

UNIVERSAL SCISSORS
one serrated blade



Universal
12 cm
5700

CROWN SCISSORS



1
straight
one serrated blade
10.5 cm
5600-1



2
curved
one serrated blade
10.5 cm
5600-2



1
straight
10.5 cm
5601-1

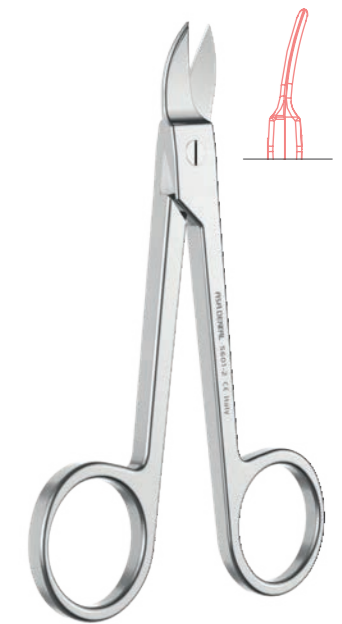

2
curved
10.5 cm
5601-2

MATRIX RETAINERS

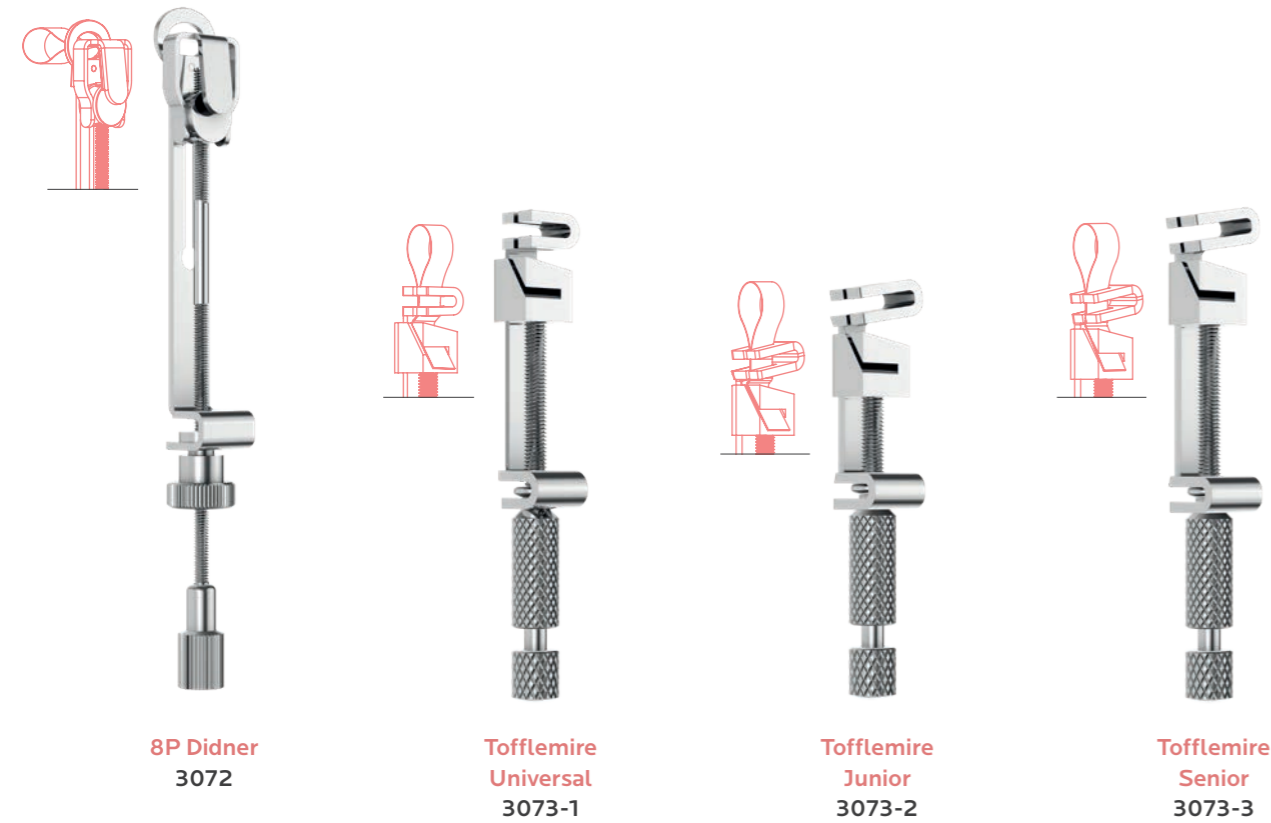
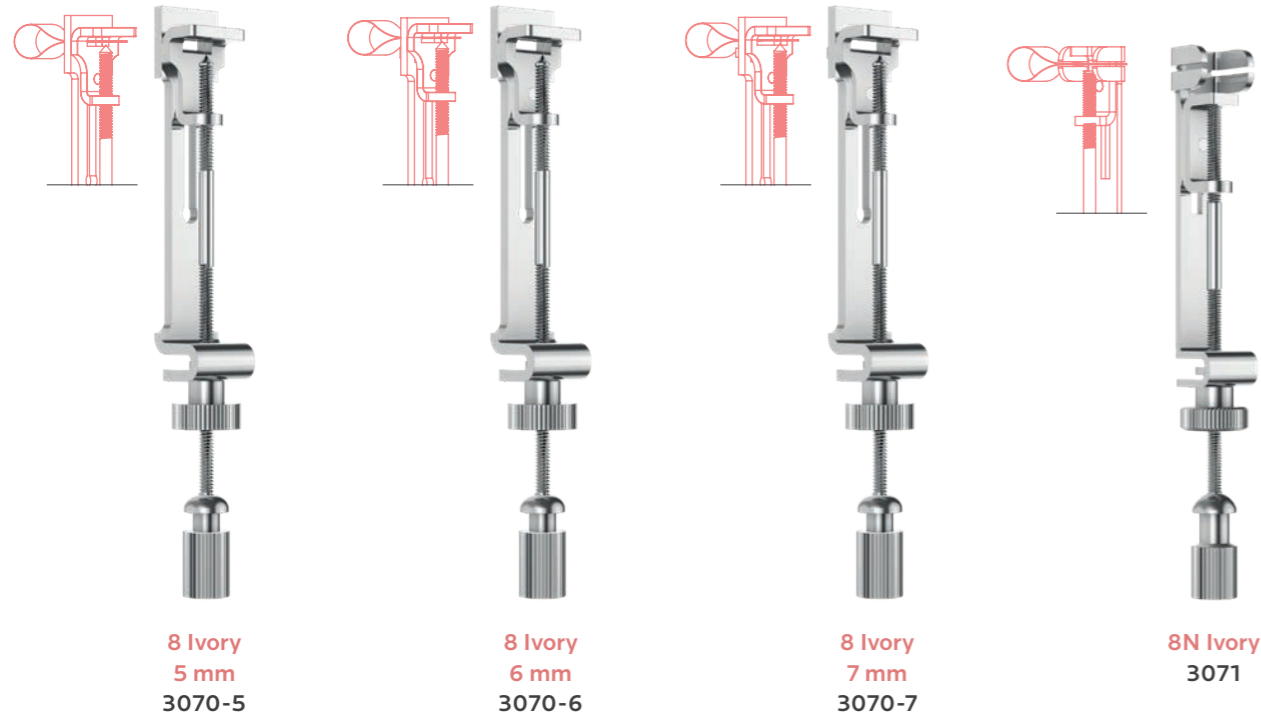

MATRICES
strip

for matrix retainers

- 3070-5
- 3071
- 3072
- 3073-1
- 3073-2
- 3073-3

for matrix retainers

- 3070-6
- 3070-7
- 3071
- 3072
- 3073-1
- 3073-2
- 3073-3

for matrix retainers

- 3070-7
- 3071
- 3072
- 3073-1
- 3073-2
- 3073-3



5 mm x 100 cm
3082-5



6 mm x 100 cm
3082-6



7 mm x 100 cm
3082-7

Tofflemire
12 pcs / pack

12 pcs / pack
assorted:



1
Tofflemire
3081-1



2
Tofflemire
3081-2



3
Tofflemire
3081-3

- 3081-1
- 3081-2
- 3081-3



Tofflemire
3081

COMPOSITE INSTRUMENTS

Molars and Pre-molars

Molars, Pre-molars, Incisors and Canines



Asa Com 1/1B
5112-3
Asa60

Asa Com 2/2B
0704-16D2
Asa60

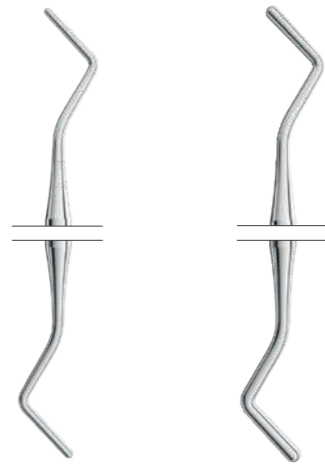

Asa Com 3/3B
1203-1
Asa60

Asa Com 4/4B
1203-3
Asa60

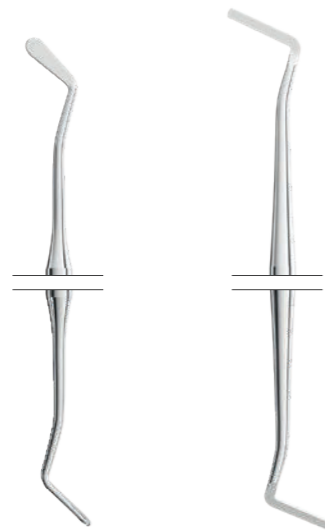

Asa Com 5/5B
1219-179
Asa60

Asa Com 6/6B
1504-2
Asa60

Asa Com 1/1B
two tips in the same shape but different sizes, for filling and modeling occlusal anatomy in premolars and molars
Universal

Asa Com 2/2B
same tip but with two different angles to model occlusal ridges in premolars and molars
Universal

Asa Com 3/3B
highly versatile condenser with small and large semi-spherical tip, for placement and contouring valid for: classes 1, 2, 3, 4 and 5

Asa Com 4/4B
highly versatile filling instrument with different size semi-spherical tips, for placement and contouring; can be used for: classes 1, 2, 3, 4 and 5

Asa Com 5/5B
versatile instrument for the application, layering and modeling of composite, with opposite (lateral and frontal) blades; can be used for: classes 1, 2, 3, 4 and 5

Asa Com 6/6B
filling and shaping instrument ideal for use in mesial and distal areas; can be used for: classes 2, 3 and 5

COMPOSITE INSTRUMENTS

Molars, Pre-molars, Incisors and Canines

Molars and Pre-molars



Asa Com 7/7B
5153-1
● Alu80

Asa Com 8/8B
1220-B2
Asa60

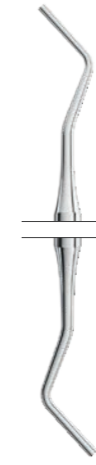

Asa Com 9/9B
1201-1L
Asa60

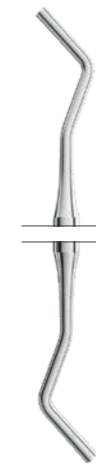

Asa Com 10/10B
1201-2L
Asa60

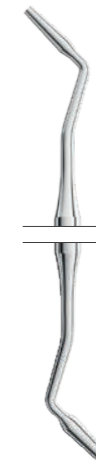

Asa Com 11/11B
1401-1
Asa60

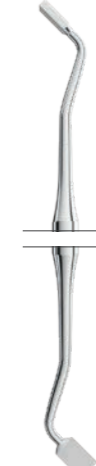

Asa Com 12/12B
1213-H3
Asa60

Asa Com 7/7B
versatile instrument ideal for gingival areas but also suitable for mesial and distal definition; can be used for: classes 1, 2, 3, 4 and 5

Asa Com 8/8B
instrument that combines a small tip for occlusal anatomy modeling and a narrow paddle for anterior areas
Universal

Asa Com 9/9B
condenser equipped with 2 different-size flat tips that can be used for: classes 1, 2, 3, 4 and 5

Asa Com 10/10B
condenser equipped with 2 different-size flat tips that can be used for: classes 1, 2, 3, 4 and 5

Asa Com 11/11B
small and large tip conical condenser
Universal

Asa Com 12/12B
universal condenser with opposite (lateral and frontal) tips
Universal

COMPOSITE INSTRUMENTS

Molars, Pre-molars, Incisors and Canines



Asa Com 13/13B
5112-4
Asa60

Asa Com 15/15B
210-3
Asa60
MV1210-3
Asa Light MV
RC1210-3
● AsaWave RC

Asa Com 14/14B
1210-1
Asa60
MV1210-1
Asa Light MV
RC1210-1
● AsaWave RC

Asa Com 13/13B
instrument with opposite blades for composite contouring, removal and modeling
Universal

Asa Com 14/14B
versatile instrument for composite application, layering and modeling, with opposite (lateral and frontal) tips
Universal

Asa Com 15/15B
versatile instrument for composite application, layering and modeling, with opposite (lateral and frontal) tips; can be used for: classes 2, 3, 4 and 5

AsaWave composite instruments

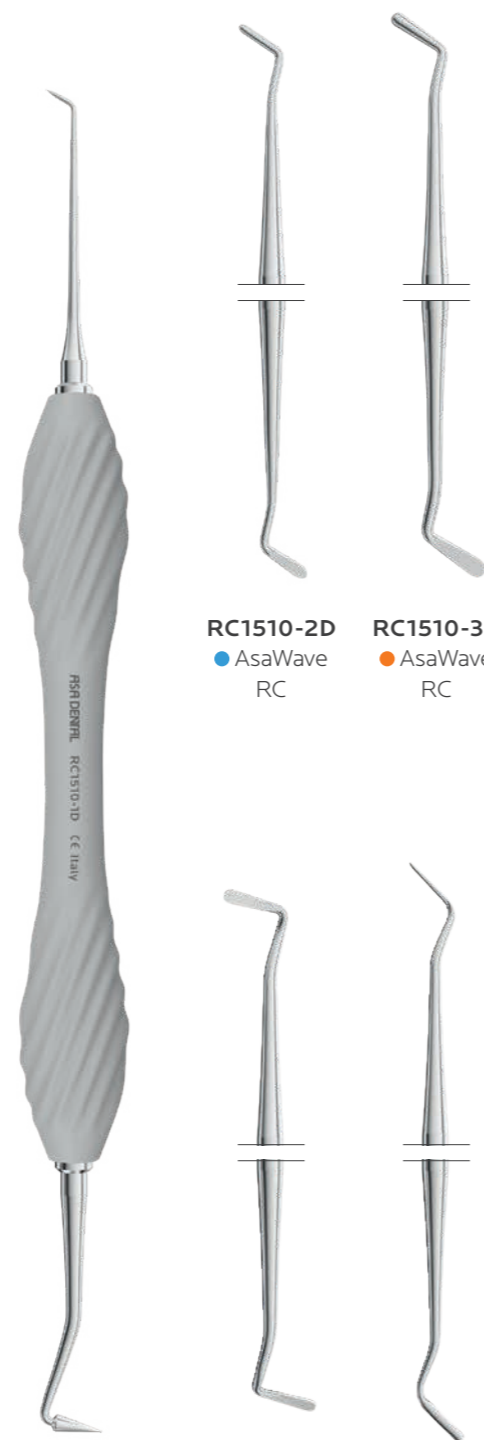

RC1510-1D
● AsaWave RC

RC1510-4D
● AsaWave RC

RC1510-5D
● AsaWave RC

RC1510-2D
● AsaWave RC

RC1510-3D
● AsaWave RC

COMPOSITE INSTRUMENTS



S1222-7

Asa Com 1/1B	5112-3
Asa Com 2/2B	0704-16D2
Asa Com 3/3B	1203-1
Asa Com 4/4B	1203-3
Asa Com 5/5B	1219-179
Asa Com 6/6B	1504-2
Asa Com 7/7B	5153-1



S1222-15

Asa Com 1/1B	5112-3
Asa Com 2/2B	0704-16D2
Asa Com 3/3B	1203-1
Asa Com 4/4B	1203-3
Asa Com 5/5B	1219-179
Asa Com 6/6B	1504-2
Asa Com 7/7B	5153-1
Asa Com 8/8B	1220-B2
Asa Com 9/9B	1201-1L
Asa Com 10/10B	1201-2L
Asa Com 11/11B	1401-1
Asa Com 12/12B	1213-H3
Asa Com 13/13B	5112-4
Asa Com 14/14B	1210-1
Asa Com 15/15B	1210-3

ENDODONTICS

MADE IN ITALY

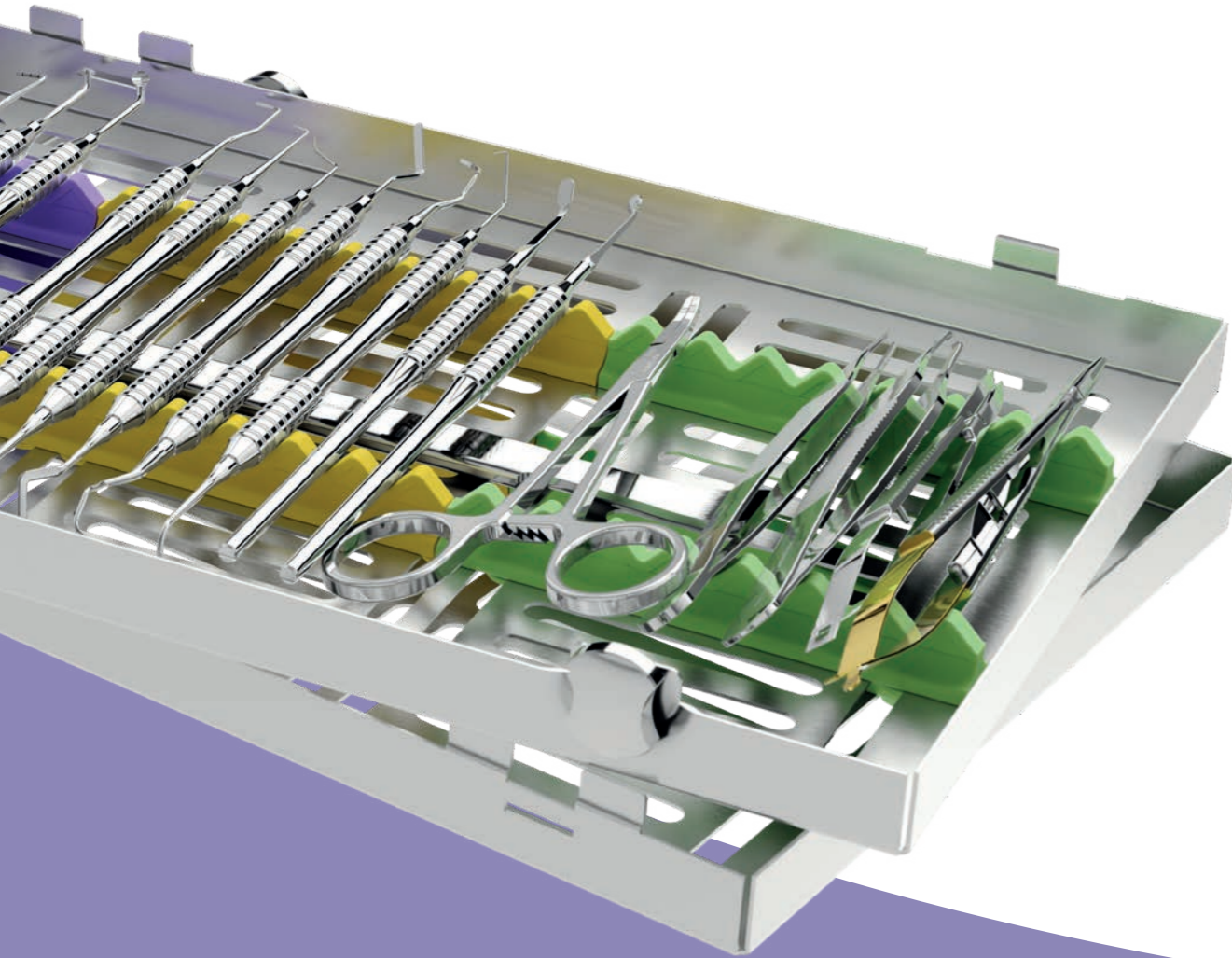

G2	Endodontic instruments
G4	Root canal spreaders
G5	Root canal pluggers
G7	Vertical condensers
G8	Apical Essential
G12	Apical Full

PRECISION AND SAFETY WITH LEADING-EDGE INSTRUMENTS

Endodontics is an essential branch of dentistry, focusing on the diagnosis, prevention and treatment of diseases of dental pulp and periradicular tissues. Its primary goal is to preserve and maintain natural teeth.

Asa Dental stands out in this field by offering a complete range of high-quality endodontic instruments that are designed to ensure precise, minimally invasive procedures. Among our many innovative products, two kits that are specifically designed for endodontic microsurgery stand out. They provide professionals with cutting-edge instruments with which to successfully deal with the most complicated clinical cases, thereby guaranteeing optimal results and maximum patient safety.

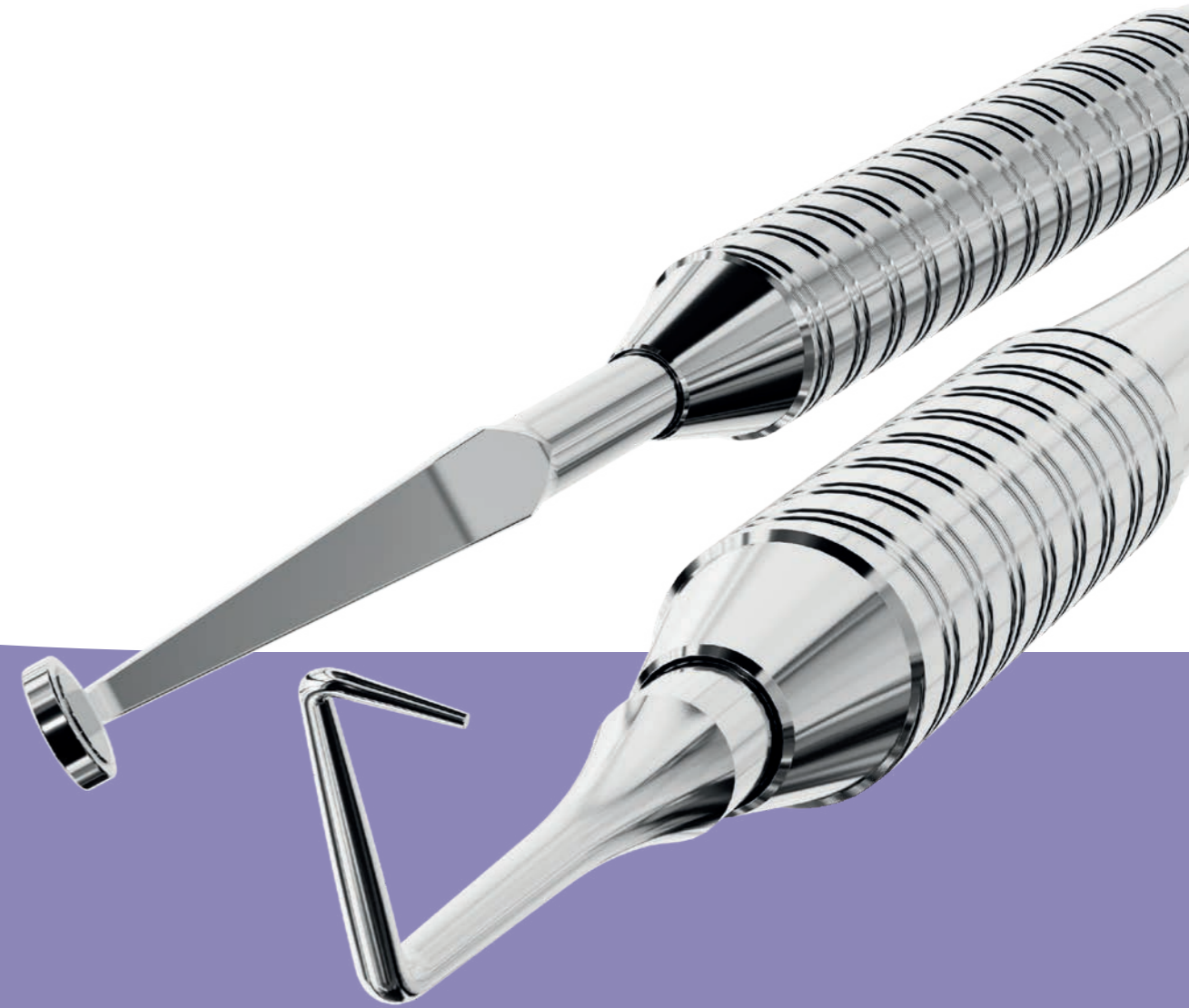

ENDODONTIC INSTRUMENTS

Pliers for removing broken broaches



1
13 cm
0870-1



2
13 cm
0870-2

ENDODONTIC INSTRUMENTS

Forceps and pliers for silver cones

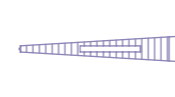

1 Stieglitz
0102-1

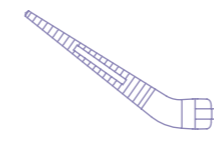
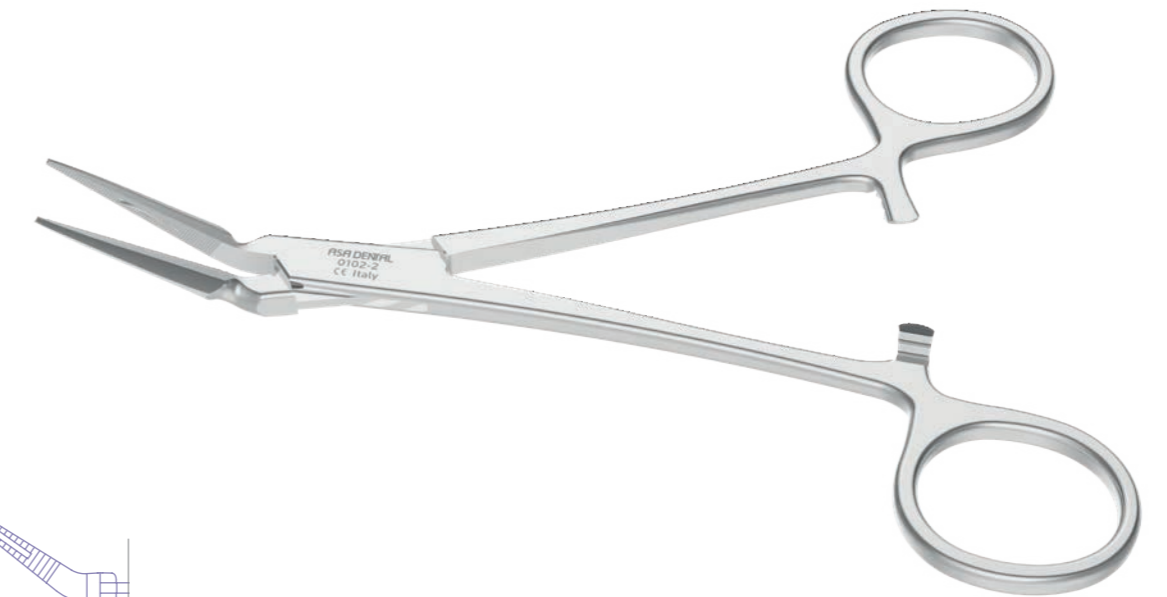

2 Stieglitz
0102-2

ROOT CANAL SPREADERS

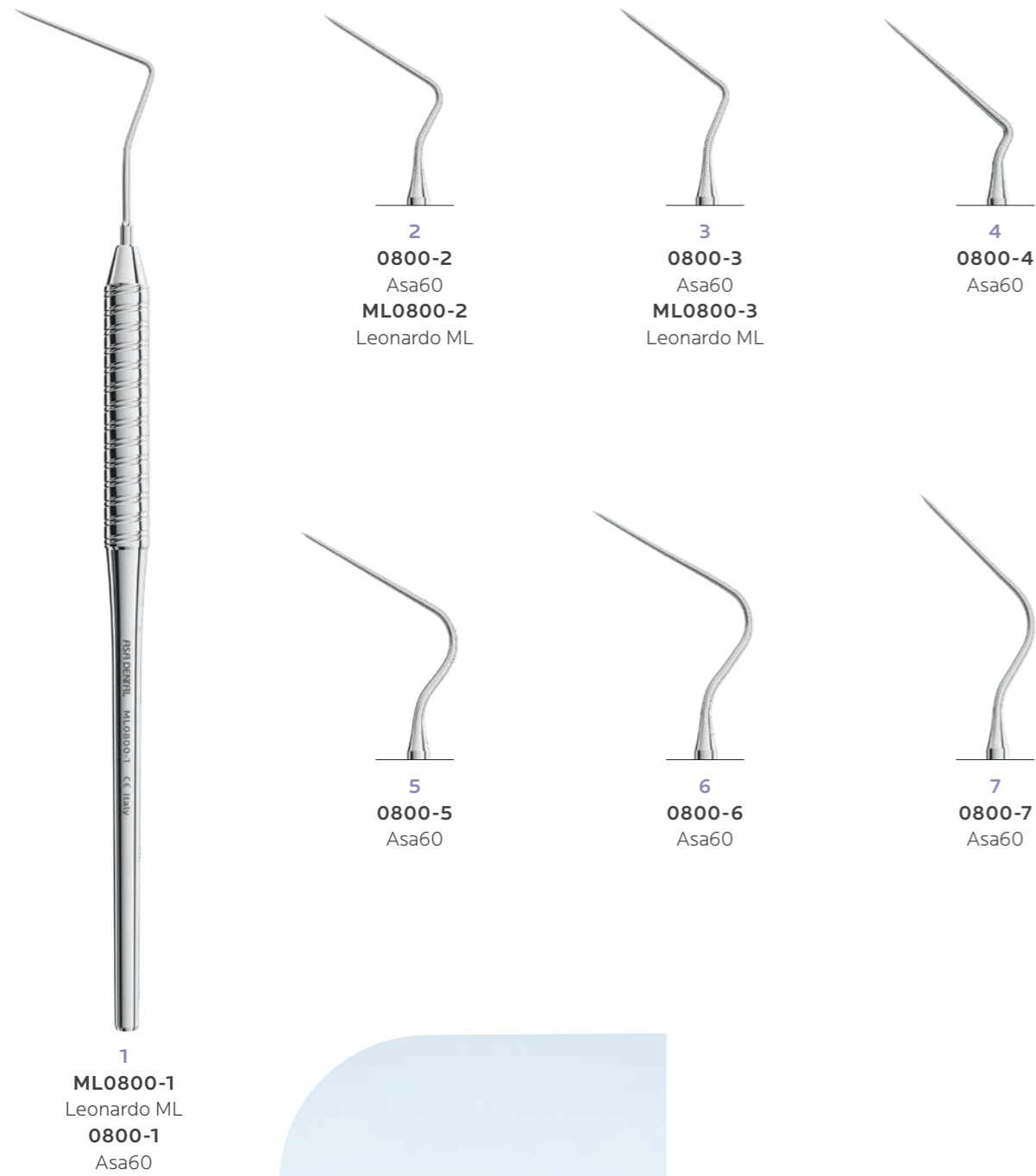

0800-1
Root canal instruments

A special coating helps tips work without any adherence issue in any condition, including those asking for extra pressure.

ROOT CANAL PLUGGERS

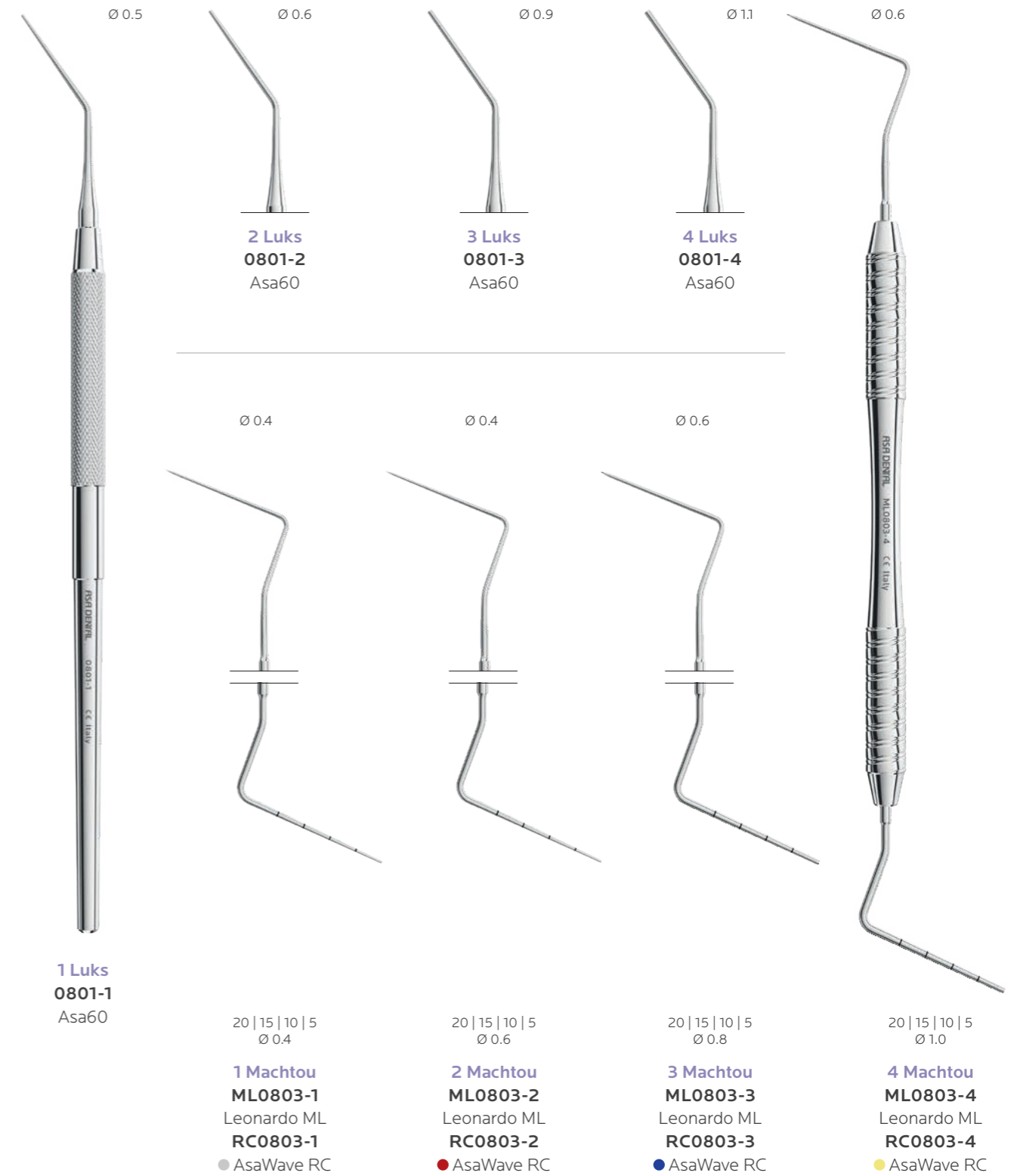

ROOT CANAL PLUGGERS



VERTICAL CONDENSERS



ENDODONTIC RULER

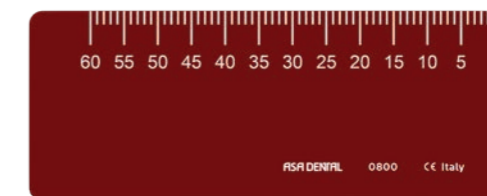

0800

APICAL

Micro Endo Surgery Kits

APICAL ESSENTIAL

A selection of instruments designed and produced exclusively by Asa Dental and completed by micro mirrors.

SML2021FP	Apical micro endo kit - Essential	
ML0805-1	plugger PIR1	1
ML1222-1	plugger PIR2	2
ML1222-2	plugger PIR3	2
ML2017-1	bone curette FAR1	1
ML2017-2	bone curette FAR2	2
2240-1	micro mouth mirror, single, 3 mm	1
ML2101	mouth mirror handle	
2771-1L	locking tray for 10 instruments (lilac)	



APICAL Essential
SML2021FP

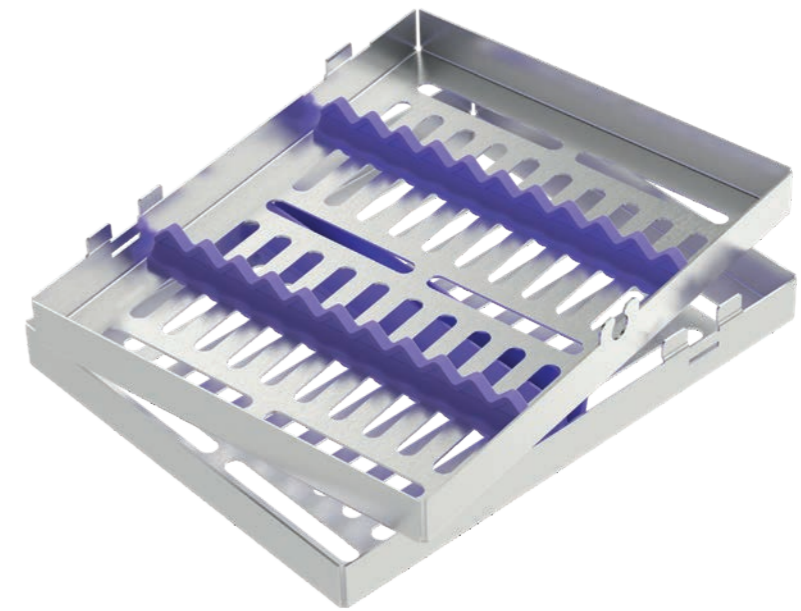

Locking tray for 10 instruments
(lilac)
2771-1L

APICAL ESSENTIAL

A selection of instruments designed and produced exclusively by Asa Dental and completed by micro mirrors.



Plugger PIR1
ML0805-1



Plugger PIR2
ML1222-1



Plugger PIR3
ML1222-2



Bone curette FAR1
ML2017-1



Bone curette FAR2
ML2017-2



Micro mouth mirror, single, 3 mm
2240-1



Mouth mirror handle
ML2101

APICAL

Micro Endo Surgery Kits

APICAL FULL

A complete selection of instruments to perform any type of micro surgery.

SML2021CF	Apical micro endo kit - Full	
ML0805-1	plugger PIR1	1
ML1222-1	plugger PIR2	2
ML1222-2	plugger PIR3	2
ML2017-1	bone curette FAR1	1
ML2017-2	bone curette FAR2	2
ML2101 x2	mouth mirror handle	
2240-1	micro mouth mirror, single, 3 mm	1
2241-5	micro mouth mirror, single, 3x6 mm	5
1855-23	Seldin retractor	23
0365-1	micro blade handle	
0702L-15	perio pocket probe	15
ML1807-14	Gracey Fig. 13/14	13/14
ML1807-02	Gracey Fig. 1/2	1/2
0622-1	tissue pliers, 12 cm, Fig. 1 Micro-Adson 1x2	1
0624-1	tissue pliers, 12 cm, Fig. 1 Micro-Adson	
ML1102-1	Heidemann anatomic handle Fig. 1	1
0445TH-14TC	Castroviejo TC needle holder, 14 cm (straight, fine tip)	
0500-2	Halstead-Mosquito hemostat, 12 cm (curved)	2
0312-1	Westcott scissors, 11 cm (sharp points)	1
2770-1MX	locking tray for 20 instruments (lilac, yellow, green)	

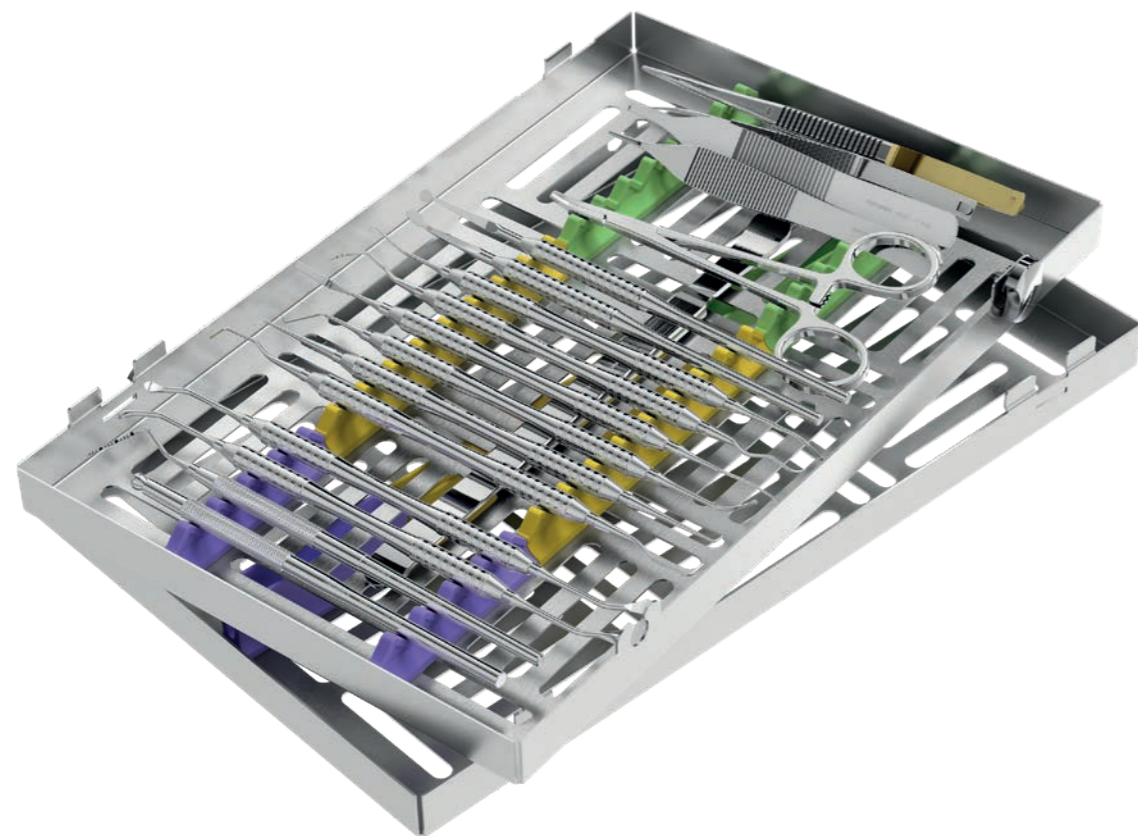

APICAL Full
SML2021CF

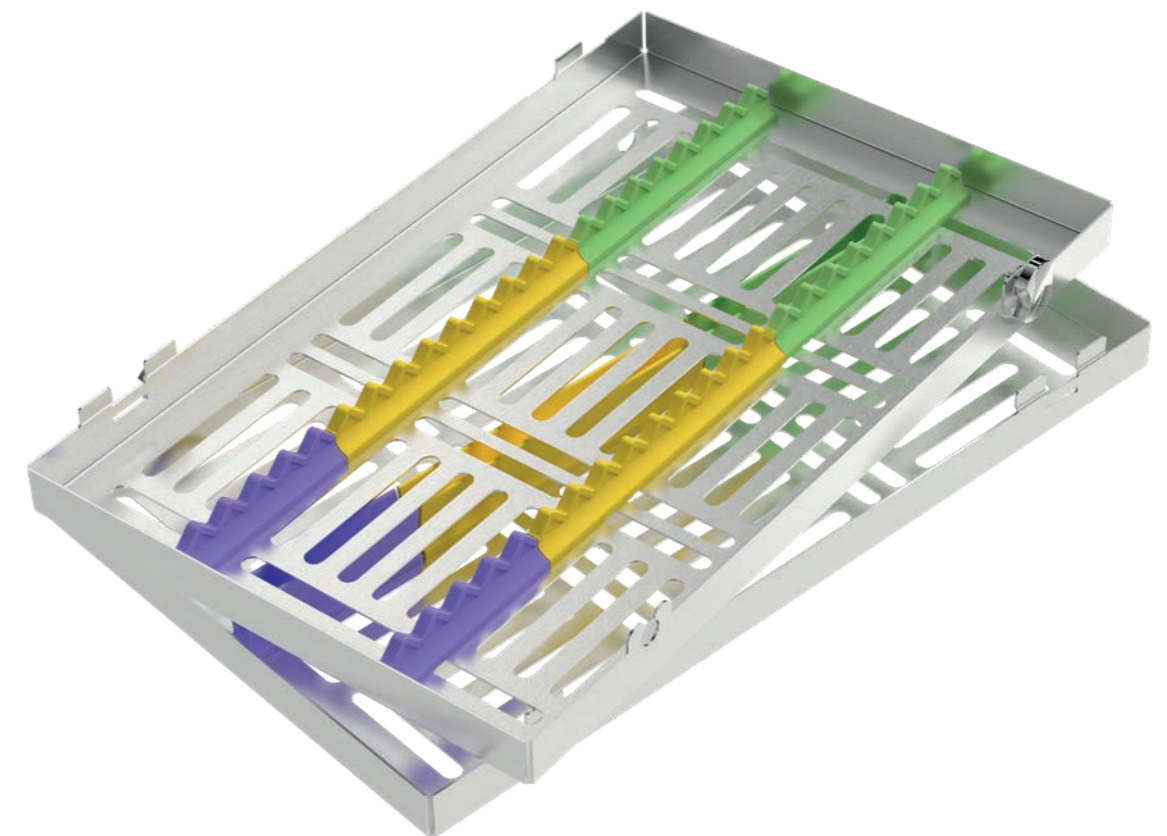

Locking tray for 20 instruments
(lilac, yellow, green)
2770-1MX

APICAL FULL

A complete selection of instruments to perform any type of micro surgery.



Plugger PIR1
ML0805-1



Plugger PIR2
ML1222-1



Plugger PIR3
ML1222-2



Bone curette FAR1
ML2017-1



Bone curette FAR2
ML2017-2



Micro mouth mirror, single, 3 mm
2240-1



Mouth mirror handle
ML2101

APICAL FULL

A complete selection of instruments to perform any type of micro surgery.



Micro mouth mirror, single, 3x6 mm
2241-5



Mouth mirror handle
ML2101



Seldin retractor
1855-23



Micro blade handle
0365-1



Perio pocket probe
0702L-15



Gracey Fig. 13/14
ML1807-14



Gracey Fig. 1/2
ML1807-02

APICAL FULL

A complete selection of instruments to perform any type of micro surgery.

APICAL FULL

A complete selection of instruments to perform any type of micro surgery.



Tissue pliers, 12 cm,
Fig. 1 Micro-Adson 1x2
0622-1



Tissue pliers, 12 cm,
Fig. 1 Micro-Adson
0624-1



Heidemann anatomic handle
Fig. 1
ML1102-1



Needle holder cm. 14 Castroviejo TC
(straight, fine tip)
0445TH-14TC



Halstead-Mosquito hemostat, 12 cm
(curved)
0500-2



Westcott scissors, 11 cm
(sharp points)
0312-1

APICAL FULL

A complete selection of instruments to perform any type of micro surgery.

PERIODONTAL

MADE IN ITALY

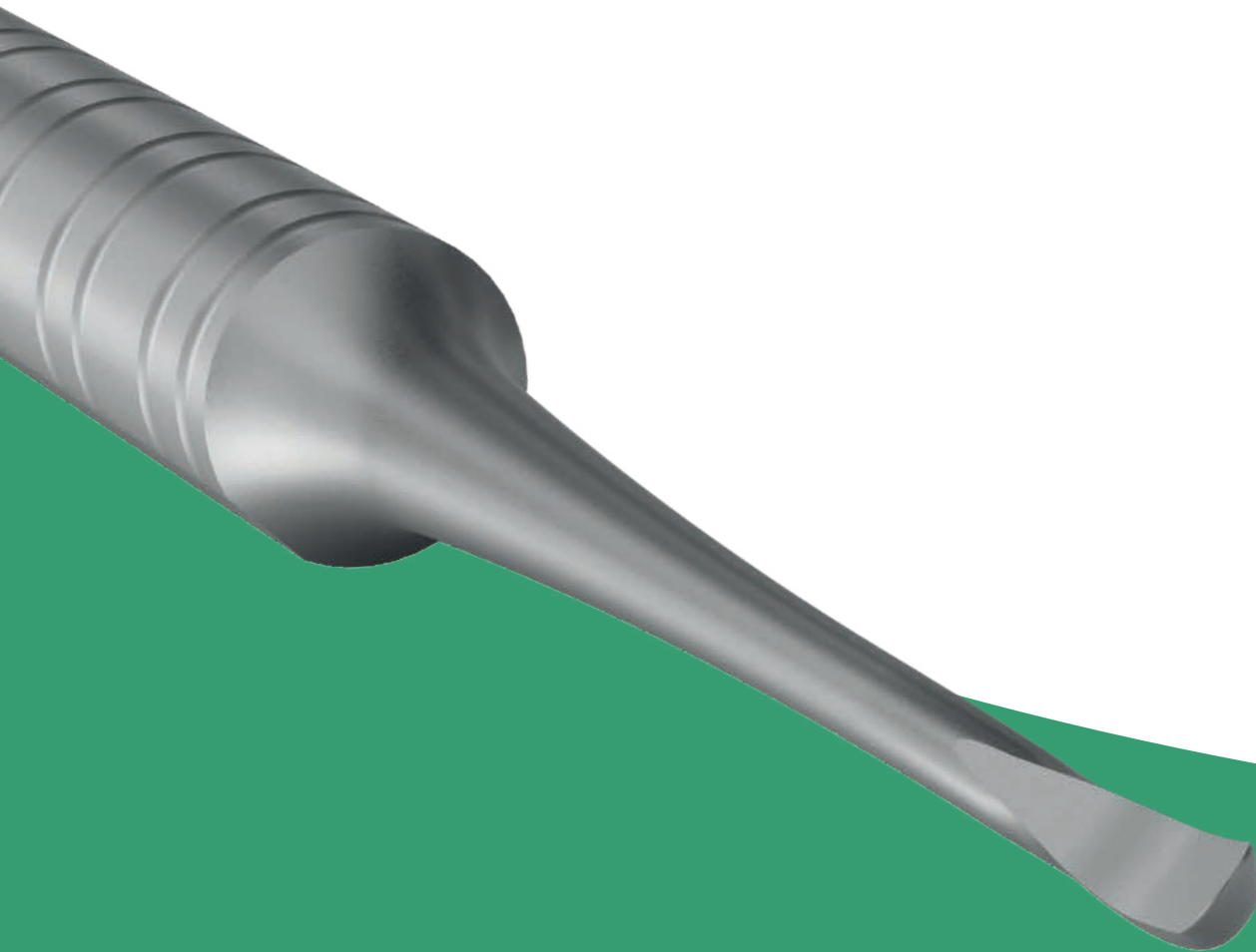

OPTIMIZING TIME, ENHANCING CUSTOMER SATISFACTION

At Asa Dental we know that there are two things every professional cares the most about: customer satisfaction and time. Hence, manufacturing instruments that guarantee the best results in the shortest amount of time has become our number one motivator. We use cutting-edge technologies to create cutting-edge periodontal instruments, and we explore every possible design to give them the necessary options in terms of shape, handle and size. Sharp, durable and resilient to resist time and use.

H3	Pocket Probes
H4	Curettes and Scalers
H11	Gracey curettes
H14	Scalers
H16	Periosteals and Elevators
H20	Bone curettes
H22	Files
H24	Gingivectomy knives
H26	Chisels and Gouges
H29	Surgical mallets
H30	Periodontal instruments
H31	Pocket markers
H32	Grinding stones
H34	Kits

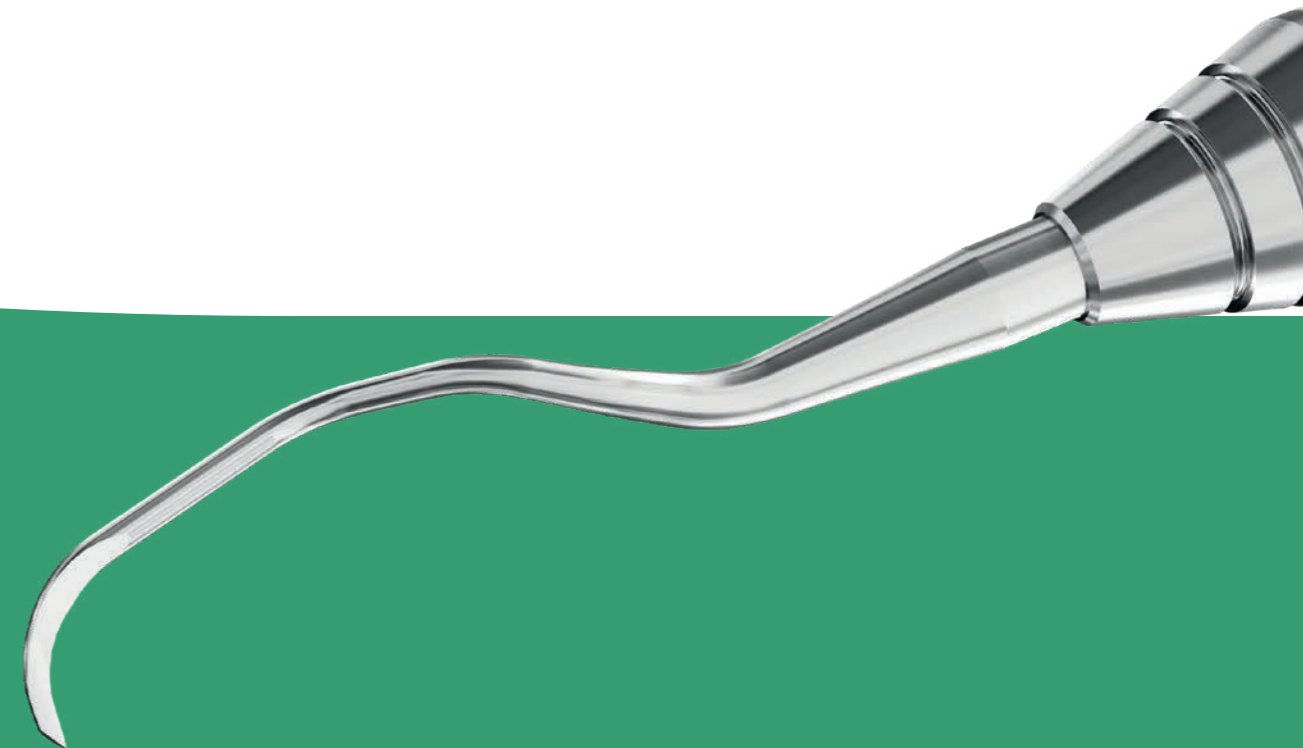

HANDLE

SINGLE-ENDED

- Asa35**
(stainless steel)
ø 3.5 mm
- Asa60**
(stainless steel)
ø 6.0 mm
- Leonardo ML**
(stainless steel)
ø 7.0 mm
- **AsaWave RC**
(plastic resin in PPSU
with a steel core)
ø 7.5 / 14.5 mm



DOUBLE-ENDED

- Asa60**
(stainless steel)
ø 6.0 mm
- Asa Light MV**
(stainless steel, hollow)
ø 8.0 mm
- Leonardo ML**
(stainless steel)
ø 7.0 mm
- Leonardo Light LV**
(stainless steel)
ø 10.0 mm
- Ottagonale**
(stainless steel)
ø 5.5 mm
- Perfection**
(stainless steel)
ø 8.0 mm
- **AsaWave RC**
(plastic resin in PPSU
with a steel core)
ø 7.5 / 14.5 mm

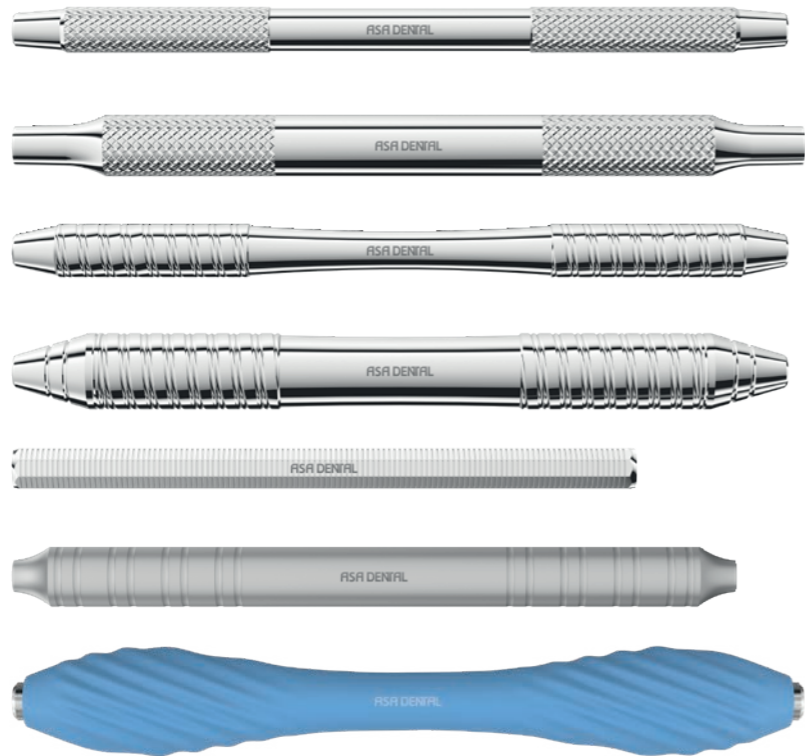

HOW TO USE THE INFORMATION

- **CP-12** model + scientific name
- **RC0702-12** Asa Dental code
- **AsaWave RC** handle option

ASA WAVE: THE NEW ASA DENTAL HANDLE

Maximum ergonomics, absolute control. The new Asa Dental resin handle is designed to deliver an uncompromising experience. Made from PPSU (Polyphenylsulfone), a high-performance material, it offers exceptional resistance to sterilization and chemicals, maintaining its integrity over time.

Inspired by natural forms, its advanced parametric pattern ensures an optimal grip and precise movements while reducing hand fatigue. A perfect balance of safety and comfort, making it a reliable choice for every procedure.

PERIODONTAL POCKET PROBES



Quick and easy to clean, these periodontal explorers guarantee maximum precision. Depth markings stand up to the most extreme conditions. The ergonomic handle is designed to transform the instrument in the natural extension of your hand.

- New production process
- Laser marking system
- No more peeling paint
- Permanent marking
- Antiglare, low-depth marking
- Tips remain robust and intact

3 6 8 11	3 6 9 12	3.5 5.5 8.5 11.5	1 2 3 4 5 6 7 8 9 10 11 12 13 14 15
CP-11 0702L-11 Asa60	CP-12 0702L-12 Asa60 ● RC0702-12 AsaWave RC	CP-12S 0702L-12S Asa60	CP-15 0702L-15 Asa60
1 2 3 5 7 8 9 10	1 2 3 5 7 8 9 10	1 2 3 5 7 8 9 10	1 2 3 5 7 8 9 10 FLAT TIP
Williams 0703L-1 Asa60	Merrit A 0703L-2 Asa60	Merrit B 0703L-3 Asa60	Goldman-Fox 0703L-4 Asa60
3 6 8	1 2 3 5 7 8 9 10	3.5 6 9 12	1 2 3 5 7 8 9 10 12 14
University of Michigan 0703L-5 Asa60	26 G 0703L-6 Asa60	OMS Novatech ML0702-OMS Leonardo ML	Williams ML0703-14 Leonardo ML ● RC0703-14 AsaWave RC



CP-C
0702-C
Asa35

CURETTES AND SCALERS

Set of 7



Model	Set Code	Handle
02 · 2RL · 4RL · 14 · 412 · 414 · Z	S1806	Asa60
02 · 2RL · 4RL · 14 · 412 · 414 · Z	SMV1806	Asa Light MV

HU 1/2
1806-02
Asa60
MV1806-02
Asa Light MV

2R/2L Columbia
1806-2RL
Asa60
MV1806-2RL
Asa Light MV
ML1806-2RL
Leonardo ML

4R/4L Columbia
1806-4RL
Asa60
MV1806-4RL
Asa Light MV
ML1806-4RL
Leonardo ML

13/14 Columbia
1806-14
Asa60
MV1806-14
Asa Light MV
ML1806-14
Leonardo ML
RC1806-14/
RC1806-14SF
● AsaWave RC

Zerfing-Chisel
1820-Z
Asa60

411/412 Columbia
1806-412
Asa60
MV1806-412
Asa Light MV

413/414 Columbia
1806-414
Asa60
MV1806-414
Asa Light MV

CURETTES AND SCALERS

HU 1/2 Langer
1805-02
Asa60
MV1805-02
Asa Light MV

3/4 Langer
1805-04
Asa60
MV1805-04
Asa Light MV

1 De Marco
1808-1
Asa60

2 De Marco
1808-2
Asa60

1/2 Barnhart
1821-02
Asa60

5/6 Barnhart
1821-06
Asa60

13/14 Indiana University anterior
1824-14
Asa60
MV1824-14
Asa Light MV

17/18 Indiana University posterior
1824-18
Asa60
MV1824-18
Asa Light MV

ME-1 (10/11)
1822-ME1
Asa60

3/4 Rule (23/24)
1823-R04
Asa60

CURETTES AND SCALERS

Set of 7



Model	Set Code	Handle
1 · 2 · 3 · 4 · 5 · 6 · 21	S1809	Asa60
1 · 2 · 3 · 4 · 5 · 6 · 21	SMV1809	Asa Light MV



1 Goldman-Fox
1809-1
Asa60
MV1809-1
Asa Light MV
ML1809-1
Leonardo ML

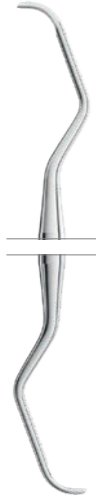

2 Goldman-Fox
1809-2
Asa60
MV1809-2
Asa Light MV
ML1809-2
Leonardo ML

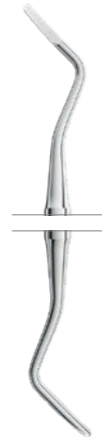

3 Goldman-Fox
1809-3
Asa60
MV1809-3
Asa Light MV
ML1809-3
Leonardo ML



4 Goldman-Fox
1809-4
Asa60
MV1809-4
Asa Light MV
ML1809-4
Leonardo ML

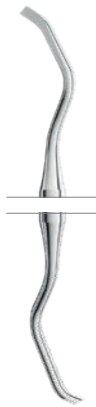

5 Goldman-Fox
1809-5
Asa60
MV1809-5
Asa Light MV
ML1809-5
Leonardo ML



6 Goldman-Fox
1809-6
Asa60
MV1809-6
Asa Light MV

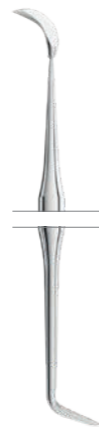

21 Goldman-Fox
1809-21
Asa60
MV1809-21
Asa Light MV
ML1809-21
Leonardo ML

CURETTES AND SCALERS



11/12 Mc Call
1825-12
Asa60
MV1825-12
Asa Light MV



11A/12A Mc Call
1825-12A
Asa60



13/14 Mc Call
1825-14
Asa60
MV1825-14
Asa Light MV
RC1825-14/
RC1825-14SF
● AsaWave RC



13S/14S Mc Call
1825-14S
Asa60
MV1825-14S
Asa Light MV
ML1825-14S
Leonardo ML
RC1825-14S/
RC1825-14SSF
● AsaWave RC

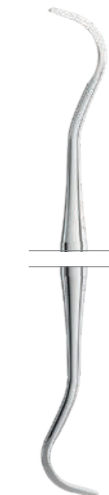

17S/18S Mc Call
1825-18S
Asa60
MV1825-18S
Asa Light MV



19/20 Mc Call
1825-20
Asa60
MV1825-20
Asa Light MV

CURETTES AND SCALERS



6S Mini Crane-Kaplan
RC1829-CK6SSF
 ● AsaWave RC
1829-CK6S
 Asa60
ML1829-CK6S
 Leonardo ML
RC1829-CK6S
 ● AsaWave RC

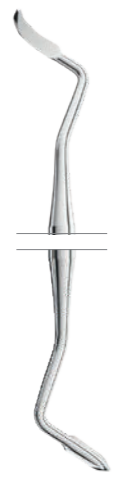

204
1827-204
 Asa60

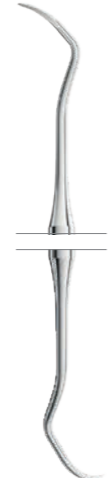

204S
1827-204S
 Asa60
MV1827-204S
 Asa Light MV
ML1827-204S
 Leonardo ML
LV1827-204S
 Leonardo Light LV
RC1827-204S/
RC1827-204SSF
 ● AsaWave RC

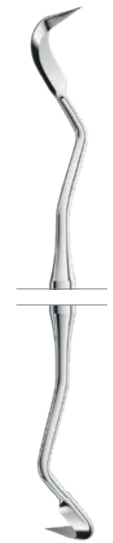

6 Crane-Kaplan
1829-CK6
 Asa60
MV1829-CK6
 Asa Light MV
ML1829-CK6
 Leonardo ML
LV1829-CK6
 Leonardo Light LV
RC1829-CK6/
RC1829-CK6SF
 ● AsaWave RC



2/3 Taylor
1826-T03
 Asa60
MV1826-T03
 Asa Light MV
ML1826-T03
 Leonardo ML
LV1826-T03
 Leonardo Light LV



7/8 Younger-Good
1830-YG08
 Asa60
MV1830-YG08
 Asa Light MV
ML1830-YG08
 Leonardo ML

CURETTES AND SCALERS



31/32 Jacquette
1831-32
 Asa60
MV1831-32
 Asa Light MV

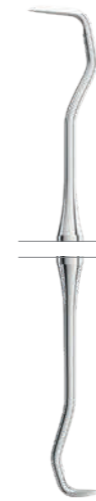

30/33 Jacquette
1831-33
 Asa60
MV1831-33
 Asa Light MV

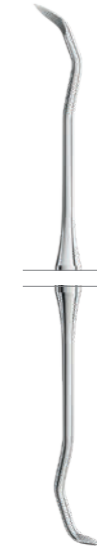

34/35 Jacquette
1831-35
 Asa60
MV1831-35
 Asa Light MV

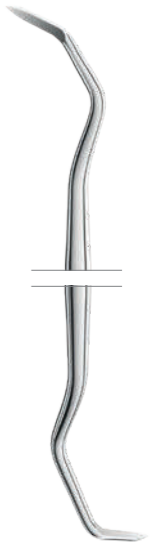

37/38 Jacquette
1831-38
 Asa60
MV1831-38
 Asa Light MV

1831-32



GRACEY USE CHART

- Anterior sextants of teeth
 - GRA 1/2 Incisors and Canines
 - GRA 3/4 Incisors and Canines
 - GRA 5/6 Anteriors and Premolars
- Buccal and lingual surfaces of posterior teeth
 - GRA 7/8 Premolars and Molars
 - GRA 9/10 Premolars and Molars
- Mesial surfaces of posterior teeth
 - GRA 11/12 Premolars and Molars
 - GRA 15/16 Premolars and Molars
- Distal surfaces of posterior teeth
 - GRA 13/14 Molars
 - GRA 17/18 Molars

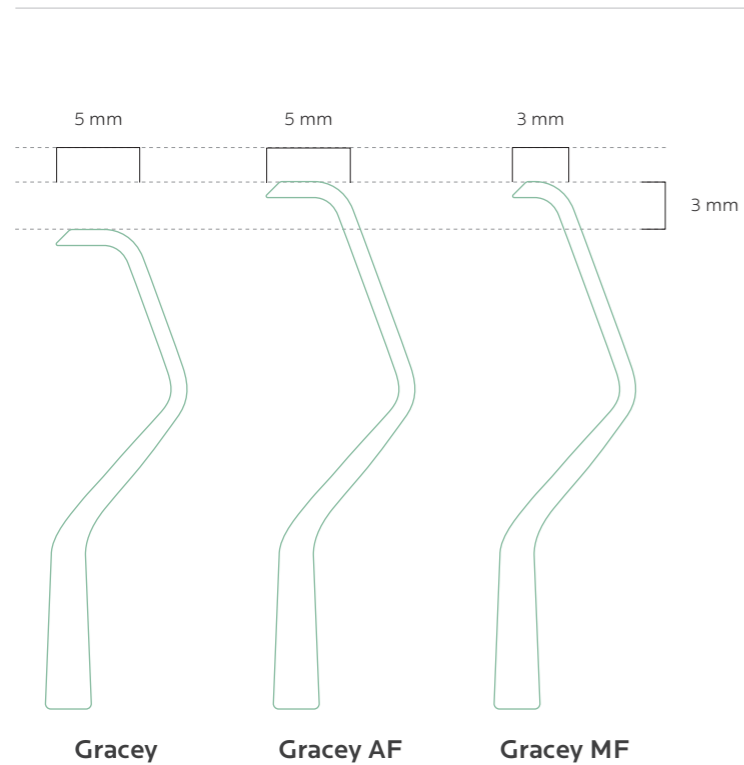
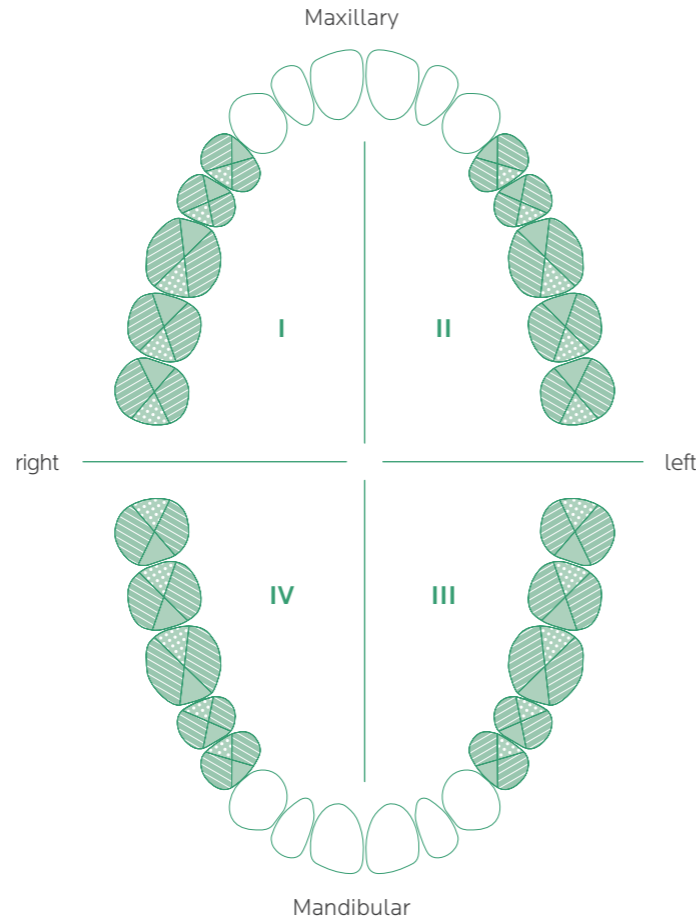

AsaWave Handles

- GRA 1/2
- GRA 3/4
- GRA 5/6
- GRA 7/8
- GRA 9/10
- GRA 11/12
- GRA 13/14
- GRA 15/16
- GRA 17/18

GRACEY CURETTES

3/4 Gracey 1807-04 Asa60 MV1807-04 Asa Light MV ML1807-04 Leonardo ML LV1807-04/ LV1807-04SF Leonardo Light LV RC1807-04/ RC1807-04SF ● AsaWave RC	5/6 Gracey 1807-06 Asa60 MV1807-06 Asa Light MV ML1807-06 Leonardo ML LV1807-06/ LV1807-06SF Leonardo Light LV RC1807-06/ RC1807-06SF ● AsaWave RCSF	7/8 Gracey 1807-08 Asa60 MV1807-08 Asa Light MV ML1807-08 Leonardo ML LV1807-08/ LV1807-08SF Leonardo Light LV RC1807-08/ RC1807-08SF ● AsaWave RC	9/10 Gracey 1807-10 Asa60 MV1807-10 Asa Light MV ML1807-10 Leonardo ML LV1807-10/ LV1807-10SF Leonardo Light LV RC1807-10/ RC1807-10SF ● AsaWave RC	11/12 Gracey 1807-12 Asa60 MV1807-12 Asa Light MV ML1807-12 Leonardo ML LV1807-12/ LV1807-12SF Leonardo Light LV RC1807-12/ RC1807-12SF ● AsaWave RC	
1/2 Gracey LV1807-02SF Leonardo Light LV 1807-02 Asa60 MV1807-02 Asa Light MV ML1807-02 Leonardo ML LV1807-02 Leonardo Light LV RC1807-02/ RC1807-02SF ● AsaWave RC	13/14 Gracey 1807-14 Asa60 MV1807-14 Asa Light MV ML1807-14 Leonardo ML LV1807-14/ LV1807-14SF Leonardo Light LV RC1807-14/ RC1807-14SF ● AsaWave RC	15/16 Gracey 1807-16 Asa60 ML1807-16 Leonardo ML LV1807-16/ LV1807-16SF Leonardo Light LV RC1807-16/ RC1807-16SF ● AsaWave RC	17/18 Gracey 1807-18 Asa60 ML1807-18 Leonardo ML LV1807-18/ LV1807-18SF Leonardo Light LV RC1807-18/ RC1807-18SF ● AsaWave RC	11/14 Gracey Mesial-Distal 1807-11MD Asa60 MV1807-11MD Asa Light MV ML1807-11MD Leonardo ML LV1807-11MD Leonardo Light LV	12/13 Gracey Mesial-Distal 1807-13MD Asa60 MV1807-13MD Asa Light MV ML1807-13MD Leonardo ML LV1807-13MD Leonardo Light LV

GRACEY CURETTES - AF

GRACEY CURETTES - MF



1/2 Gracey
LV1807-02AF
 Leonardo Light LV
1807-02AF
 Asa60
ML1807-02AF
 Leonardo ML

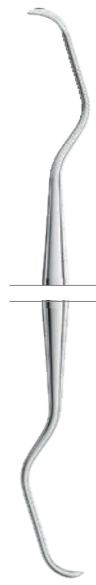

3/4 Gracey
1807-04AF
 Asa60
ML1807-04AF
 Leonardo ML
LV1807-04AF
 Leonardo Light LV



5/6 Gracey
1807-06AF
 Asa60
ML1807-06AF
 Leonardo ML
LV1807-06AF
 Leonardo Light LV

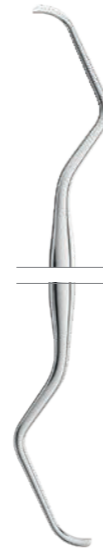

7/8 Gracey
1807-08AF
 Asa60
ML1807-08AF
 Leonardo ML
LV1807-08AF
 Leonardo Light LV



11/12 Gracey
1807-12AF
 Asa60
ML1807-12AF
 Leonardo ML
LV1807-12AF
 Leonardo Light LV

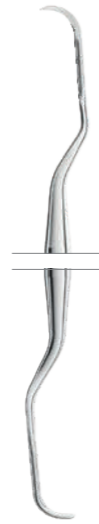

13/14 Gracey
1807-14AF
 Asa60
ML1807-14AF
 Leonardo ML
LV1807-14AF
 Leonardo Light LV

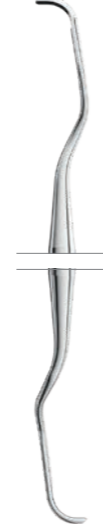

15/16 Gracey
1807-16AF
 Asa60
ML1807-16AF
 Leonardo ML
LV1807-16AF
 Leonardo Light LV



1/2 Gracey
LV1807-02MF
 Leonardo Light LV
1807-02MF
 Asa60
ML1807-02MF
 Leonardo ML



3/4 Gracey
1807-04MF
 Asa60
ML1807-04MF
 Leonardo ML
LV1807-04MF
 Leonardo Light LV

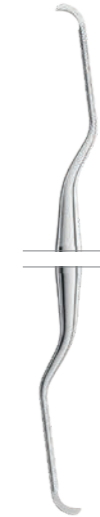

5/6 Gracey
1807-06MF
 Asa60
ML1807-06MF
 Leonardo ML
LV1807-06MF
 Leonardo Light LV

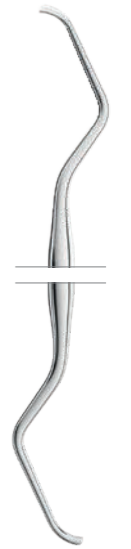

7/8 Gracey
1807-08MF
 Asa60
ML1807-08MF
 Leonardo ML
LV1807-08MF
 Leonardo Light LV

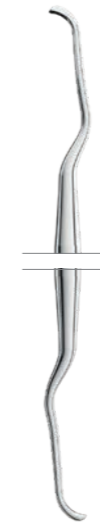

11/12 Gracey
1807-12MF
 Asa60
ML1807-12MF
 Leonardo ML
LV1807-12MF
 Leonardo Light LV

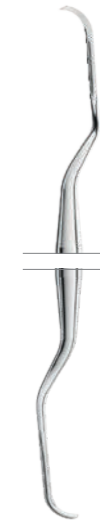

13/14 Gracey
1807-14MF
 Asa60
ML1807-14MF
 Leonardo ML
LV1807-14MF
 Leonardo Light LV

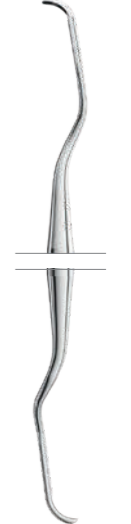

15/16 Gracey
1807-16MF
 Asa60
ML1807-16MF
 Leonardo ML
LV1807-16MF
 Leonardo Light LV

SCALERS



U15 Towner
ML1903
Leonardo ML
1903
Asa60

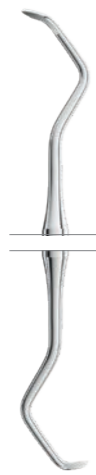

M23
Universal Scaler
1900-M23
Asa60
ML1900-M23
Leonardo ML
RC1900-M23/
RC1900-M23SF
● AsaWave RC

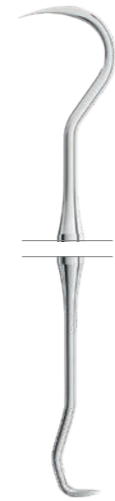

U15/33
Towner Jacquette
1902-1
Asa60
MV1902-1
Asa Light MV
ML1902-1
Leonardo ML
RC1902-1/
RC1902-1SF
● AsaWave RC

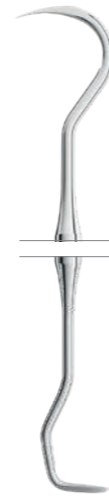

U15/30
Towner Jacquette
1902-2
Asa60
MV1902-2
Asa Light MV
RC1902-2/
RC1902-2SF
● AsaWave RC

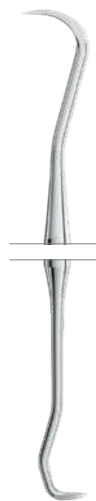

H5/33
1904-H5
Asa60
MV1904-H5
Asa Light MV
RC1904-H5/
RC1904-H5SF
● AsaWave RC

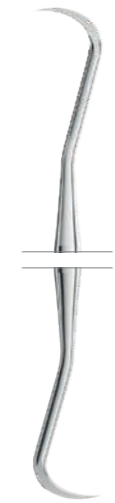

H6/H7
1904-H6
Asa60
MV1904-H6
Asa Light MV
RC1904-H6/
RC1904-H6SF
● AsaWave RC

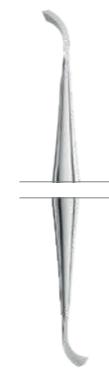

1/2
1905-02
Asa60
MV1905-02
Asa Light MV

SCALERS



1
1901-1
Asa60



1L
left
1900-1L
Asa60



1R
right
1900-1R
Asa60



2L
left
1900-2L
Asa60



2R
right
1900-2R
Asa60



H5 Hygienist
1909-H5
Asa60



H6 Hygienist
1909-H6
Asa60



H7 Hygienist
1909-H7
Asa60



33
1906-33
Asa60



1 Jacquette
ML1906-1
Leonardo ML



2 Jacquette
ML1906-2
Leonardo ML



3 Jacquette
ML1906-3
Leonardo ML

PERIOSTEALS AND ELEVATORS

3 mm
LANCE TIP



3 mm
ROUNDED TIP
Buser
PR1850-M
Perfection

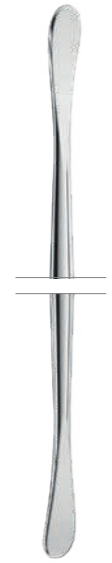

GF Goldman-Fox
MV1850-GF
Asa Light MV



M7 Molt
MV1850-M7
Asa Light MV

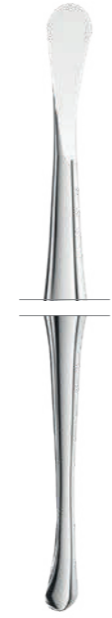

M8 Molt
MV1850-M8
Asa Light MV

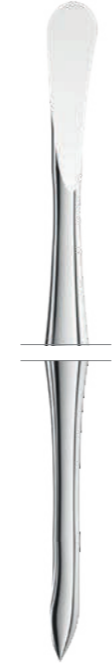

M9 Molt
MV1850-M9
Asa Light MV

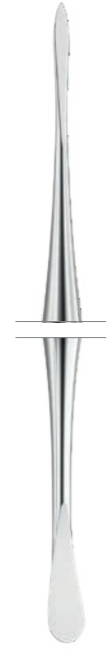

Beale
5114-1
Octagonal



9A Allen
MV1850-9A
Asa Light MV



2 Hourigan
MV1851-2
Asa Light MV



PR3 Prichard
MV1851-PR3
Asa Light MV

PERIOSTEALS AND ELEVATORS



1 Hopkins
MV1852-1
Asa Light MV



2 Hopkins
MV1852-2
Asa Light MV



Partsch
14.5 cm
1849-1
Asa60



3 Mead
MV1854-3
Asa Light MV



15 Freer
MV1853-15
Asa Light MV



16 Freer
MV1853-16
Asa Light MV

PERIOSTEALS AND ELEVATORS

PERIOSTEALS AND ELEVATORS

2 mm



2.5 mm
17 cm
PR1850-1
 Perfection



22 Seldin
 retractor
1855-22



23 Seldin
 retractor
1855-23



König
 15.5 cm
1858-1



Williger
 17 cm
1856-1



Williger
 16 cm
1856-2



Williger
 16 cm
1857-1



Williger
 13 cm
1857-2

BONE CURETTES

1 Hemingway 2000-1
Asa60
MV2000-1
Asa Light MV
ML2000-1
Leonardo ML

2 Hemingway 2000-2
Asa60
MV2000-2
Asa Light MV
ML2000-2
Leonardo ML

3 Hemingway 2000-3
Asa60
MV2000-3
Asa Light MV
ML2000-3
Leonardo ML

4 Hemingway 2000-4
Asa60
MV2000-4
Asa Light MV
ML2000-4
Leonardo ML

85 Lucas 2001-85
Asa60
MV2001-85
Asa Light MV
ML2001-85
Leonardo ML
RC2001-85
● AsaWave RC

86 Lucas 2001-86
Asa60
MV2001-86
Asa Light MV
ML2001-86
Leonardo ML
RC2001-86
● AsaWave RC

87 Lucas 2001-87
Asa60
MV2001-87
Asa Light MV
ML2001-87
Leonardo ML
RC2001-87
● AsaWave RC

88 Lucas 2001-88
Asa60
MV2001-88
Asa Light MV
ML2001-88
Leonardo ML
RC2001-88
● AsaWave RC

BONE CURETTES

00/0 Williger 14 cm
2015-00

1/2 Williger 14 cm
2015-1

00/0 Williger 14 cm
2016-00

1/2 Williger 14 cm
2016-1

2 U.S.A. pattern 16 cm
2013-2

2R U.S.A. pattern 16 cm
2013-2R

2L U.S.A. pattern 16 cm
2013-2L

FILES



3/7 Hirschfeld
1810-07
Asa60
MV1810-07
Asa Light MV

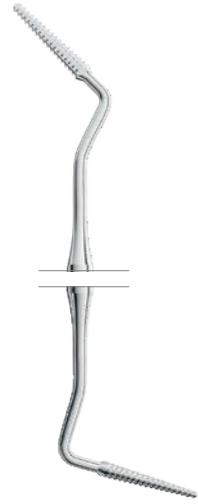

1S/2S Sugarman
1812-02S
Asa60
MV1812-02S
Asa Light MV

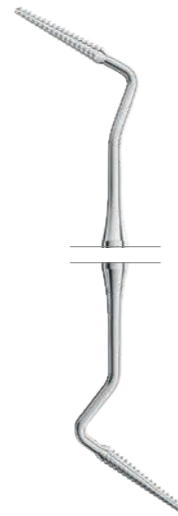

3S/4S Sugarman
1812-04S
Asa60
MV1812-04S
Asa Light MV

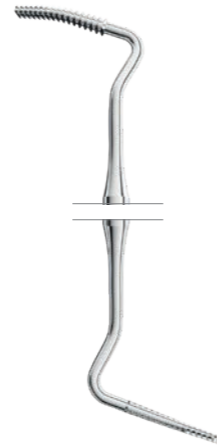

9/10 Schluger
1813-10
Asa60
MV1813-10
Asa Light MV

1812-04S

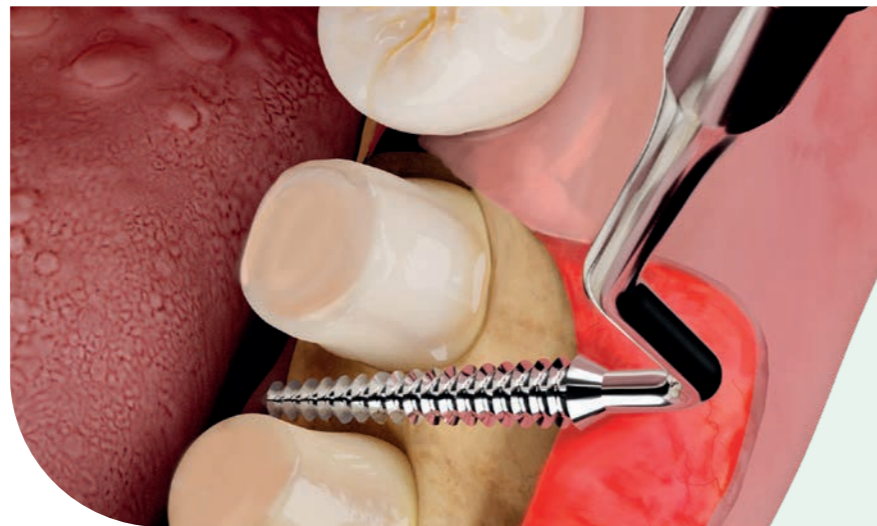

BONE FILES



1 Polokoff
2003-1



33
2004-33



12 Howard
2008-12



45 Miller
2005-45



12A
2007-12A



64 Miller
2005-64



12CA
2007-12CA



10
2006-10



1 Wahl
MV2002-1
Asa Light MV



2 Wahl
MV2002-2
Asa Light MV

GINGIVECTOMY KNIVES

GINGIVECTOMY KNIVES



1 (15K) Kirkland
1803-1
Asa60



2 (16K) Kirkland
1803-2
Asa60



1 Orban
1804-1
Asa60



2 Orban
1804-2
Asa60



1/2 (15K/16K) Kirkland
1803-D
Asa60
MV1803-D
Asa Light MV
ML1803-D
Leonardo ML



5/6 Buck
1816-06
Asa60
ML1816-06
Leonardo ML

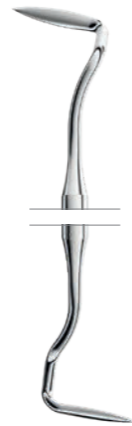

1/2 Orban
1804-D
Asa60
MV1804-D
Asa Light MV
ML1804-D
Leonardo ML



7 Goldman-Fox
1815-7
Asa60



8 Goldman-Fox
1815-8
Asa60



9 Goldman-Fox
1815-9
Asa60



11 Goldman-Fox
1815-11
Asa60

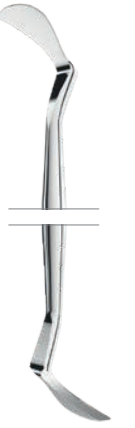

3/4 Buck
1816-04
Asa60



1/2 Sanders
1817-02
Asa60



4/5 Sanders
1817-05
Asa60

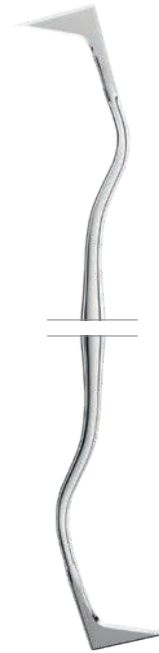

19/20
(University of South California)
USC Towner
1818-20
Asa60

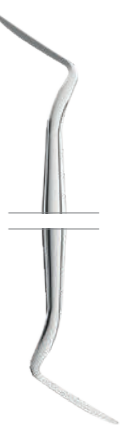

CK3 Crane-Kaplan
1819-CK3
Asa60

CHISELS

BONE CHISELS AND GOUGES



3 Ochsenbein
1802-3
Asa60
MV1802-3
Asa Light MV

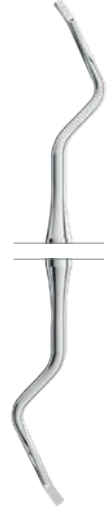

4 Ochsenbein
1802-4
Asa60
MV1802-4
Asa Light MV



36/37 Rhodes back-action
1811-37
Asa60
MV1811-37
Asa Light MV



1 TG Chisel
1801-1
Asa60



2 TG Chisel
1801-2
Asa60



1/2 TG Chisel
1801-D
Asa60
MV1801-D
Asa Light MV



1 Ochsenbein
1800-1



2 Ochsenbein
1800-2



6 Gardner
1832-6



1 Gardner
1832-1



1W Wakefield
1833-1W



2 Gardner
1832-2



2W Wakefield
1833-2W



5 Gardner
1832-5



3 Buckley
1834-3



5R Gardner
1832-5R

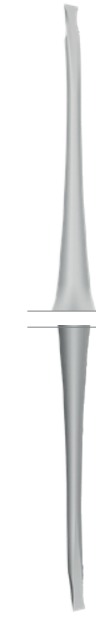

17 cm PR1801-1
Perfection

BONE CHISELS AND GOUGES

3 mm



Partsch
13.5 cm
1835-3

4 mm



Partsch
13.5 cm
1835-4

5 mm



Partsch
13.5 cm
1835-5

6 mm



Partsch
13.5 cm
1835-6

3 mm



Partsch
17 cm
1836-3

4 mm



Partsch
17 cm
1836-4

5 mm



Partsch
17 cm
1836-5

6 mm



Partsch
17 cm
1836-6

3 mm



Partsch
13.5 cm
1837-3

4 mm



Partsch
13.5 cm
1837-4

5 mm



Partsch
13.5 cm
1837-5

6 mm



Partsch
13.5 cm
1837-6

3 mm



Partsch
17 cm
1838-3

4 mm



Partsch
17 cm
1838-4

5 mm



Partsch
17 cm
1838-5

6 mm



Partsch
17 cm
1838-6

SURGICAL MALLET

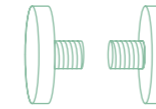

1881-R
#2 Teflon inserts
autoclavable
max 120°

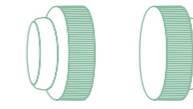

interchangeable
Ferozell
inserts



Partsch
19 cm
1880
lead filled



Mead
19.5 cm
1881



Mead
17 cm
1882



Vickers
19 cm
1884



Herbert
19 cm
1885

PERIODONTAL INSTRUMENTS



Tomati
19 cm
0103-78
gum guillotine
forceps

Goldman-Fox
10 cm
0103-60
bone/soft tissue nipper with
small beaks for use in limited
access areas

Mini Friedman
12 cm
0103-25
bone rongeur

PERIODONTAL POCKET MARKERS



0650-2

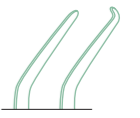
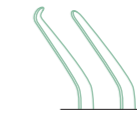

1 (Crane-Kaplan)
Goldman-Fox
15 cm
0650-1



2 (Crane-Kaplan)
Goldman-Fox
15 cm
0650-2

GRINDING STONES

Corundum grinding stone

India, beige, for sharpening very blunt instruments

75 x 45 x 2-7 mm

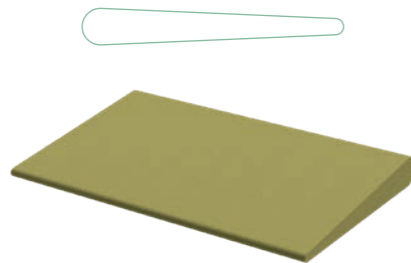

fine grain
1890-1F

75 x 45 x 2-7 mm

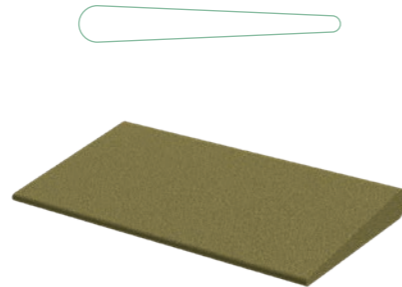

medium grain
1890-1M

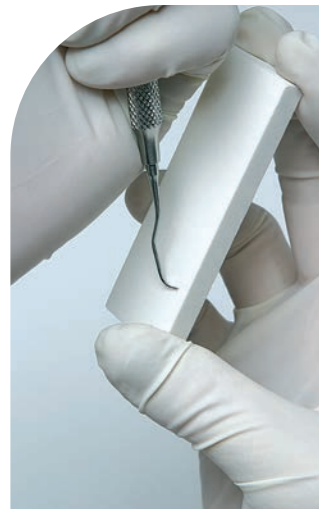

75 x 25 x 7 mm



1890-2

grayish-white "Arkansas" grinding stone, for repeated sharpening of scalers and curettes as well as for finishing.

100 x 25 x 10 mm



1890-3

white Super "Arkansas" grinding stone, for repeated sharpening of scalers and curettes as well as for finishing.



102 x 26 x 5-10 mm

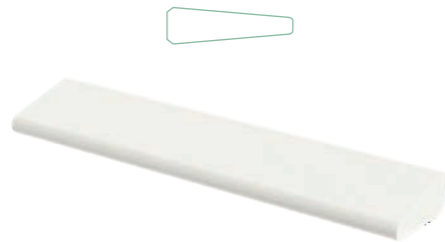

1890-4

Arkansas grinding stone, convex file, for finishing.

100 mm x Ø 6 mm

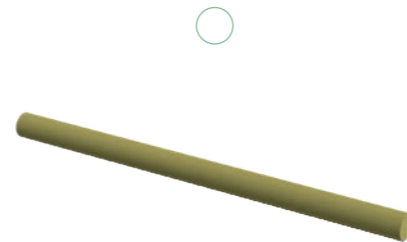

1890-5

dark beige India Corundum grinding stone, round file, for deburring working ends.

GRINDING STONES



100 mm x max Ø 10 mm

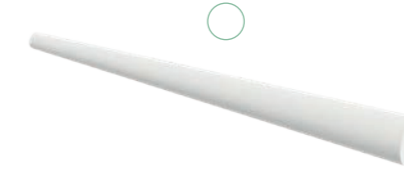

1890-6

greyish-white "Arkansas" grinding stone, round file, for deburring working ends.

102 x 8 mm - 15 x 2 - 6 mm



1890-7

green silicon carbide grinding stone, tapered, for deburring working ends.



100 mm x max Ø 10 mm



1891-1

plexiglass test rod for checking sharpness of scalers and curettes
6 pcs / bag.

155 x 80 x 120 mm



S1890

case with grinding stones and oil.



Asa Oil
40 ml
8001

oil for grinding stones, physiologically safe.

KIT OF GRACEY CURETTES

Set of 3



Model	Set Code	Handle
08 · 12 · 14	S1807-3	Asa60

Set of 3



Model	Set Code	Handle
08AF · 12AF · 14AF	S1807AF-3	Asa60

Set of 3



Model	Set Code	Handle
08MF · 12MF · 14MF	S1807MF-3	Asa60

Set of 7



Model	Set Code	Handle
02 · 04 · 06 · 08 · 10 · 12 · 14	S1807	Asa60
02 · 04 · 06 · 08 · 10 · 12 · 14	SMV1807	Asa Light MV
02 · 04 · 06 · 08 · 10 · 12 · 14	SML1807	Leonardo ML
02 · 04 · 06 · 08 · 10 · 12 · 14	SLV1807	Leonardo Light LV
02 · 04 · 06 · 08 · 10 · 12 · 14	SRC1807	AsaWave RC

Set of 7



Model	Set Code	Handle
02AF · 04AF · 06AF · 08AF · 12AF · 14AF · 16AF	S1807AF	Asa60
02AF · 04AF · 06AF · 08AF · 12AF · 14AF · 16AF	SML1807AF	Leonardo ML
02AF · 04AF · 06AF · 08AF · 12AF · 14AF · 16AF	SLV1807AF	Leonardo Light LV

Set of 7



Model	Set Code	Handle
02MF · 04MF · 06MF · 08MF · 12MF · 14MF · 16MF	S1807MF	Asa60
02MF · 04MF · 06MF · 08MF · 12MF · 14MF · 16MF	SML1807MF	Leonardo ML
02MF · 04MF · 06MF · 08MF · 12MF · 14MF · 16MF	SLV1807MF	Leonardo Light LV

INSTRUMENT KIT FOR PERIODONTOLOGY



S1899

0304-2	Goldman-Fox gum scissors curved, sawed edge	2
0650-1	Goldman-Fox periodontal pocket marker, right side	1
0650-2	Goldman-Fox periodontal pocket marker, left side	2
0703L-1	Williams periodontal pocket probe	
1803-D	Kirkland gingivectomy knife	15K/16K
1804-D	Orban gingivectomy knife	1/2
1807-06	Gracey curette	5/6
1807-12	Gracey curette	11/12
1807-14	Gracey curette	13/14
1809-1	Goldman-Fox Universal scaler	1
1816-06	Buck gingivectomy knife	5/6
1825-14	Mc Call scaler	13/14
1829-CK6	Crane-Kaplan scaler	6
1903	Towner scaler	U15
MV1850-M9	Molt periosteal elevator	M9

PERIODONTAL INSTRUMENTS

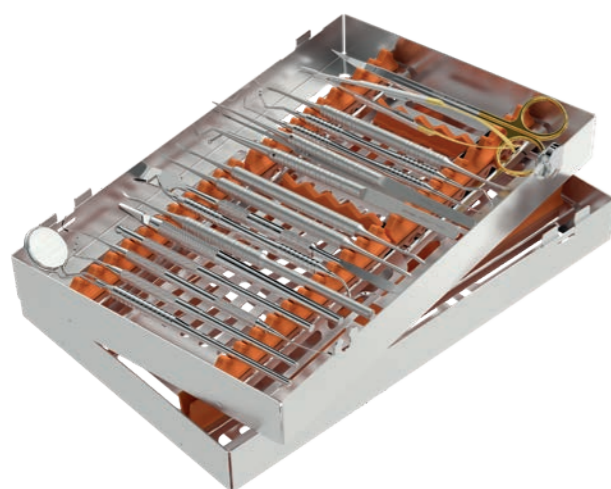

Periodontal surgery kit
SPR2781-P

ML2101	mouth mirror handle	
2230-5	double sided mouth mirrors	5
0702L-15	periodontal pocket probes	CP-15
0708L-2N	double-ended periodontal pocket probes	2N
0365-1	micro-blade holder	
0350-5	scalpel handle and blade	5
PR1857-1	exciser	
ML1804-D	Orban gingivectomy knife	1/2
MV1851-PR3	Prichard periosteal	PR3
PR1850-M	periosteal elevator	
PR1850-1	periosteal elevator	
PR0625-3	tissue pliers	
PR0632-1	atraumatic tissue pliers	
ML1806-2RL	periodontal instrument	2R/2L
ML1806-4RL	periodontal instrument	4R/4L
PR1801-1	small bone chisel	
PR0460-15TC	Castroviejo needle holder	
0309-2TC	gum scissors	2TC
2780-1A	instrument tray	



Periodontal first examination kit
S0600-1

2102-IN	mouth mirrors handle	
2200-4	plane mouth mirror	4
0704-23D1	double-ended explorer	23/17
0708-1N	periodontal pocket probe	1N
0702L-12	periodontal pocket probe	CP-12
0601-2	London-College cotton and dressing pliers	2
S2702	perforated instrument tray complete with insert frame	

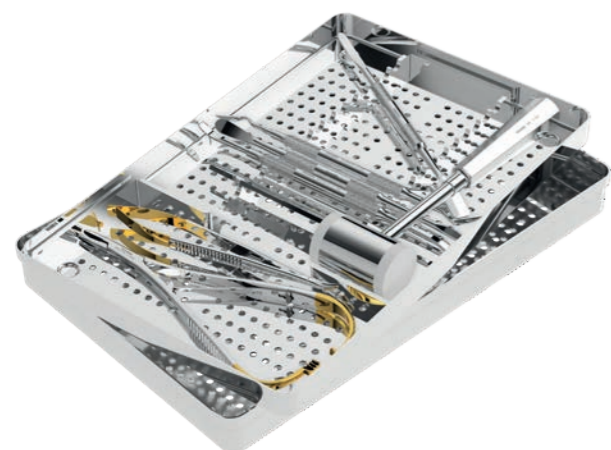

S3003-9

MV1850-M9	Molt periosteal	M9
MV1851-PR3	Prichard periosteal	PR3
MV1850-GF	Goldman-Fox periosteal	GF
MV1803-D	Kirkland knife	15K/16K
1881	Mead mallet	
0446TH-14TC	Castroviejo needle holder	
0435-17TC	Mathieu needle holder	
0350-3	scalpel handle	3
S2722-1	perforated instrument tray complete with insert frame	

PERIODONTAL INSTRUMENTS



S3003-11

0350-3	scalpel handle	3
2602-1	Sternberg retractor	
0304-2	Goldman-Fox scissor	2
MV1850-M9	Molt periosteal	M9
MV1851-PR3	Prichard periosteal	PR3
0415-15TC	Crile Wood needle holder	
0631-1	Semken Taylor tissue plier	1
0700-23	explorer with an anatomic handle	23
2102-IN	mouth mirror handle	
2200-5	mouth mirror	5
0351-11	scalpel blades (100 pcs)	11
S2722-1	perforated instrument tray complete with insert frame	

Instrument set manufactured according to the instructions of Prof. Guido Goracci, tenured Professor at the Department of Conservative Dentistry at La Sapienza University in Rome.



S1800-23

1811-37	Rhodes back-action file	36/37
1803-1	Kirkland knife	15K
1816-04	Buck knife	3/4
1815-7	Goldman-Fox knife	7
1817-02	Sanders knife	1/2
1805-02	Langer curette	HU 1/2
1821-06	Bernhart scaler	5/6
1823-R04	Rule scaler	3/4
1808-1	De Marco scaler	1
1809-5	Goldman-Fox scaler	5
1809-6	Goldman-Fox scaler	6
1825-12	McCall curette	11/12
1825-12A	McCall curette	11A/12A
1827-204	curette	204
1831-32	Jacquette curette	31/32
1904-H5	curette	H5/33
1810-07	Hirschfeld file	3/7
1812-02S	Sugarman file	1S/2S
1812-04S	Sugarman file	3S/4S
1801-D	chisel	1/2
1808-2	De Marco scaler	2
1803-2	Kirkland knife	2
1802-4	Ochsenbein bone chisel	4
S2720-2	instrument tray	

ORTHODONTICS

MADE IN ITALY



I4	Cutters
I10	Wire forming pliers
I29	Utility pliers
I34	Orthodontic instruments
I37	Prosthesis boxes

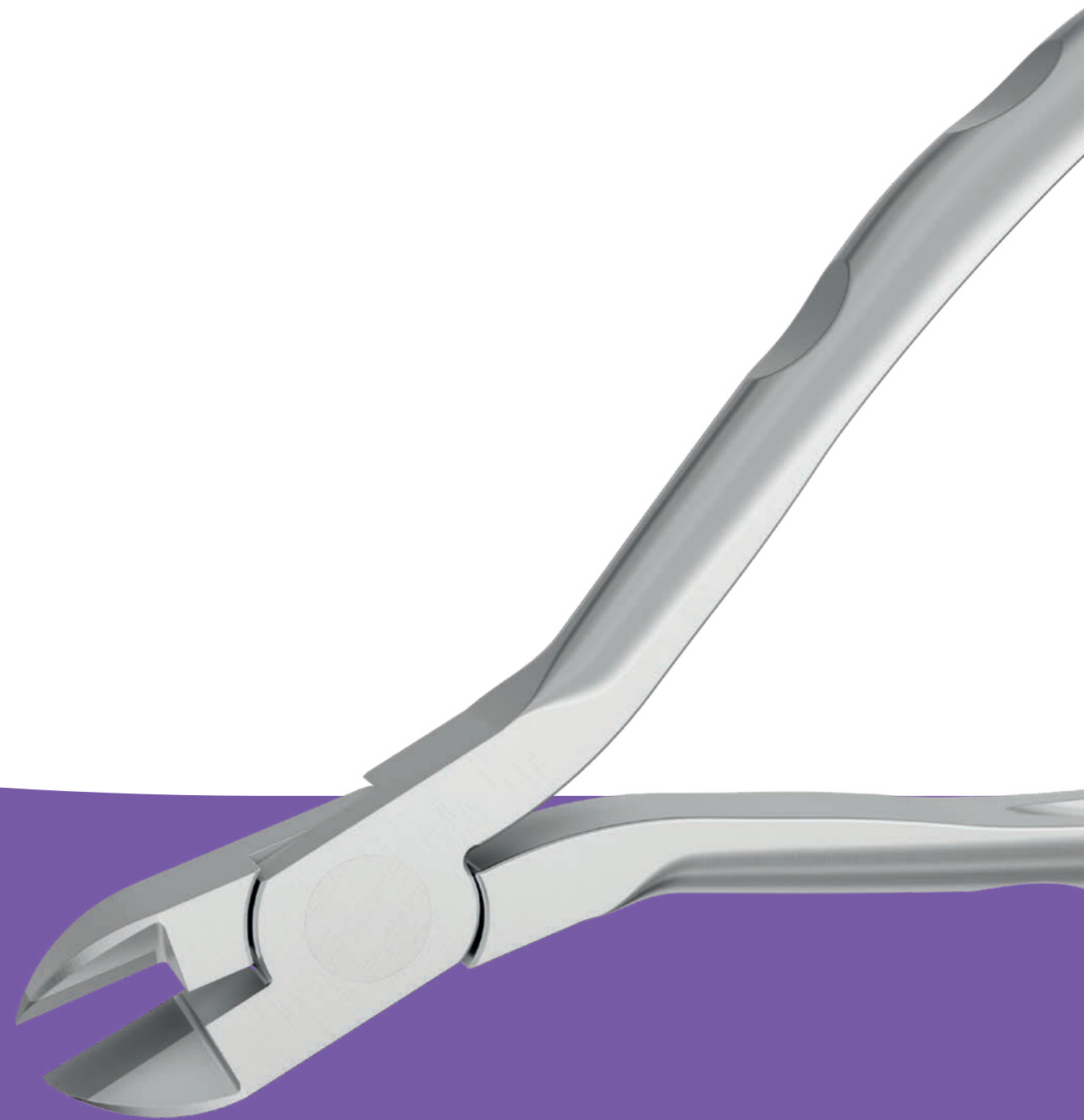

QUALITY AT THE RIGHT PRICE

Every specialist, independently of the work to be done, needs reliable instruments that can help them perform confidently and effectively. For this reason, Asa Dental offers two different lines of products. The first, our standard line, is comprised of instruments that provide the ideal trade-off between price and performance, designed to be within reach of just about everyone. The second, our Premium line, consists of a variety of instruments dedicated to professionals demanding unrivalled quality and ergonomics at all times. Because we believe in excellence and aim for perfection, but we also believe that dental care should be accessible to everyone.

HOW TO READ THIS CHAPTER



Premium orthodontic instrument



Premium orthodontic instrument with tungsten carbide (TC) inserts



Standard instrument



standard instrument with tungsten carbide (TC) inserts

HOW TO USE

when the full and partial view appear on the same page, the instrument is available in both premium and standard versions.

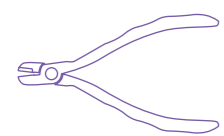

Full view
Premium orthodontic instrument
code starts with 88

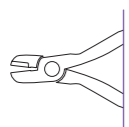

Partial view
standard instrument code
starts with 58

TECHNICAL DRAWING



drawings provide additional information about shape

CUTTERS



**hard wire cutter 15°
8812-2TC**

15° angle for hard-to-reach areas.

Wire size:
max. 0.56 mm x 0.70 mm (0.022" x 0.028")



**universal distal-end-cutter,
no hold
8813-1TC**

Mini universal distal end cutter, without safety hold.
Cuts flush to the bracket or buccal tube.

Wire size:
max. 0.56 mm x 0.70 mm (0.022" x 0.028")

CUTTERS

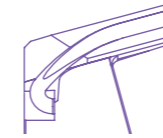

**distal end flush cutter
8826-1TC**

Distal end flush cutter with hard metal inserts.

Wire size:
max. 0.56 mm x 0.70 mm (0.022" x 0.028")



**universal distal-end cutter
8814-1TC**

Mini universal distal-end cutter, with safety hold to ensure patient safety and comfort during use.

Wire size:
max. 0.56 mm x 0.70 mm (0.022" x 0.028")

CUTTERS



mini ligature cutter
8824-1TC

Ligature cutter for hard wires, straight.
Slim profile for hard-to-reach areas.

Wire size:
max. 0.40 mm (0.015")



micro ligature cutter 15°
8827-1TC

Ligature cutter for hard wires, 15° angle.
Ultra slim profile for hard-to-reach areas.

Wire size:
max. 0.40 mm (0.015")

CUTTERS



multi-use wire cutter
8812-1TC

Versatile hard wire cutter.

Wire size:
max. 0.56 mm x 0.70 mm
(0.022" x 0.028")



multi-use wire cutter
5832



multi-use wire cutter
5832-1TC

Same as 5832, plus tungsten carbide inserts

CUTTERS



micro-miniature wire cutter
5833
 Ultra-slim soft wire cutter for ligature wires. Designed to fit in hard-to-reach areas.
Wire size:
 max. 0.30 mm (0.012")



micro-miniature wire cutter
5833-1TC
 Same as 5833 with tungsten carbide inserts

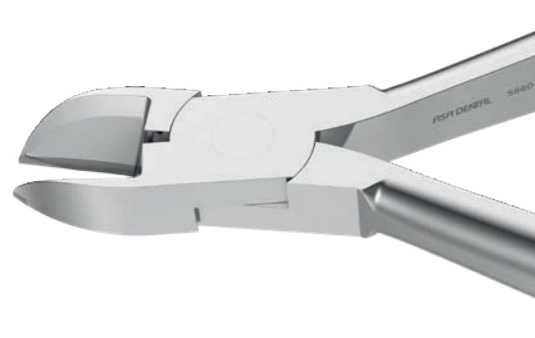

wire cutter <= 0.9 mm
5880-1
 Distal end cutter designed to cut wire pins and ligature wires, strong enough to bend wire ends after distal cutting.
Wire size:
 max. 0.9 mm (0.036")



wire cutter <= 1.5 mm
5880-2
 Distal end cutter designed to cut wire pins and ligature wires, strong enough to bend wire ends after distal cutting.
Wire size:
 max. 1.5 mm (0.044")

CUTTERS



wire cutter <= 1.2 mm
5880-3TC
 Distal end cutter designed to cut wire pins and ligature wires, strong enough to bend wire ends after distal cutting. With tungsten carbide inserts.
Wire size:
 max. 1.2 mm (0.044")



distal end cutter
5836
 Distal end cutter with safety hold designed to cut hard wires and hold the loose distal end, preventing damage to oral tissue.
Wire size:
 rectangular max. 0.56 mm x 0.7 mm (0.022" x 0.028")
 round max. 0.5 mm (0.020")



distal end cutter
5836-1TC
 Same as 5836 with tungsten carbide inserts



micro distal end cutter
5837
 Distal end cutter with safety hold designed to cut hard wires and hold the loose distal end, preventing damage to oral tissue.
Wire size:
 rectangular max. 0.56 mm x 0.7 mm (0.022" x 0.028")
 round max. 0.5 mm (0.020")

WIRE FORMING PLIERS



Delphin universal pliers
8801-1

Wire bending size:
max. 0.90 mm (0.035")
Wire cutting size:
max. 0.70 mm (0.028")



Delphin universal pliers
5801-1



universal pliers
5801-3



universal pliers
8801-2

Wire bending size:
max. 0.90 mm (0.035")
Wire cutting size:
max. 0.70 mm (0.028")

WIRE FORMING PLIERS

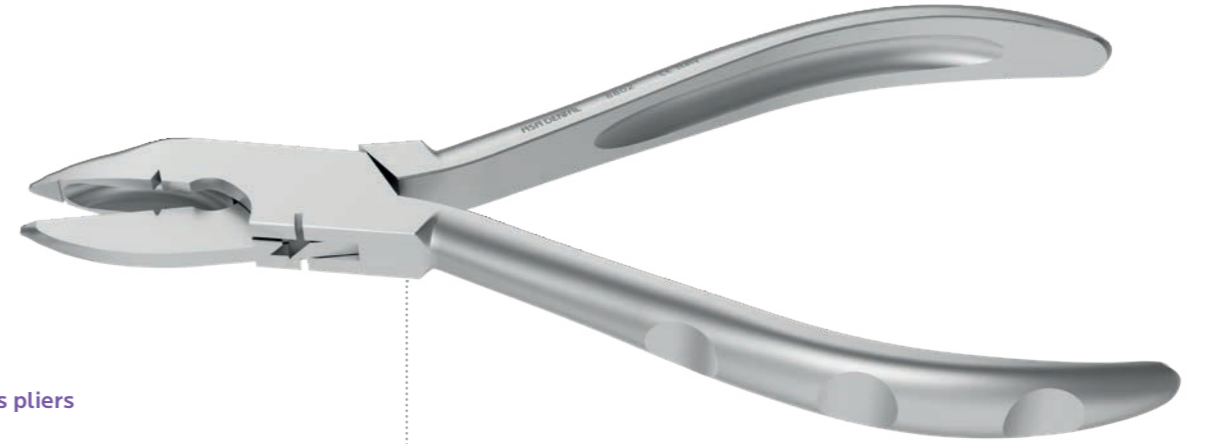

Waldsachs pliers
8802

Wire bending size:
max. 0.90 mm (0.035")
Wire cutting size:
max. 0.70 mm (0.028")



Waldsachs pliers
5802

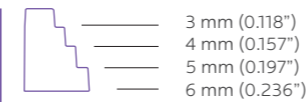

Nance precision pliers
8816

For precise forming of loops in 4 different lengths: 3, 4, 5 and 6 mm. A groove at the base aids in closing loops.

Wire size:
max. 0.70 mm (0.028")

WIRE FORMING PLIERS



**Nance pliers
5800**

Nance loop closing pliers, for bending of stoppers on arches and special pliers for Adams clasps.

Wire size:
max. 0.7 mm (0.028")



**round-concave pliers
5806**

Round-concave pliers for loop forming and bending of thin round or rectangular wire.

Wire size:
max. 0.5 mm (0.020")

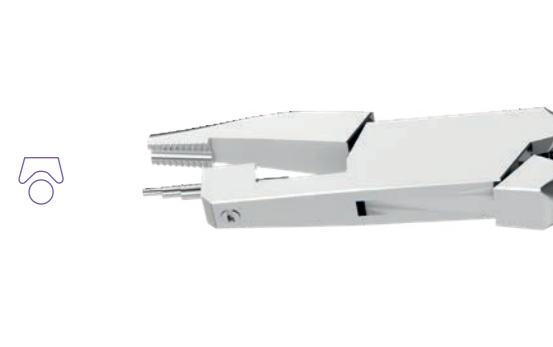

**Tweed loop pliers
5809-1**

Loop-forming pliers for round and rectangular wire, with a replaceable cylindrical beak. The concave beak with parallel serrations firmly holds the wire in position.

Wire size:
max. 0.56 x 0.7 mm (0.022"x 0.028")

Beak size:
1.15 mm (0.045"), 1.50 mm (0.059"), 1.90 mm (0.075")

WIRE FORMING PLIERS



1.20 mm (0.047")
1.60 mm (0.063")
2.00 mm (0.075")

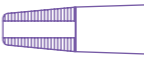

**Tweed Omega loop forming pliers
8804-2**

Loop-forming pliers for round and rectangular wires, with a replaceable cylindrical beak. The concave beak with parallel serrations firmly holds the wire in position.

Wire size:
max. 0.70 mm (0.028")



**Tweed Omega loop forming pliers
5809-2**



8804-2P
Replacement tip for pliers 8804-2



8804-3P
Replacement screw and L-key
for pliers 8804-2

WIRE FORMING PLIERS



- 1.60 mm (0.063")
- 2.20 mm (0.087")
- 2.80 mm (1.100")

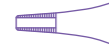

universal Tweed pliers
8804-1

Loop-forming pliers for creating bull and helical loops with different diameters.

Wire size:
max. 0.70 mm (0.028")

universal Tweed pliers
5870



Young pliers
5863



Young pliers
8817

Loop-forming pliers for loops of different lengths, ideal for labial arches.

Wire size:
max 0.70 mm (0.028")



WIRE FORMING PLIERS



Tweed loop pliers
5809-3

Single diameter loop-forming pliers with one cylindrical beak half and a concave serrated beak half.

Wire size:
max. 0.56 x 0.7 mm (0.022" x 0.28")

Beak size:
1.50 mm (0.059")



Tweed (Angle) pliers
5872-1

Pliers with short beaks (10 mm) designed for the forming of rectangular arches with square or rectangular wires. The blades are parallel when the pliers are 0.5 mm (0.020") open.



- 3 mm (0.118")
- 4 mm (0.157")
- 5 mm (0.197")
- 6 mm (0.236")

Nance loop pliers
5862

Designed for precise forming of loops in 4 different lengths, for round and rectangular wires.

Wire size:
max. 0.7 mm (0.028")

WIRE FORMING PLIERS



**Reynolds pliers
8805**
Contouring pliers



**Reynolds pliers
5812**

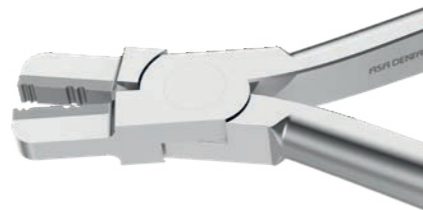

**lingual arch pliers
5818**



**lingual arch pliers
8807-3**
0.76 mm - 0.90 mm (0.030" - 0.036")
Wire size:
max. 0.90 mm (0.036")

WIRE FORMING PLIERS



**mini arch bending pliers
8807-1**
1.30 mm (0.050")
Wire size:
max. 0.56 mm x 0.64 mm (0.022" x 0.025")



**arch bending pliers
8807-2**
1.78 mm (0.067")
Wire size:
max. 0.56 mm x 0.64 mm (0.022" x 0.025")

WIRE FORMING PLIERS



De La Rosa grooved pliers
5821-1

Arch-forming pliers. Designed to form and contour arch wires on round or rectangular wire. The beak has grooves of 0.4 mm (0.016"), 0.46 mm (0.018") and 0.56 mm (0.022")

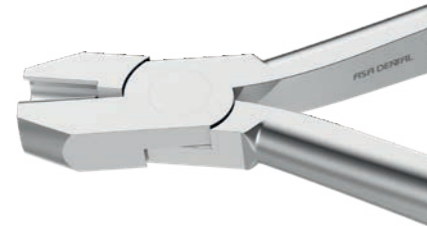

De La Rosa non-grooved pliers
5821-2

Arch-forming pliers with a non-grooved contouring surface for the forming of round or rectangular wire.



Mc Kellops pliers
5860-1

Round and concave heavy wire pliers. For forming loops in hard clasp wires or labial arch wires.

Wire size:
max. 0.8 mm (0.032")



flat wire bending pliers
5864

Wire bending pliers with flat tips.

Wire size:
max. 0.9 mm (0.036")

WIRE FORMING PLIERS



short round-jaw pliers
5865

Double rounded jaw wire and clasp bending pliers.

Wire size:
max. 0.7 mm (0.028")



long round-jaw pliers
5868

Double rounded jaw wire and clasp bending pliers.

Wire size:
max. 0.7 mm (0.028")



Angle pliers
5866

Bird beak angle pliers for bending round, square or rectangular wire.

Wire size:
max. 0.7 mm (0.028")



Angle pliers with a cutter
5838

Bird beak pliers for bending round, square or rectangular wire. With a cutter.

Wire size:
max. 0.7 mm (0.028")

WIRE FORMING PLIERS



**Adams pliers
8819**
Designed to create precise
90° bends



**Adams pliers
13 cm
5867-1**



**Adams pliers
14 cm
5867-2**



**Johnson pliers
5861**



**Johnson pliers
8815**
Crown & band contouring pliers

WIRE FORMING PLIERS



**Aderer mini pliers
8820-1**
Three-point wire bending
pliers.
Wire size:
max. 0.50 mm (0.020")

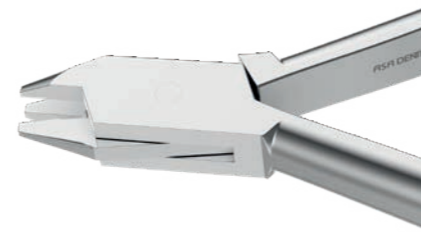

**Aderer mini pliers
5869-1**



**Aderer standard
pliers
5869-2**



**Aderer standard pliers
8820-2**
Three-point wire bending
pliers.
Wire size:
max. 0.70 mm (0.028")

WIRE FORMING PLIERS



universal bird beak pliers 8818

Versatile loop forming pliers for wires



bird beak pliers 8821

Light wire bird-beak pliers with a groove. The longer conical beak facilitates the creation of precise loops. The groove makes it easy to locate and duplicate loops.

Wire size:
max. 0.70 mm (0.028")



WIRE FORMING PLIERS



How universal pliers 8822-1

Straight. How utility pliers with cross-serrated tips. Perfect to position and remove orthodontic arches and pins

How universal pliers 5874-1



How curved pliers 5874-2



How curved pliers 8822-2

Curved. How utility pliers with cross-serrated tips angled at 40°, for hard-to-reach areas

WIRE FORMING PLIERS

10



lightweight bird beak pliers
5871
 Long-beak pliers designed for bending round, square or rectangular wire.
Wire size:
 max. 0.4 mm (0.016")

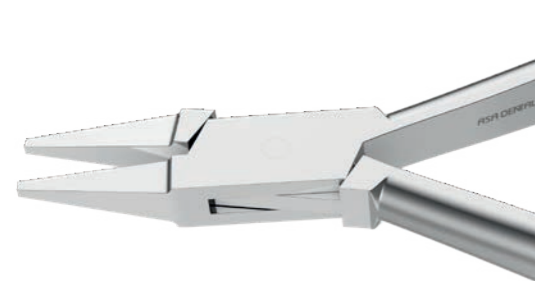

flat wire bending pliers
5875-1
 Flat nose pliers with fine, smooth beaks for bending wires.
Wire size:
 max. 0.7 mm (0.028")

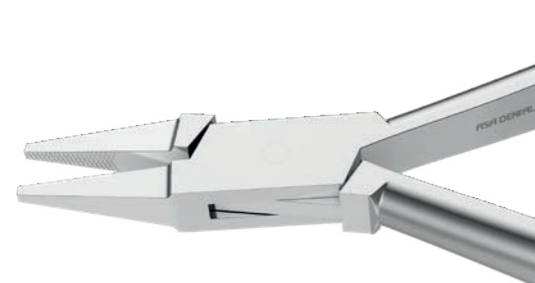

flat serrated wire-bending pliers
5875-2
 Fine, serrated flat-nose pliers for all wires.
Wire size:
 max. 0.7 mm (0.028")



serrated wire bending pliers
5876-1
Wire size:
 max. 0.7 mm (0.028")

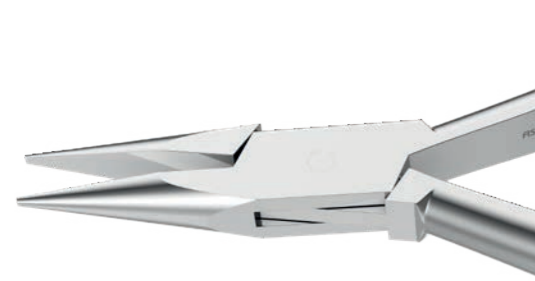

wire bending pliers
5876-2
Wire size:
 max. 0.7 mm (0.028")

WIRE FORMING PLIERS



Schwarz pliers
8823
 Schwarz arrow clasp forming pliers.
Wire size:
 max. 0.70 mm (0.028")

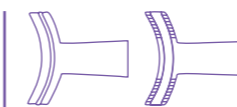

hammerhead NiTi pliers
8825
 Multi purpose pliers for easy NiTi wire bending and loop forming, without the use of heat

WIRE FORMING PLIERS



optical pliers
8803

Pliers with a groove, excellent for forming helical closing loops and wire bending of round and rectangular wire.

Wire size:
max. 0.70 mm (0.028")



Hollow Chop pliers
8806

Contouring pliers (De La Rosa). Ideal for arch contouring.

Wire size:
max. 0.70 mm (0.028")

WIRE FORMING PLIERS

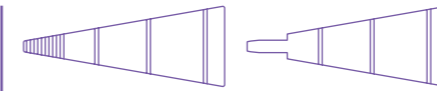

Jarabak pliers
8829

Multipurpose light wire bending pliers. Grooves allow precise bending and closing of loops.

Wire size:
max. 0.70 mm (0.028")



V-stop pliers
8830

Designed to create V-bends in archwires, including those in nickel titanium, and prevent archwire from travelling.

Wire size:
max. 0.70 mm (0.028")

WIRE FORMING PLIERS



universal Tweed pliers
8804-1



Adams pliers
8819

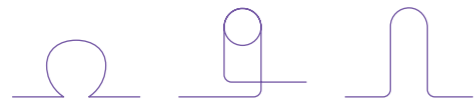

Tweed Omega loop forming pliers
8804-2

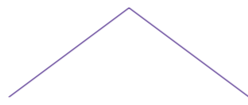

Aderer mini pliers
8820-1
Aderer standard pliers
8820-2



mini arch bending pliers
8807-1
arch bending pliers
8807-2

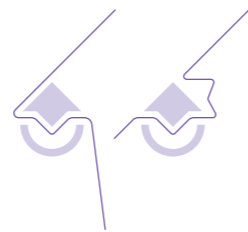

Schwarz pliers
8823



lingual arch pliers
8807-3



hammerhead NiTi pliers
8825



Nance precision pliers
8816



V-stop pliers
8830

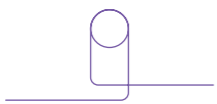

universal bird beak pliers
8818
bird beak pliers
8821

UTILITY PLIERS

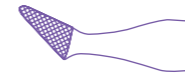

Weingart pliers
8808-1

Weingart utility pliers with cross-serrated tips, ideal for ligatures

Weingart pliers
5819

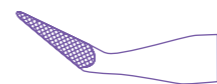

Weingart slim pliers
8808-2

Slim utility pliers with cross-serrated tips, ideal for ligatures

UTILITY PLIERS



**wide beak band removing pliers
5826-1**
Direct-bonded bracket remover with a wide beak pad. Designed for quick, easy and comfortable removal of direct-bonded brackets, slipping under the flange, and elimination of adhesive residues



**narrow beak band removing pliers
5826-2**
Direct-bonded bracket remover with a narrow beak. Similar in use to 5826-1

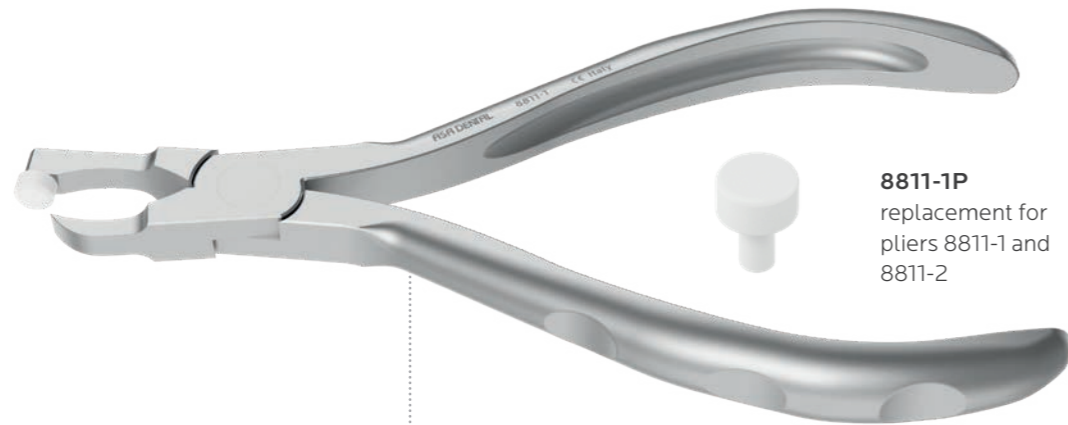

8811-1P
replacement for
pliers 8811-1 and
8811-2

**short posterior band remover
8811-1**
Posterior band and bracket removing pliers, short. The tip is aligned below the lower end of the occlusal pad



**short posterior band remover
5828-1**

UTILITY PLIERS

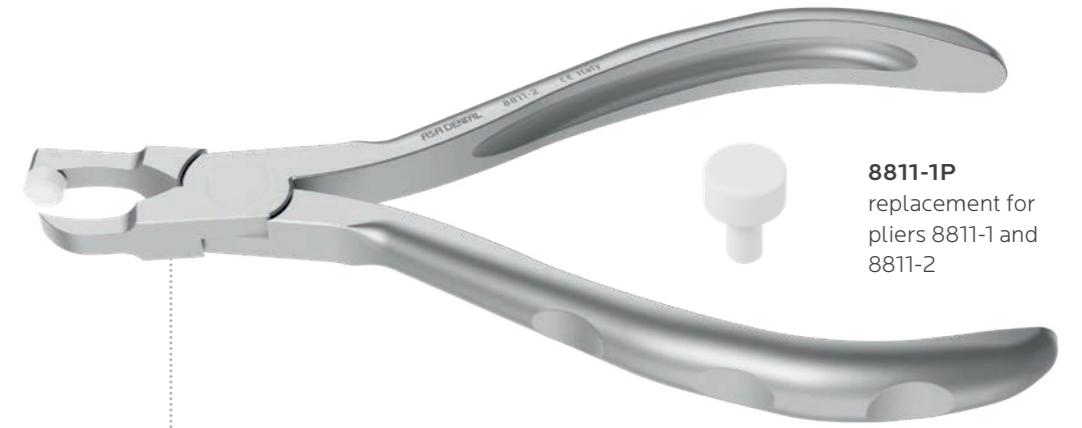

8811-1P
replacement for
pliers 8811-1 and
8811-2

**long posterior
band remover
8811-2**
Long posterior band and bracket removing pliers. The tip is centered below the lower edge of the occlusal pad.



**long posterior
band remover
5828-2**



**wide bracket
removing pliers
5824-1**



**wide bracket removing pliers
8809**
Bracket-removing pliers, straight. Ideal for all types of steel, plastic and ceramic brackets

UTILITY PLIERS



**angled bracket-removing pliers
8810**

Bracket-removing pliers, angled. Ideal for all types of steel, plastic and ceramic brackets



**angled bracket-removing pliers
5825**



8831-1P
replacement for
pliers 8831

**adhesive removing pliers
8831**

Adhesive-removing pliers with a reversible and replaceable blade

UTILITY PLIERS



**universal band slitter
8828-1TC**

Band slitter.

Wire size:
max. 0.40 mm (0.015")



8828-1TC

ORTHODONTIC INSTRUMENTS

Direct bond bracket holders

self-holding with reverse action will not release until pressed



13.5 cm
2400

13.5 cm
2402

13.5 cm
2401

Band pusher



Mershon
14 cm
2410

Band setter
with a tin insert



15 cm
2411

Band pusher
suitable for
saturated steam
sterilizers



13.5 cm
2412

ORTHODONTIC INSTRUMENTS

Ligature instruments

Band seating and
removing instruments



1350-1

1350-2

Elastic
instrument



1351-1

1352-1

separating forceps for
elastic chains and separators



15.5 cm
2450

ORTHODONTIC INSTRUMENTS

Bracket placement marker
available in 3.5 / 4.0 / 4.5 / 5.0 mm



8832

For elastic ligatures

2 mm

3 mm



Luniatschek
1355-1



Luniatschek
1355-2

Elastic forceps

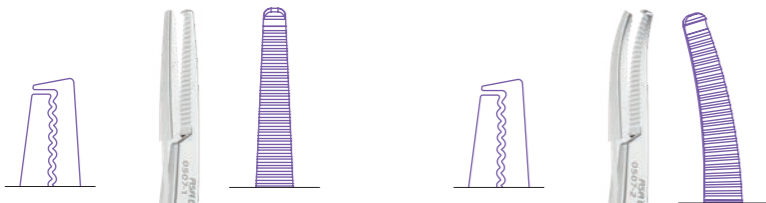

1 Halstead-Mosquito
straight
12 cm
0507-1



2 Halstead-Mosquito
curved
12 cm
0507-2

ORTHO/PROSTHESIS BOXES

Impact-resistant plastic box for removable retainers
10 pcs / pack



Blue
6900E-A



White
6900E-B



Light Blue
6900E-C



Yellow
6900E-G



Pink
6900E-R



Green
6900E-V

INSTRUMENT CASSETTES AND TRAYS

MADE IN ITALY

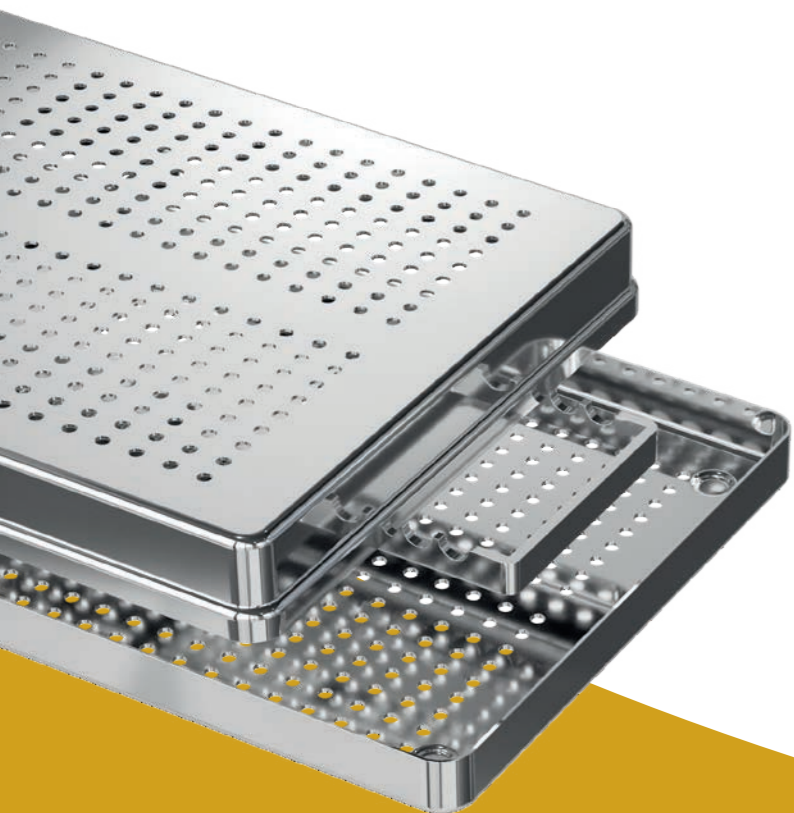

OPERATIONAL EFFICIENCY MADE EASY

The more your dental studio grows the more effective your procedures need to be. Efficiency becomes a direct consequence of an organized practice with proper instrument handling for greater efficiency and patient safety. Asa Dental manufactures trays, cassettes and boxes to conveniently transport, sterilize and store the instruments that make your daily practice crucial to improving the quality of life of your patients, whether they need to solve aesthetic or functional problems. A wide range of accessories complements cases and trays to effectively organize their compartments and prevent damage to delicate parts and coatings during various sterilization steps.

- J2 Steel cassettes
- J4 Steel trays
- J8 Aluminum trays
- J12 Aluminum insert frames
- J14 Autoclave instrument protection lubricant
- J15 Sterilizing forceps
- J16 Endodontic boxes
- J18 Endodontic accessories
- J19 Bur holders
- J20 Accessories

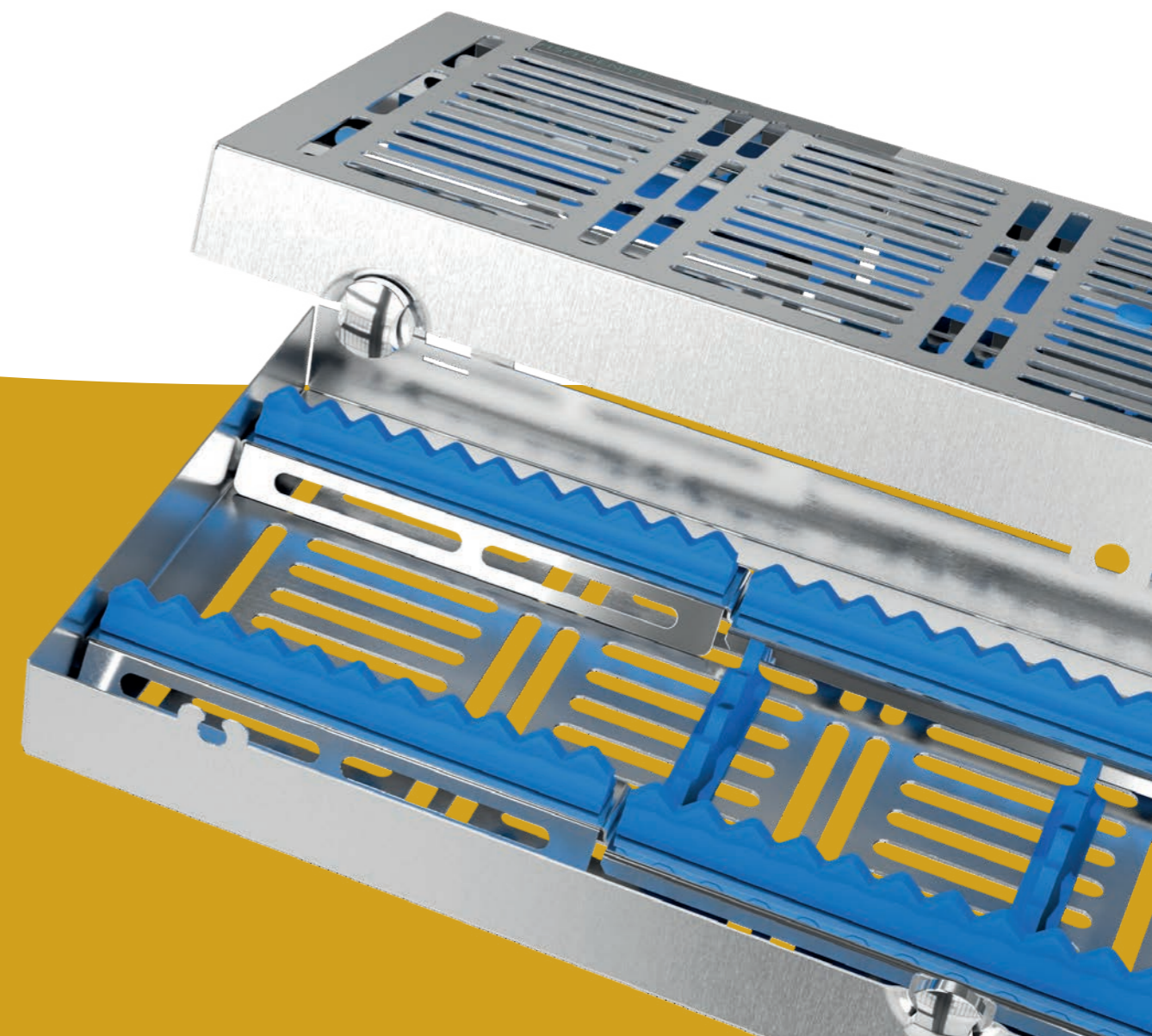

STAINLESS STEEL INSTRUMENT CASSETTES

LARGE

288x182x34 mm

Complete with a silicone insert frame for 20 instruments

Blue
2770-1

Orange
2770-1A

Red
2770-1R

Green
2770-1V

Lilac, Yellow, Green
2770-1MX



288x182x34 mm

Complete with a silicone insert frame for 15 instruments

Blue
2770-2

Orange
2770-2A

Red
2770-2R

Green
2770-2V



288x182x34 mm

Complete with a silicone insert frame for 10 instruments

Blue
2770-3

Orange
2770-3A

Red
2770-3R

Green
2770-3V



288x182x60 mm

Complete with a silicone insert frame for 20 instruments

Orange
2780-1A

Blue
2780-1B

Red
2780-1R

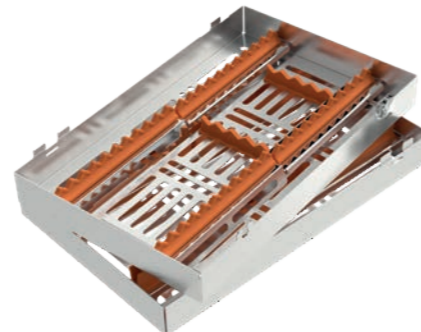

MEDIUM

182x144x34 mm

Complete with a silicone insert frame for 10 instruments

Blue
2771-1

Orange
2771-1A

Red
2771-1R

Green
2771-1V

Lilac
2771-1L

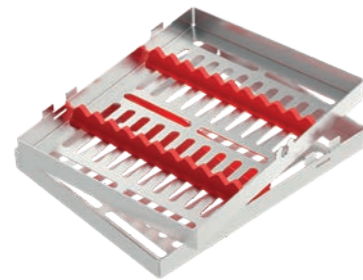

182x144x34 mm

Complete with a silicone insert frame for 5 instruments

Blue
2771-2

Orange
2771-2A

Red
2771-2R

Green
2771-2V



STAINLESS STEEL INSTRUMENT CASSETTES

MINI

182x72x34 mm

Complete with a silicone insert frame for 5 instruments

Blue
2772-1

Orange
2772-1A

Red
2772-1R

Green
2772-1V

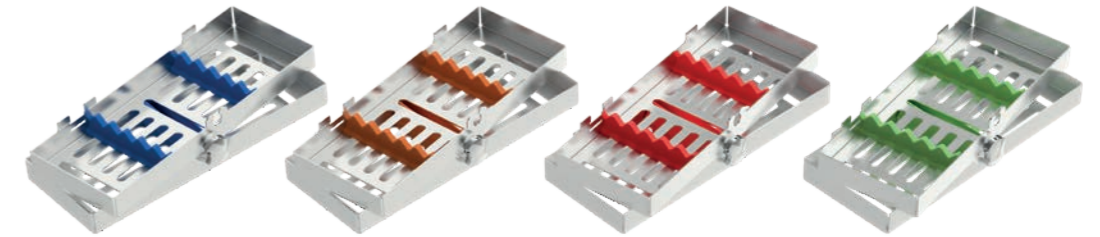

Silicone instrument holder with 10 slots

Blue
2770-G

Orange
2770-GA

Red
2770-GR

Green
2770-GV

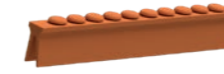

Silicone instrument holder with 5 slots

Blue
2771-G

Orange
2771-GA

Red
2771-GR

Green
2771-GV

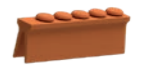

Silicone insert frame with 10 slots

Blue
2772-G

Orange
2772-GA

Red
2772-GR

Green
2772-GV



Silicone insert frame with 5 slots

Blue
2773-G

Orange
2773-GA

Red
2773-GR

Green
2773-GV



Set of 2 spare stainless steel knobs complete of washers



2774

#2 clips for locking trays, for scissors



2775

STAINLESS STEEL INSTRUMENT TRAYS

LARGE

288x187x39 mm

Instrument tray complete with a perforated base, perforated lid and insert frame

for 16 instruments
S2722-1

Instrument tray complete with a perforated base, perforated lid and insert frame

for 23 instruments
S2722-2

Perforated lid
288x187x29 mm
2721-U

Perforated base
284x183x17 mm
2721-L

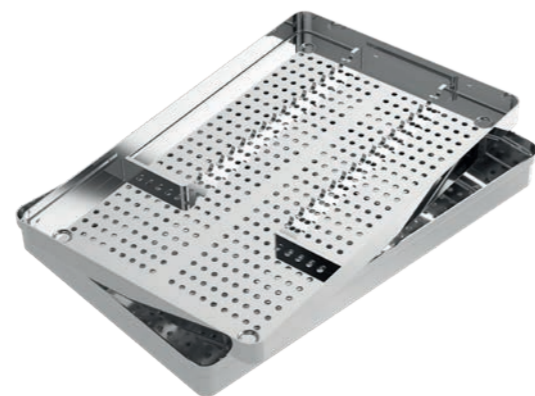

Instrument tray complete with a perforated base, non-perforated lid and insert frame

for 16 instruments
S2721-1

Instrument tray complete with a perforated base, non-perforated lid and insert frame

for 23 instruments
S2721-2

Non-perforated lid
288x187x29 mm
2720-U

Perforated base
284 x 183 x 17 mm
2721-L

STAINLESS STEEL INSTRUMENT TRAYS

LARGE

288x187x39 mm

Instrument tray complete with a non-perforated base, non-perforated lid and insert frame

for 16 instruments
S2720-1

Instrument tray complete with a non-perforated base, non-perforated lid and insert frame

for 23 instruments
S2720-2

Non-perforated lid
288x187x29 mm
2720-U

Non-perforated base
284x183x17 mm
2720-L

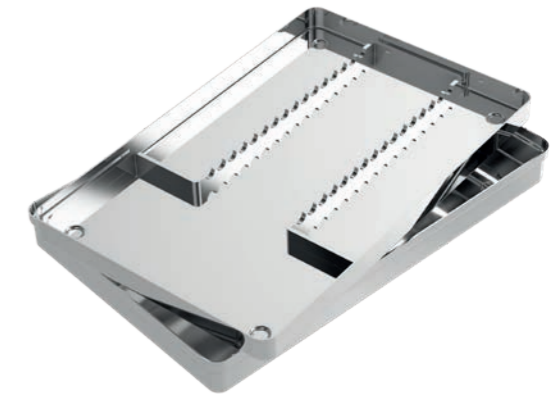

Stainless steel insert frame
for 16 instruments
2730-1

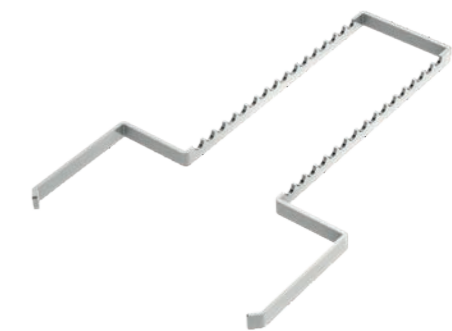

Stainless steel insert frame
for 23 instruments
2730-2

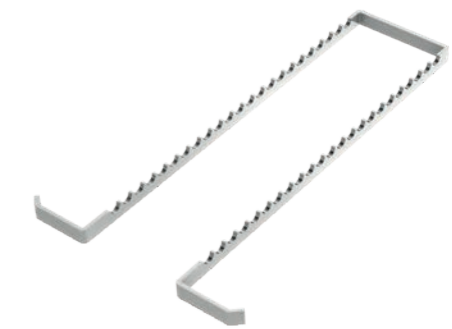

STAINLESS STEEL INSTRUMENT TRAYS

MEDIUM

200x100x30 mm

Instrument tray complete with perforated base, perforated lid and insert frame

for 7 instruments
S2702

Perforated lid
200x100x10 mm

2702-U

Perforated base
200x100x30 mm

2702-L

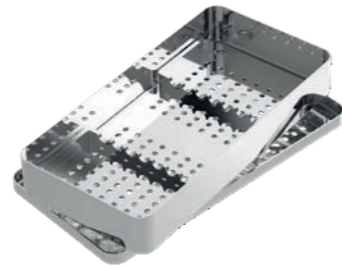

Instrument tray complete with non-perforated base, non-perforated lid and insert frame

for 7 instruments
S2700

Non-perforated lid
200x100x10 mm

2700-U

Non-perforated base
200x100x30 mm

2700-L



Stainless steel insert frame

for 7 instruments
2700-G



MEDIUM

187x144x39 mm

Instrument tray complete with perforated base, perforated lid and insert frame

for 8 instruments
S2723-1

Instrument tray complete with perforated base, perforated lid and insert frame

for 4 instruments
S2723-2

Perforated lid
187x144x29 mm

2723-U

Perforated base
183x142x17 mm

2723-L

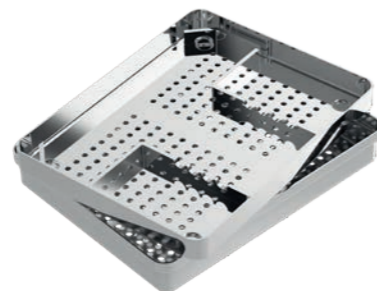
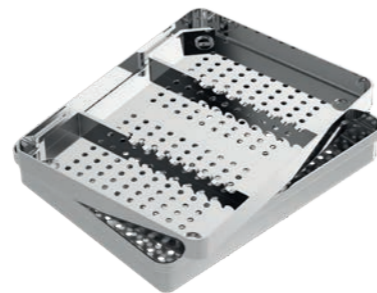

STAINLESS STEEL INSTRUMENT TRAYS

MEDIUM

187x144x39 mm

Instrument tray complete with non-perforated base, non-perforated lid and insert frame

for 8 instruments
S2724-1

Instrument tray complete with non-perforated base, lid and insert frame

for 4 instruments
S2724-2

Non-perforated lid
187x144x29 mm

2724-U

Non-perforated base
183x142x17 mm

2724-L



Stainless steel insert frame

for 8 instruments
2730-4



Stainless steel insert frame

for 4 instruments
2730-5

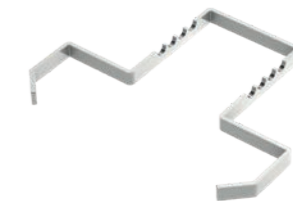

ANODIZED ALUMINUM COLOR-CODED INSTRUMENT TRAYS

LARGE
284x183x17 mm

Light blue
AL2720-LC

Red
AL2720-LR

Gold
AL2720-LO

Green
AL2720-LV

Silver
AL2720-LA

Lid
288x187x29 mm

Silver
AL2720-UA

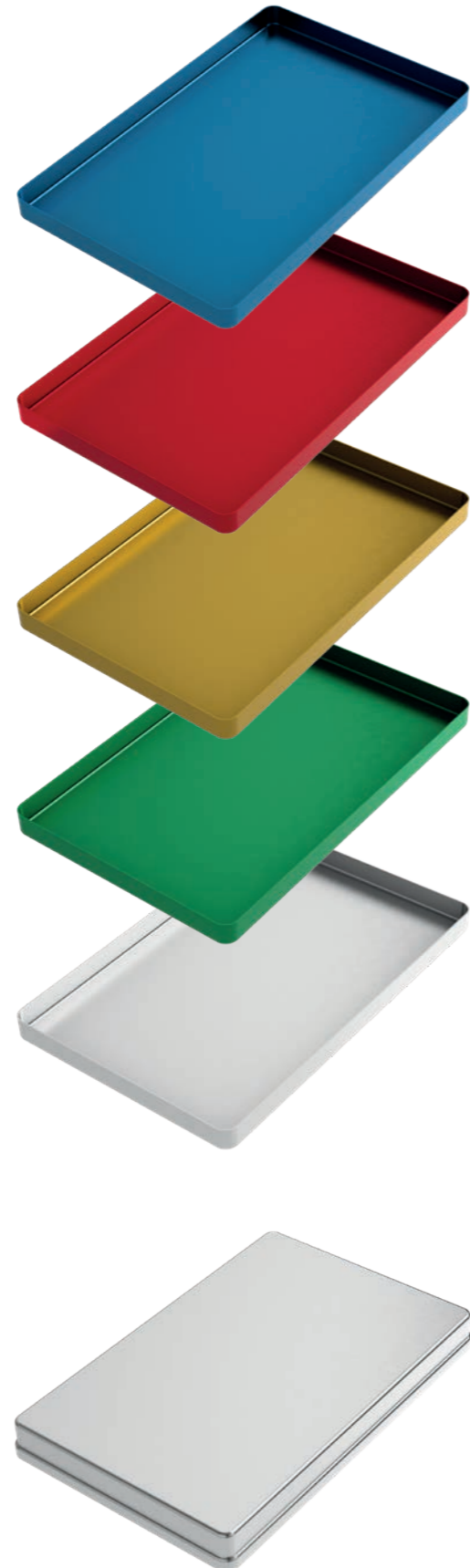

ANODIZED ALUMINUM COLOR-CODED INSTRUMENT TRAYS - PERFORATED

LARGE
284x183x17 mm

Light blue
AL2721-LC

Red
AL2721-LR

Gold
AL2721-LO

Green
AL2721-LV

Silver
AL2721-LA

Lid
288x187x29 mm

Silver
AL2721-UA

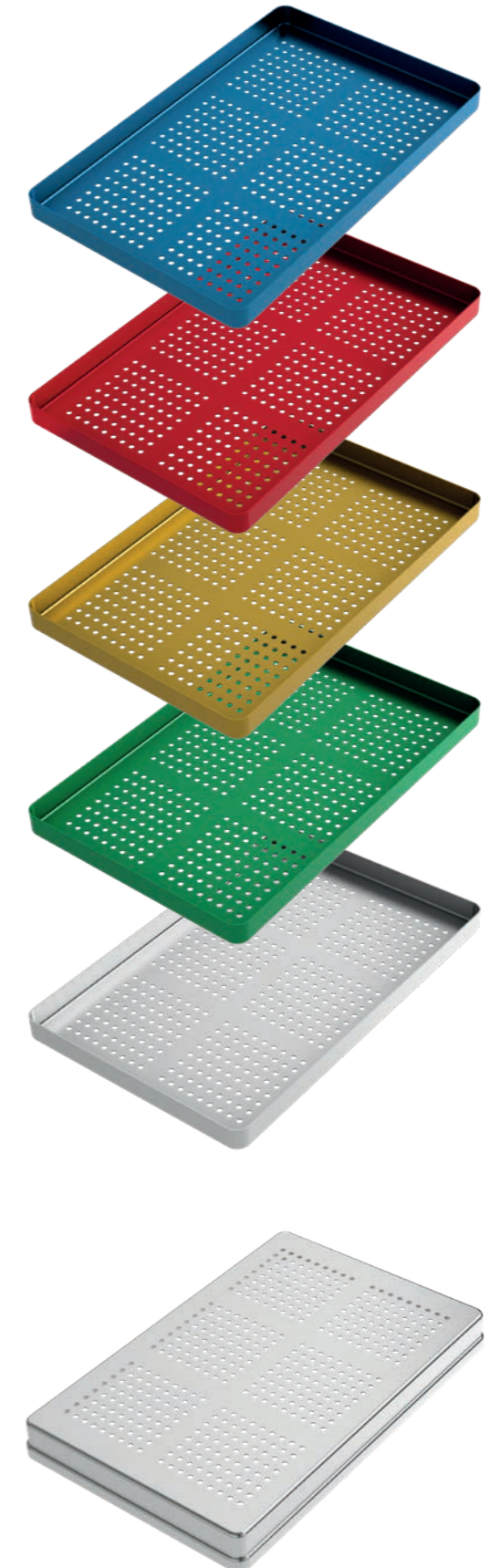

ANODIZED ALUMINUM COLOR-CODED INSTRUMENT TRAYS

MEDIUM
142x183x17 mm

Light blue
AL2722-LC

Red
AL2722-LR

Gold
AL2722-LO

Green
AL2722-LV

Silver
AL2722-LA



Lid
144x187x29 mm

Argento
AL2722-UA



ANODIZED ALUMINUM COLOR-CODED INSTRUMENT TRAYS

MINI
100x180x11 mm

Light blue
AL2723-LC

Red
AL2723-LR

Gold
AL2723-LO

Green
AL2723-LV

Silver
AL2723-LA

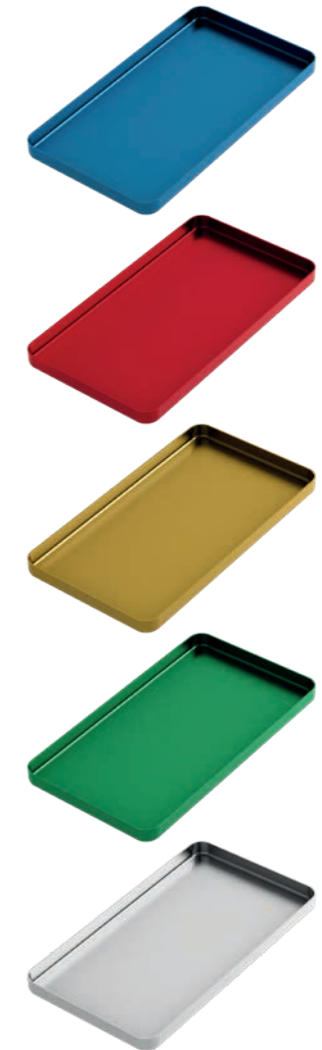

Lid
103x182x10 mm

Argento
AL2723-UA



ALUMINUM INSERT FRAMES

ALUMINUM INSERT FRAMES

Compatible exclusively with the AL2722 trays

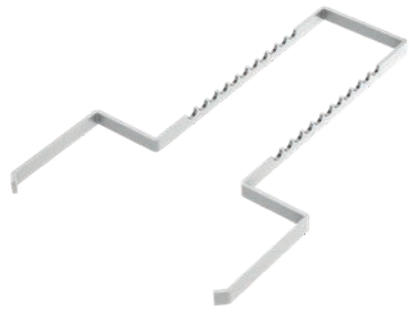

for 11 instruments
AL2730-1

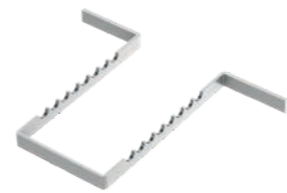

for 8 instruments
AL2731-1



for 17 instruments
AL2730-2



for 4 instruments
AL2731-2

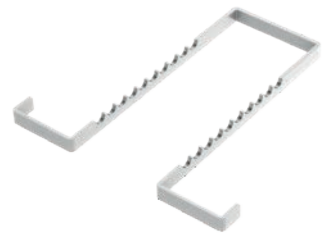

for 10 instruments
AL2730-3



for 11 instruments
AL2730-4



AL2722-LA
aluminum instrument
trays for operating
procedures



STAINLESS STEEL TRAYS

MAXI
200x150 mm



2737-1



2737-2

Stainless steel kidney dish



2737-3
170x100x35 mm



2737-4
250x140x40 mm

PLIER TRAY

STANDARD
Stainless steel plier tray



S5800

AUTOClave INSTRUMENT PROTECTION LUBRICANT

Maximum protection of instruments in the autoclave. Penetrates and lubricates all instrument joints. Protects all dental and surgical instruments before and after sterilization.

Instructions for use:
oil all instrument tips, joints and fastenings before and after sterilization.



Steril Oil
40 ml
8002

Special lubricant for dental and surgical instruments. Lubricates the joints of scissors, hemostatic and extracting forceps, bone rongeurs, needle holders etc., before and after sterilization. Does not dry out during sterilization. Provides protection from corrosion and other deposits and ensures proper operation of the instruments.



Silicone
40 ml
8010

ANODIZED ALUMINUM CONTAINERS FOR INSTRUMENT TRAYS



AL2724-1
49x26x10 mm



AL2724-2
49x26x10 mm



AL2724-3
59x49x10 mm



AL2724-4
59x49x10 mm

INSTRUMENT TRAY RACK IN ALUMINUM

STANDARD
300x190x270 mm



6 compartments
AL2739-1

MEDIUM
160x190x270 mm



6 compartments
AL2739-2

STERILIZING FORCEPS

20 cm
0565-1



30 cm
0565-2



ENDODONTIC BOXES

Anodized aluminum endodontic boxes with a lid

MAXI

204x105x54 mm



AL2740-1



AL2740-2



AL2740-3

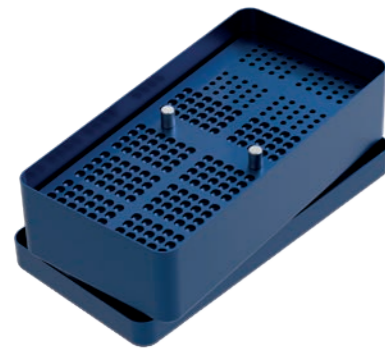

AL2740-4



AL2740-5

MEDIUM

125x105x54 mm



AL2741-1



AL2741-2

Spare glasses for endo-box



AL2740-R

ENDODONTIC BOXES

Anodized aluminum endodontic boxes with a lid

MINI

100x44x54 mm



AL2742-1



AL2742-2

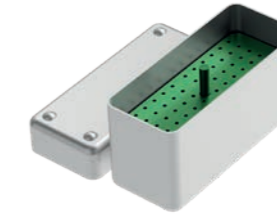

AL2742-3



AL2742-4



AL2742-5



AL2742-6



AL2742-7

Round anodized aluminum endodontic boxes with a lid



AL2744
Ø 48 mm - h. 62 mm



AL2743
Ø 94 mm - h. 70 mm



AL2740-R

Spare glasses for endo-box

ENDODONTIC ACCESSORIES

Aluminum endodontic tray
with a lid
257x116x16 mm



AL2725

Anodized aluminum endodontic instrument cleaners
Ø 40 mm - h. 30 mm



AL2746-1



AL2746-2

Endometers in anodized aluminum
100x40x40 mm

Ø 34 mm - h. 48 mm

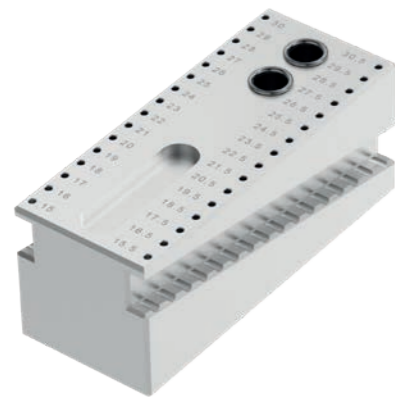

AL2747-1A



AL2745-1A



AL2745-2C

BUR HOLDERS



with 7 bur holders, with lid
AL2763-1



with 2 bur holders
AL2763-2

Autoclavable

Non-toxic food-grade silicon. The plastic cover is not autoclavable.

- Insertion of turbine burs and micromotor burs in one bur holder box.
- Color-coded operating sets, optimizing surgery, storage and selection times.
- cross holes in the silicone bur holders prevent burs from falling out and breaking.

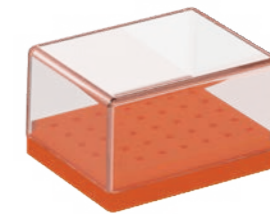

Orange
S2760-A

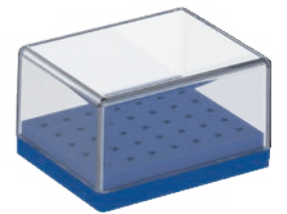

Blue
S2760-C

Aluminum

Suitable for steam sterilizing

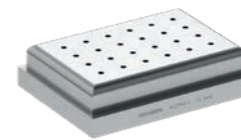

with rim, 24 FG holes
AL2760-1
(small burs)



with rim, 24 CA holes
AL2760-2
(big burs)

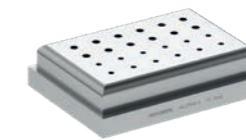

With rim, 24 FG/CA holes
AL2760-3
(small and big burs)



AL2760-U
lid

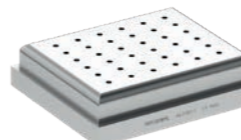

With rim, 36 FG holes
AL2761-1
(small burs)

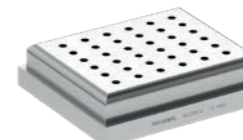

With rim, 36 CA holes
AL2761-2
(big burs)

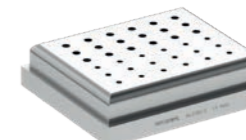

With rim, 36 FG/CA holes
AL2761-3
(small and big burs)



AL2761-U
lid for AL2761-1, 2, 3
and for silicon bur holder



48 FG holes
AL2762-1
(small burs)



48 CA holes
AL2762-2
(big burs)



48 FG/CA holes
AL2762-3
(small big burs)

ACCESSORIES

Anodized aluminum waste container

sterilizable
available in 5 colors
Ø 7 x h. 7,5 cm



AL2764-A AL2764-C AL2764-O AL2764-R AL2764-V

Anodized aluminum cotton dispensers

with an internal spring
sterilizable
available in 5 colors
Ø 7 x h. 7,5 cm

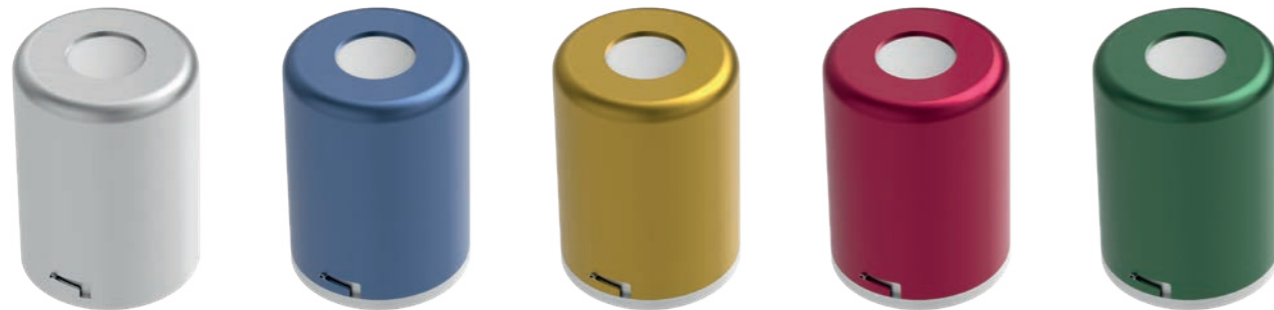

AL2765-A AL2765-C AL2765-O AL2765-R AL2765-V

Disposable waste bins

1000 pcs / box



AL2767-1

Aluminum base

for waste bins



AL2767-2

ACCESSORIES

Plastic box for used needles



AL2766

Stainless steel cotton pellet dispenser

40x40x50 mm



2751-1

Stainless steel alcohol burner with a wick



3101

Spare wick

15 cm



3101-1

IMPRESSION TRAYS

MADE IN ITALY

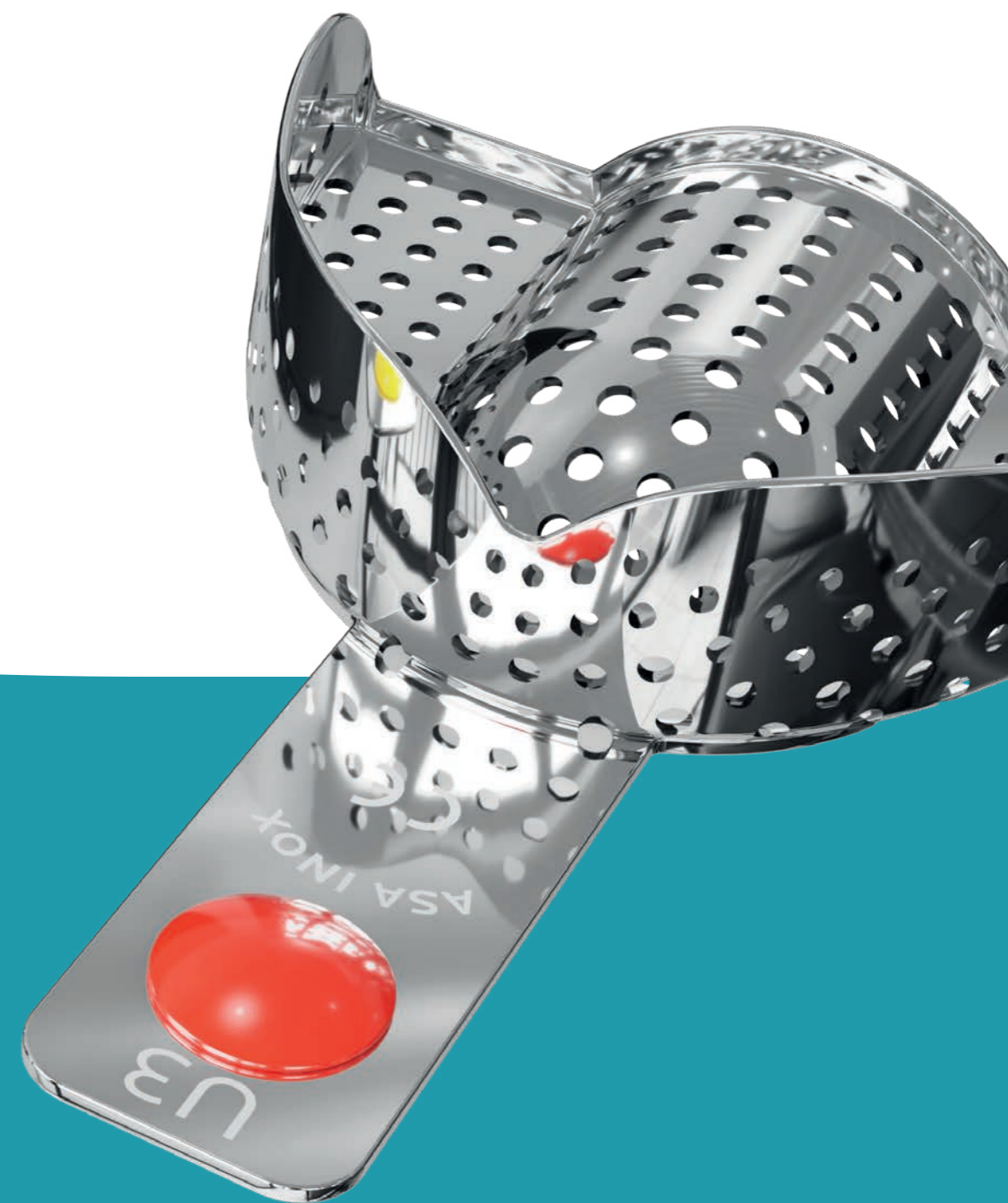
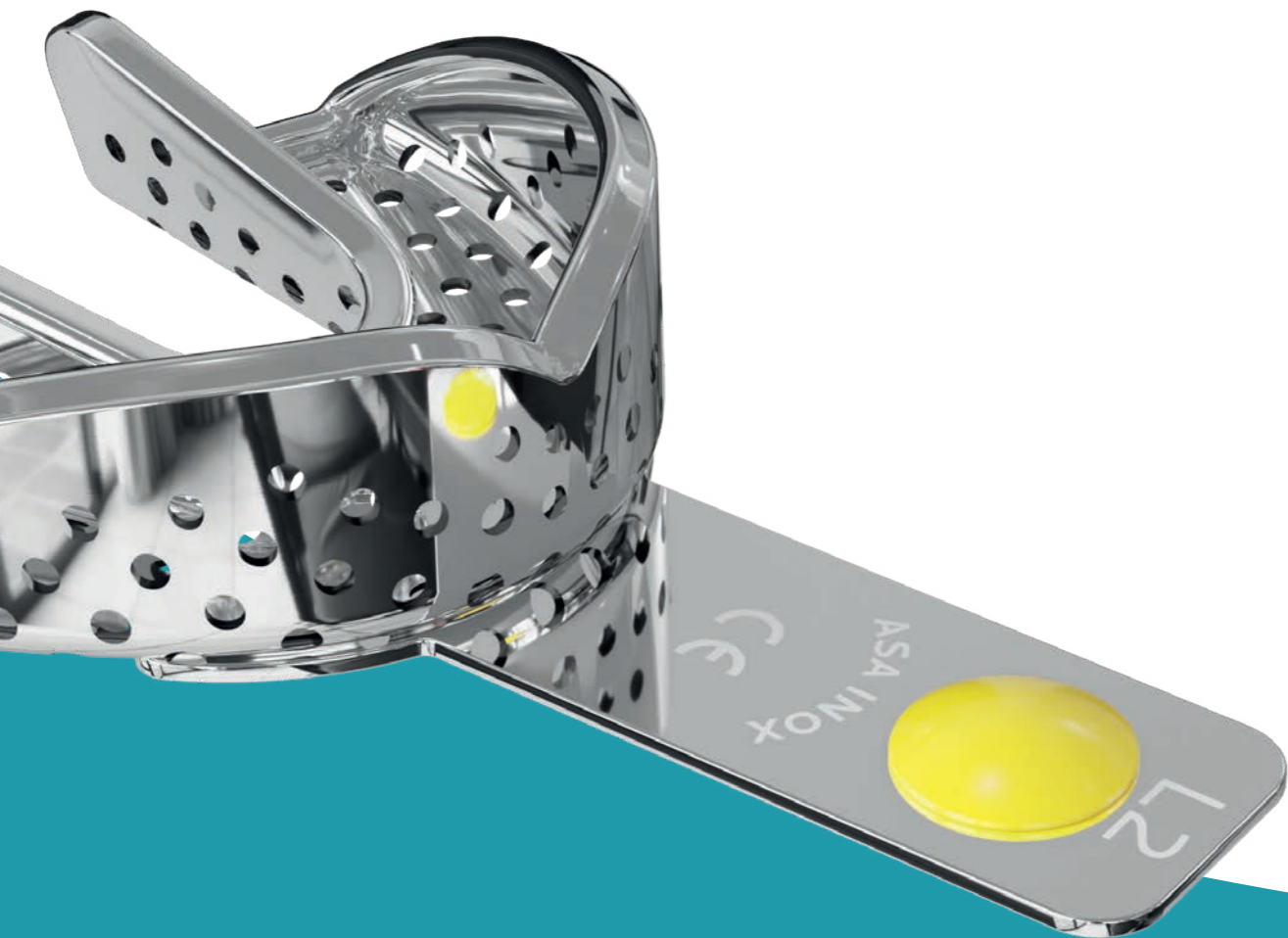

K4 Perforated, steel

K22 Non-perforated, steel

K38 Perforated, aluminum

K44 Partial occlusal

K45 For children, aluminum

K46 Polycarbonate

A GREAT FIRST IMPRESSION

Correctly created impressions are of primary importance to obtain optimal results from the start.

Choosing the wrong size or the incorrect shape usually leads to an inadequate impression: restorations and prosthesis can give rise to poor or improper occlusion, thereby requiring additional hours of work and higher costs.

Asa Dental impression trays come in different shapes and materials, with a convenient color indexing system for easy size selection, and all the necessary dimensional accuracy that is key to a perfect outcome.

IMPRESSION TRAYS PARTS

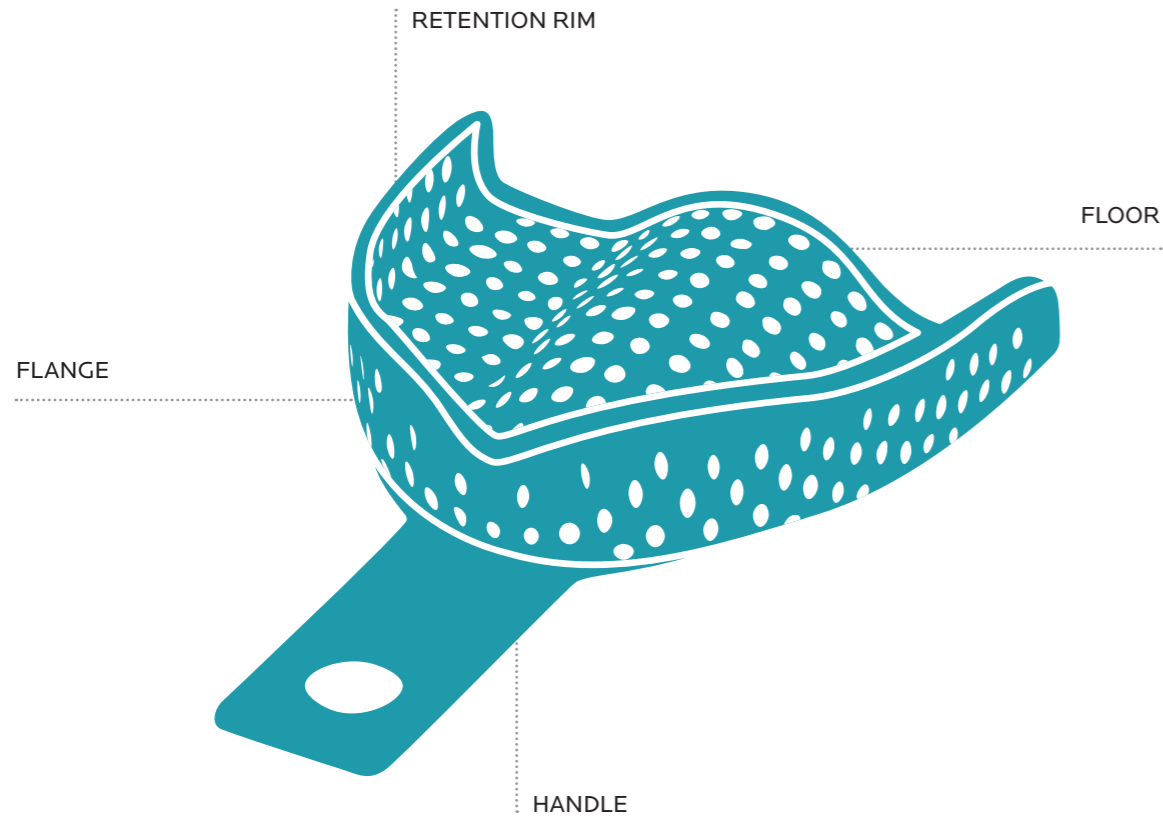

COLOR INDEX

ASA Codicolor

- U1/L1
XXS
- U2/L2
XS
- U3/L3
S
- U4/L4
M
- U5/L5
L
- U6/L6
XL



TRAY SELECTOR

Materials	Impression Technique					
	Monophase 2 materials	Monophase 1 material	Bi-phase	Impression with a border	Half arch	Sandwich
Silicone	2802 2803 2807	2880	2800 2801 2804 2804S 2808 2809 2811 2813 2814 2806		2819	2819 2803S
Alginate	2804S 2813	2851 2852 2804 2801 2800 2814	2806 2851	2851		
Polyether/ Polysulfide	2802 2803 2807	2802 2803 2803S 2807 2810				2807S 2810

Legend

2880: ideal
2807: compatible

TYPES OF IMPRESSION TRAYS

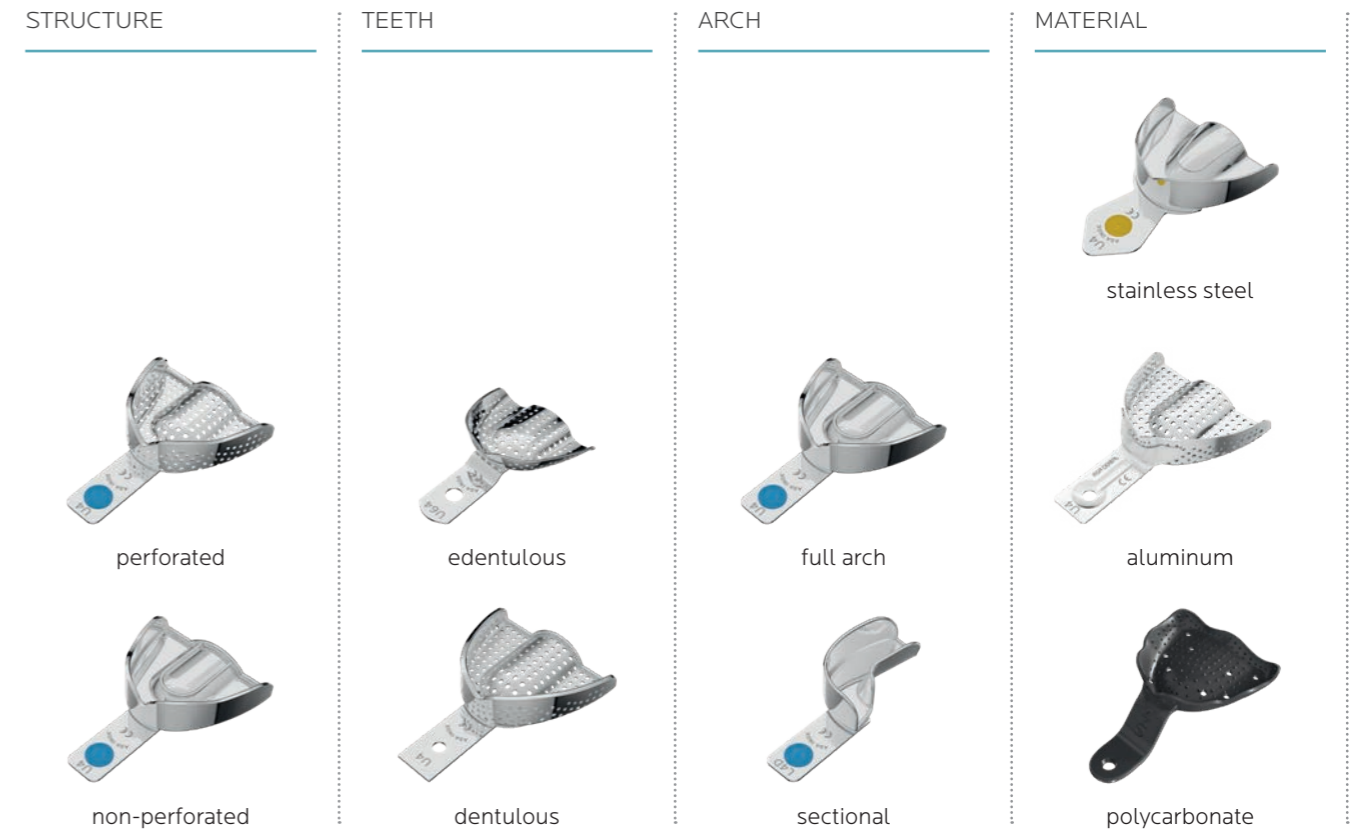

PERFORATED STAINLESS STEEL IMPRESSION TRAYS - PERMA-LOCK
with retention rim



ASA Codicolor

- U1/L1
XXS
- U2/L2
XS
- U3/L3
S
- U4/L4
M
- U5/L5
L
- U6/L6
XL

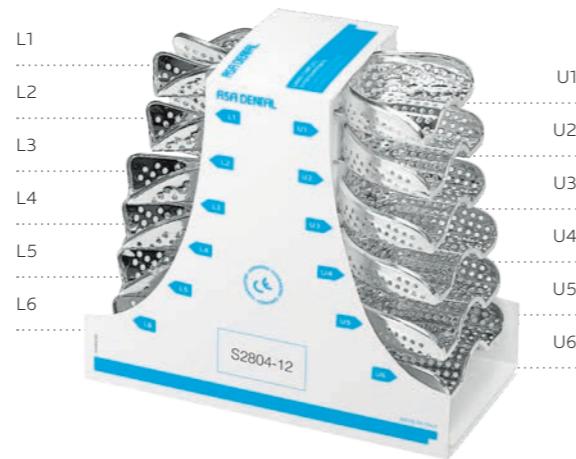

S2804-12
set of 12



S2804-8
set of 8



S2804-6
set of 6

PERFORATED STAINLESS STEEL IMPRESSION TRAYS - PERMA-LOCK
with retention rim

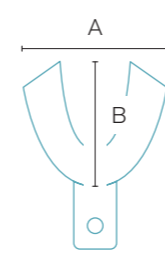

2804 Lower

		A (mm)	B (mm)
L1	XXS	55	47
L2	XS	60	49
L3	S	72	54
L4	M	74	57
L5	L	76	59
L6	XL	78	61

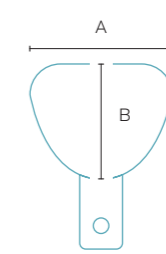

2804 Upper

		A (mm)	B (mm)
U1	XXS	61	47
U2	XS	64	51
U3	S	66	53
U4	M	69	57
U5	L	71	60
U6	XL	73	62

Lower



2804-L1



2804-L2



2804-L3



2804-L4



2804-L5



2804-L6

Upper



2804-U1



2804-U2



2804-U3



2804-U4



2804-U5



2804-U6

Partial



2804-L1P



2804-L2D



2804-L3D



2804-L4D



2804-L5D



2804-L6D

Partial



2804-U1P



2804-U2S



2804-U3S



2804-U4S



2804-U5S



2804-U6S

PERFORATED STAINLESS STEEL IMPRESSION TRAYS - PERMA-LOCK ANATOMIC

with retention rim



ASA Codicolor

- U1/L1
XXS
- U2/L2
XS
- U3/L3
S
- U4/L4
M
- U5/L5
L
- U6/L6
XL

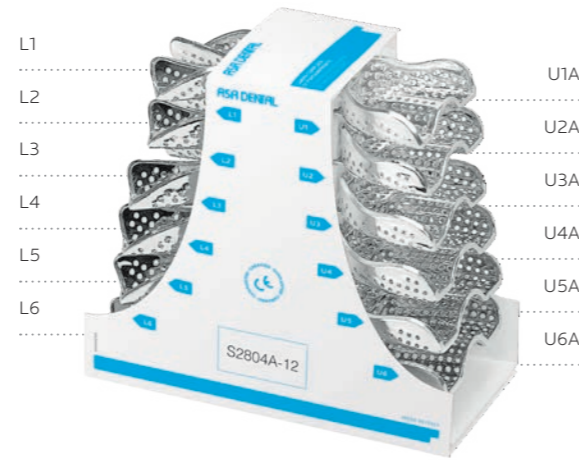

S2804A-12
set of 12



S2804A-8
set of 8



S2804A-6
set of 6

PERFORATED STAINLESS STEEL IMPRESSION TRAYS - PERMA-LOCK ANATOMIC

with retention rim

2804 Lower

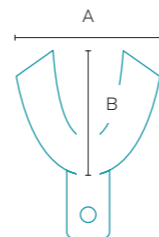

		A (mm)	B (mm)
L1	XXS	55	47
L2	XS	60	49
L3	S	72	54
L4	M	74	57
L5	L	76	59
L6	XL	78	61

2804A Upper

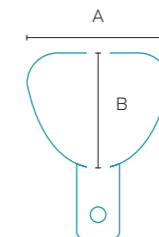

		A (mm)	B (mm)
U1A	XXS	61	47
U2A	XS	64	51
U3A	S	66	53
U4A	M	69	57
U5A	L	71	60
U6A	XL	73	62

Lower



Upper

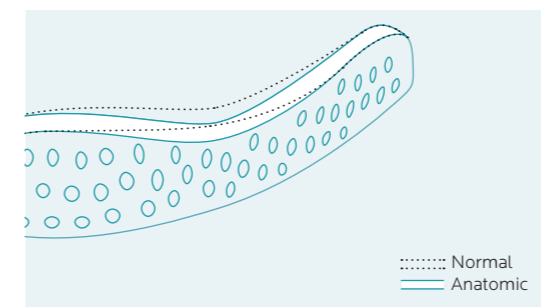

PERFORATED STAINLESS STEEL IMPRESSION TRAYS - PERMA-LOCK HIGH GRIP

with increased retention rim and internal high grip satin finish



S2804S-12
set of 12



S2804S-8
set of 8



S2804S-6
set of 6

PERFORATED STAINLESS STEEL IMPRESSION TRAYS - PERMA-LOCK HIGH GRIP

with increased retention rim and internal high grip satin finish

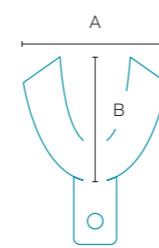

2804S Lower

		A (mm)	B (mm)
L1	XXS	55	47
L2	XS	60	49
L3	S	72	54
L4	M	74	57
L5	L	76	59
L6	XL	78	61

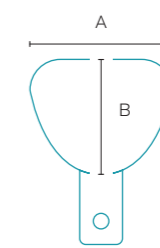

2804S Upper

		A (mm)	B (mm)
U1	XXS	61	47
U2	XS	64	51
U3	S	66	53
U4	M	69	57
U5	L	71	60
U6	XL	73	62

Lower



Upper

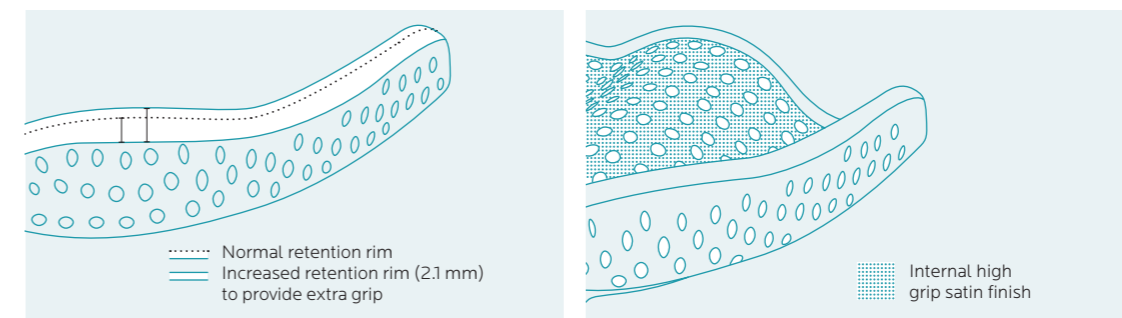

..... Normal retention rim
 ——— Increased retention rim (2.1 mm)
 to provide extra grip

Internal high grip satin finish

PERFORATED STAINLESS STEEL IMPRESSION TRAYS - ANTERIOR DEPRESSED

with retention rim



2809 Lower

		A (mm)	B (mm)
L22	S	76	54
L21	M	79	57
L20	L	81	60

2809 Upper

		A (mm)	B (mm)
U7	S	70	57
U4	M	71	64
U1	L	81	67

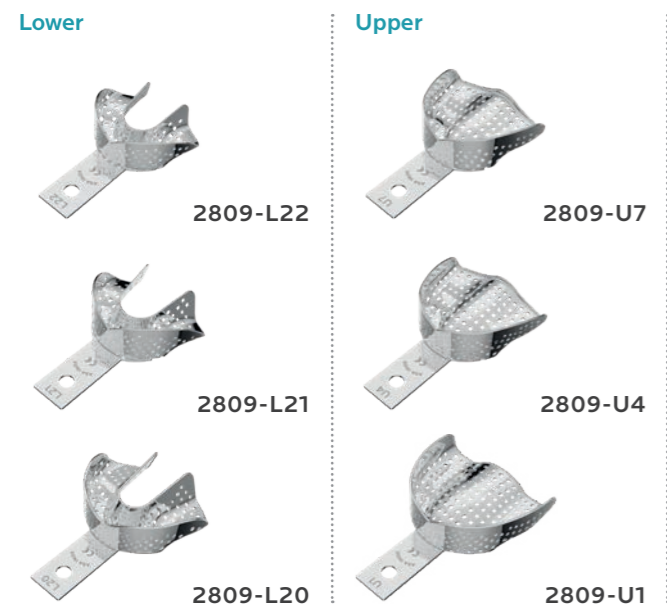

S2809-6
set of 6

PERFORATED STAINLESS STEEL IMPRESSION TRAYS - EDENTULOUS

with retention rim



2806 Lower

		A (mm)	B (mm)
L69	S	70	57
L68	M	73	60
L67	NL	70	64
L66	L	86	64

NL: Narrow Large

2806 Upper

		A (mm)	B (mm)
U64	S	73	60
U63	NM	70	64
U62	M	76	67
U61	L	79	70

NM: Narrow Medium

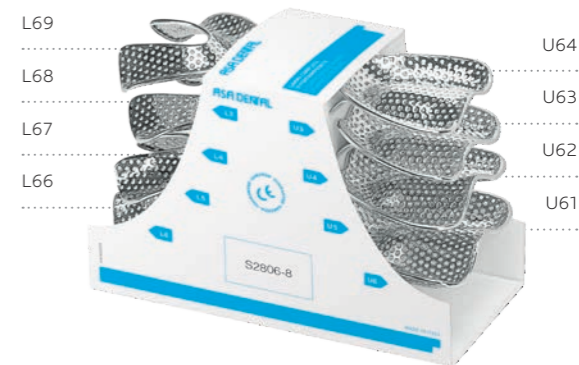
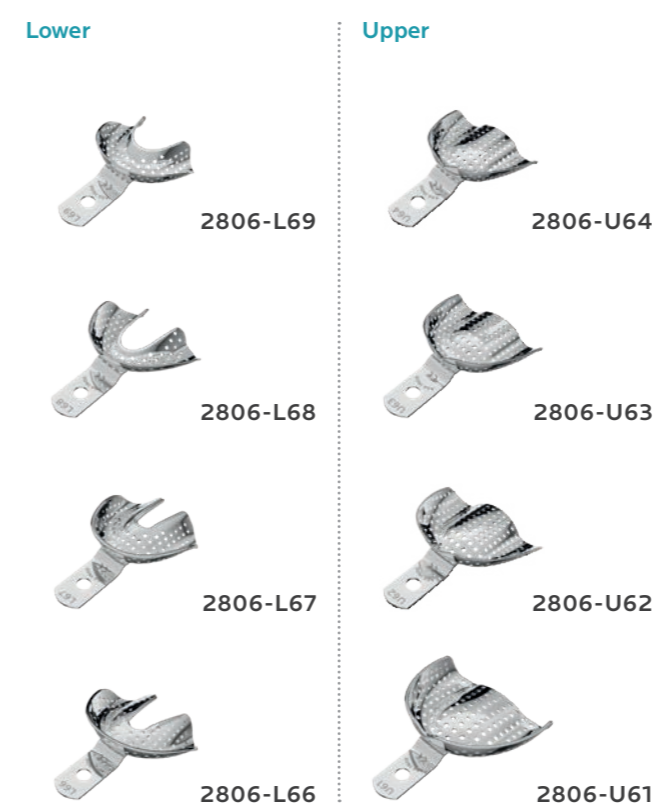

S2806-8
set of 8

PERFORATED STAINLESS STEEL IMPRESSION TRAYS

without retention rim

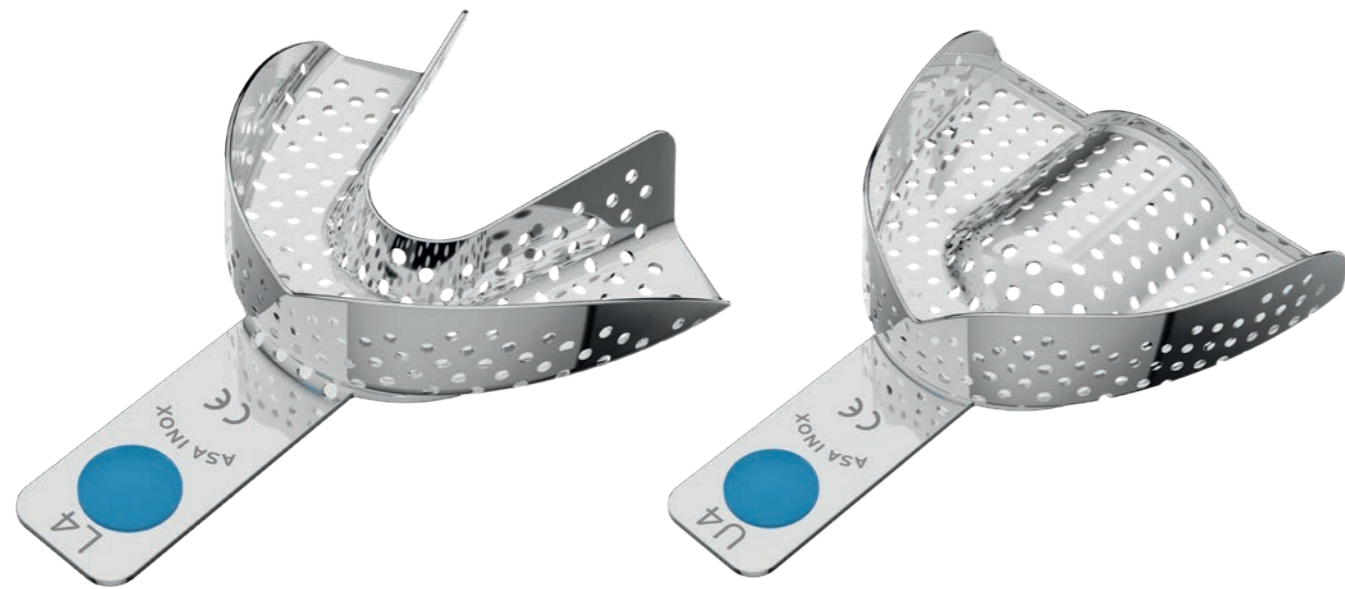

ASA Codicolor

- U1/L1
XXS
- U2/L2
XS
- U3/L3
S
- U4/L4
M
- U5/L5
L
- U6/L6
XL

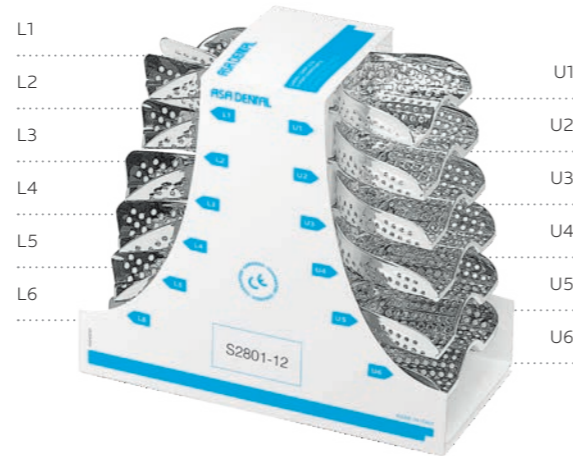

S2801-12
set of 12



S2801-8
set of 8



S2801-6
set of 6

PERFORATED STAINLESS STEEL IMPRESSION TRAYS

without retention rim

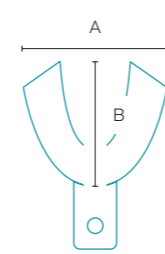

2801 Lower

		A (mm)	B (mm)
L1	XXS	55	47
L2	XS	60	49
L3	S	72	54
L4	M	74	57
L5	L	76	59
L6	XL	78	61

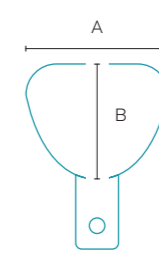

2801 Upper

		A (mm)	B (mm)
U1	XXS	61	47
U2	XS	64	51
U3	S	66	53
U4	M	69	57
U5	L	71	60
U6	XL	73	62

Lower

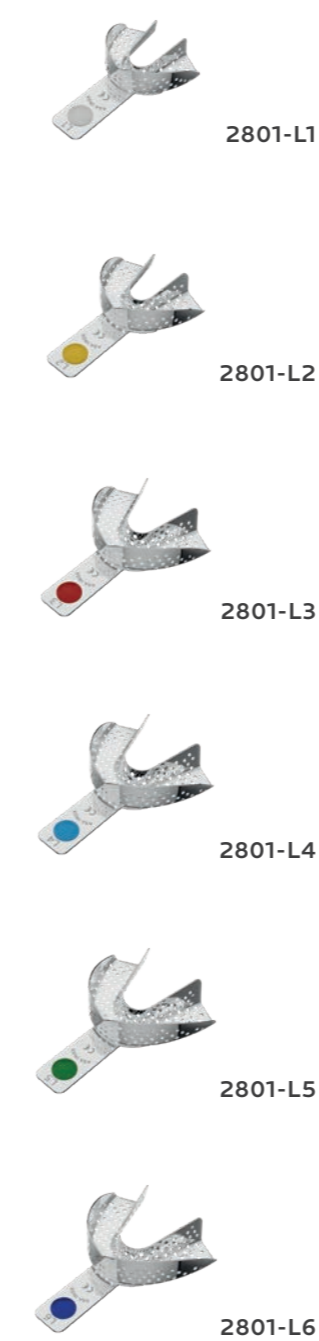

Upper



Partial



Partial



PERFORATED STAINLESS STEEL IMPRESSION TRAYS - ANATOMIC

without retention rim



ASA Codicolor

- U1/L1
XXS
- U2/L2
XS
- U3/L3
S
- U4/L4
M
- U5/L5
L
- U6/L6
XL



S2801A-12
set of 12



S2801A-8
set of 8



S2801A-6
set of 6

PERFORATED STAINLESS STEEL IMPRESSION TRAYS - ANATOMIC

without retention rim

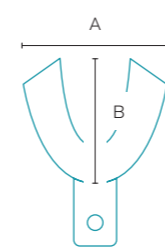

2801 Lower

		A (mm)	B (mm)
L1	XXS	55	47
L2	XS	60	49
L3	S	72	54
L4	M	74	57
L5	L	76	59
L6	XL	78	61

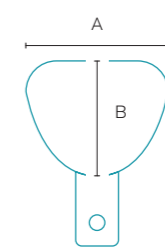

2801 Upper

		A (mm)	B (mm)
U1	XXS	61	47
U2	XS	64	51
U3	S	66	53
U4	M	69	57
U5	L	71	60
U6	XL	73	62

Lower



Upper

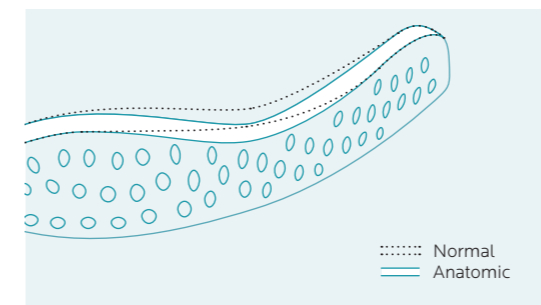

PERFORATED STAINLESS STEEL IMPRESSION TRAYS - EHRICKE

without retention rim



2811-UB Lower

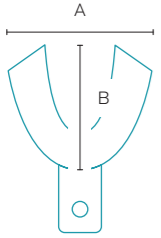

	A (mm)	B (mm)
2811-UB0	65	46
2811-UB1	67	50
2811-UB2	76	54
2811-UB3	79	56
2811-UB4	79	61

for lower jaws, for children

2811-OB Upper

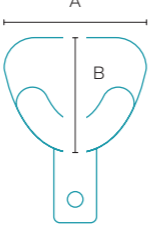

	A (mm)	B (mm)
2811-OB0	59	52
2811-OB1	66	52
2811-OB2	71	62
2811-OB3	71	64
2811-OB4	80	70

for upper jaws, for children



S2811-1
set of 10



S2811-2
set of 6

PERFORATED STAINLESS STEEL IMPRESSION TRAYS - EHRICKE

without retention rim

Lower



Upper



2811-BS Upper

	A (mm)	B (mm)
2811-BS2	70	54

for narrow upper jaws



2811-BS2

PERFORATED STAINLESS STEEL IMPRESSION TRAYS - EHRICKE

without retention rim



2811-UU Lower

	A (mm)	B (mm)
2811-UU1	70	48
2811-UU2	70	53
2811-UU3	72	57

for edentulous lower jaws

2811-OU Upper

	A (mm)	B (mm)
2811-OU1	64	46
2811-OU2	68	53
2811-OU3	79	61

for edentulous upper jaws

Lower

Upper



S2811-3
set of 10

PERFORATED STAINLESS STEEL IMPRESSION TRAYS - EHRICKE

without retention rim



2811-UP Lower

	A (mm)	B (mm)
2811-UP1	70	55
2811-UP2	78	59

for partially toothed lower jaws

2811-OP Upper

	A (mm)	B (mm)
2811-OP1	62	50
2811-OP2	70	56

for partially toothed upper jaws

Lower

Upper

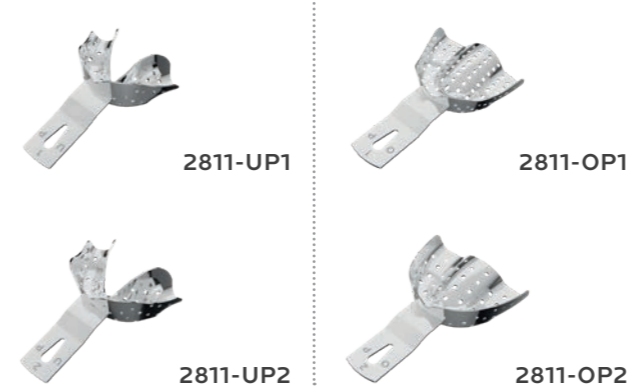

S2811-4
set of 8

PERFORATED STAINLESS STEEL IMPRESSION TRAYS - EDENTULOUS

without retention rim

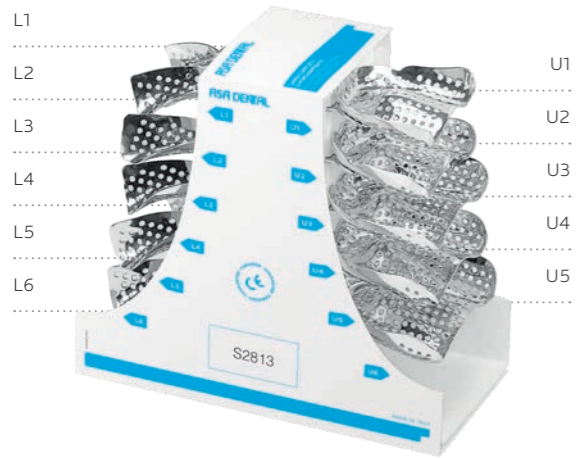

S2813
set of 11 and compass
for final impressions



MB026-1
stainless steel compass

PERFORATED STAINLESS STEEL IMPRESSION TRAYS - EDENTULOUS

without retention rim

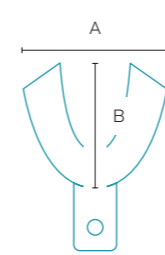

2813 Lower

		A (mm)	B (mm)
L1	XXS	60	54
L2	XS	67	55
L3	S	70	56
L4	M	74	58
L5	L	76	60
L6	XL	80	62

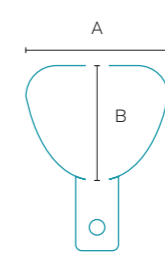

2813 Upper

		A (mm)	B (mm)
U1	XXS	60	50
U2	XS	64	54
U3	S	68	58
U4	M	70	60
U5	L	78	64

Lower



2813-L1



2813-L2



2813-L3



2813-L4



2813-L5



2813-L6

Upper



2813-U1



2813-U2



2813-U3



2813-U4



2813-U5

NON-PERFORATED STAINLESS STEEL IMPRESSION TRAYS - NEW SUPER

with retention rim



NON-PERFORATED STAINLESS STEEL IMPRESSION TRAYS - NEW SUPER

with retention rim

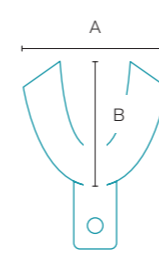

2803 Lower

		A (mm)	B (mm)
L5	XS	69	50
L4	S	72	57
L3	M	76	57
L2	L	78	59
L1	XL	80	63

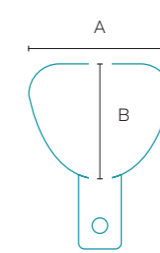

2803 Upper

		A (mm)	B (mm)
U5	XS	65	51
U4	S	67	53
U3	M	71	55
U2	L	74	60
U1	XL	81	63

Lower



2803-L5



2803-L4



2803-L3



2803-L2



2803-L1

Upper



2803-U5



2803-U4



2803-U3



2803-U2



2803-U1

ASA Codicolor

- U5/L5
XXS
- U4/L4
XS
- U3/L3
S
- U2/L2
M
- U1/L1
L



S2803-10
set of 10

NON-PERFORATED STAINLESS STEEL IMPRESSION TRAYS - PERMA-LOCK

with retention rim



ASA Codicolor

- U1/L1
XXS
- U2/L2
XS
- U3/L3
S
- U4/L4
M
- U5/L5
L
- U6/L6
XL



S2807-12
set of 12



S2807-8
set of 8



S2807-6
set of 6

NON-PERFORATED STAINLESS STEEL IMPRESSION TRAYS - PERMA-LOCK

with retention rim

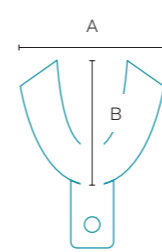

2807 Lower

		A (mm)	B (mm)
L1	XXS	55	47
L2	XS	60	49
L3	S	72	54
L4	M	74	57
L5	L	76	59
L6	XL	78	61

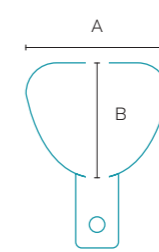

2807 Upper

		A (mm)	B (mm)
U1	XXS	61	47
U2	XS	64	51
U3	S	66	53
U4	M	69	57
U5	L	71	60
U6	XL	73	62

Lower

Upper

Partial

Partial



2807-L1



2807-U1



2807-L1P



2807-U1P



2807-L2



2807-U2



2807-L2D



2807-L2S



2807-L3



2807-U3



2807-L4



2807-U4



2807-L4D



2807-L4S



2807-L5



2807-U5



2807-L6



2807-U6



2807-L6D



2807-L6S

NON-PERFORATED STAINLESS STEEL IMPRESSION TRAYS - PERMA-LOCK ANATOMIC

with retention rim



ASA Codicolor

- U1/L1
XXS
- U2/L2
XS
- U3/L3
S
- U4/L4
M
- U5/L5
L
- U6/L6
XL



S2807A-12
set of 12



S2807A-8
set of 8



S2807A-6
set of 6

NON-PERFORATED STAINLESS STEEL IMPRESSION TRAYS - PERMA-LOCK ANATOMIC

with retention rim

2807 Lower

		A (mm)	B (mm)
L1	XXS	55	47
L2	XS	60	49
L3	S	72	54
L4	M	74	57
L5	L	76	59
L6	XL	78	61

2807 Upper

		A (mm)	B (mm)
U1A	XXS	61	47
U2A	XS	64	51
U3A	S	66	53
U4A	M	69	57
U5A	L	71	60
U6A	XL	73	62

Lower



Upper

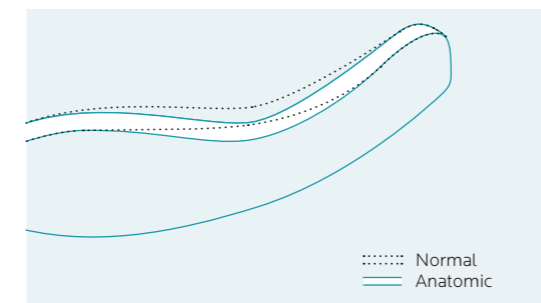

NON-PERFORATED STAINLESS STEEL IMPRESSION TRAYS - PERMA-LOCK HIGH GRIP

with increased retention rim and internal high grip satin finish



S2807S-12
set of 12



S2807S-8
set of 8



S2807S-6
set of 6

NON-PERFORATED STAINLESS STEEL IMPRESSION TRAYS - PERMA-LOCK HIGH GRIP

with increased retention rim and internal high grip satin finish

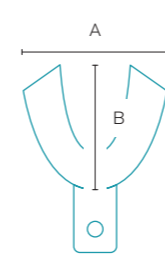

2807S Lower

		A (mm)	B (mm)
L1	XXS	55	47
L2	XS	60	49
L3	S	72	54
L4	M	75	57
L5	L	76	59
L6	XL	78	61

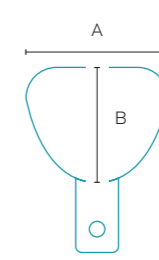

2807S Upper

		A (mm)	B (mm)
U1	XXS	61	47
U2	XS	64	51
U3	S	66	53
U4	M	69	57
U5	L	71	60
U6	XL	73	62

Lower



2807S-L1



2807S-L2



2807S-L3



2807S-L4



2807S-L5



2807S-L6

Upper



2807S-U1



2807S-U2



2807S-U3



2807S-U4



2807S-U5



2807S-U6

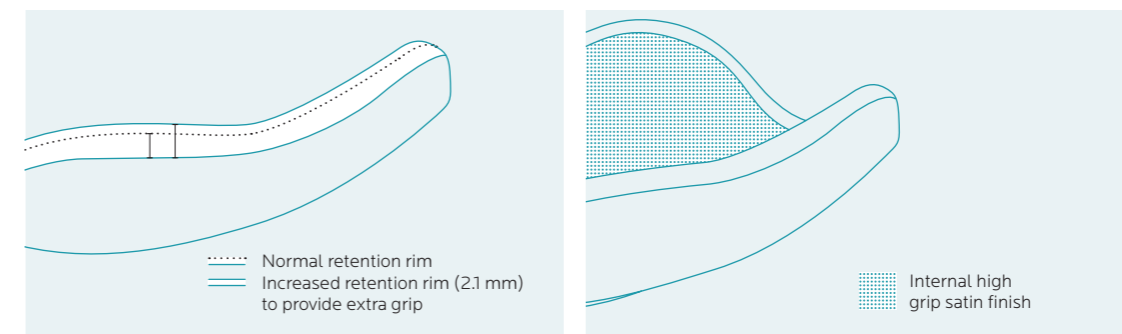

NON-PERFORATED STAINLESS STEEL IMPRESSION TRAYS - ANTERIOR DEPRESSED

with retention rim



2810 Lower

		A (mm)	B (mm)
L22	S	76	54
L21	M	79	57
L20	L	81	60

2810 Upper

		A (mm)	B (mm)
U7	S	70	57
U4	M	71	64
U1	L	81	67

NON-PERFORATED STAINLESS STEEL IMPRESSION TRAYS - EDENTULOUS

with retention rim



2808 Lower

		A (mm)	B (mm)
L69	S	70	57
L68	M	73	60
L67	NL	70	64
L66	L	86	64

NL: Narrow Large (large stretta)

2808 Upper

		A (mm)	B (mm)
U64	S	73	60
U63	NM	70	64
U62	M	76	67
U61	L	79	70

NM: Narrow Medium (medium stretta)

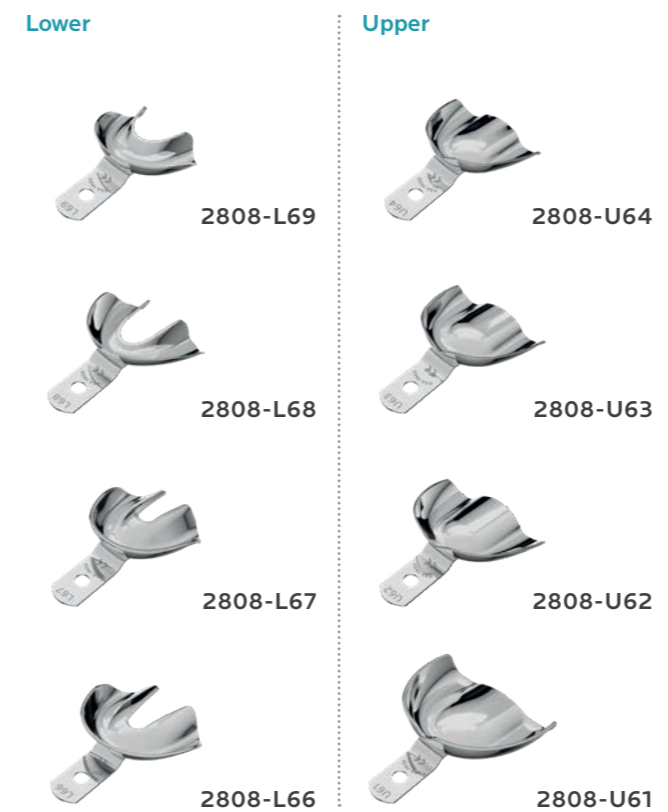
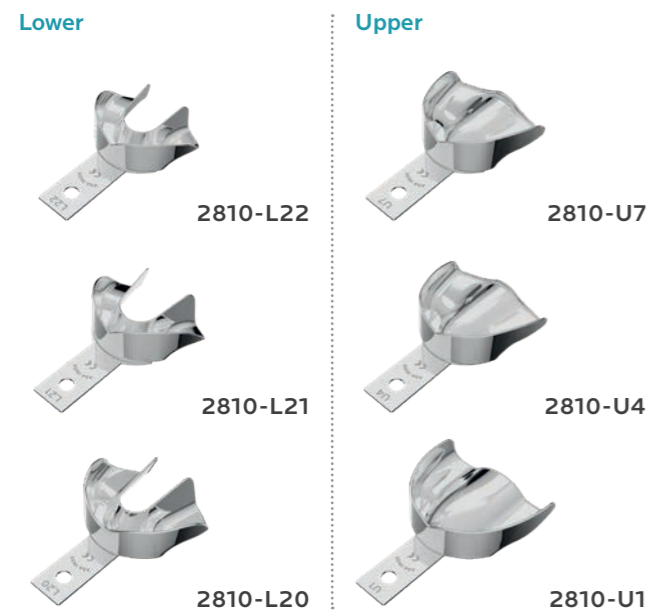

NON-PERFORATED STAINLESS STEEL IMPRESSION TRAYS - NEW SUPER HIGH GRIP

with increased retention rim and internal high grip satin finish

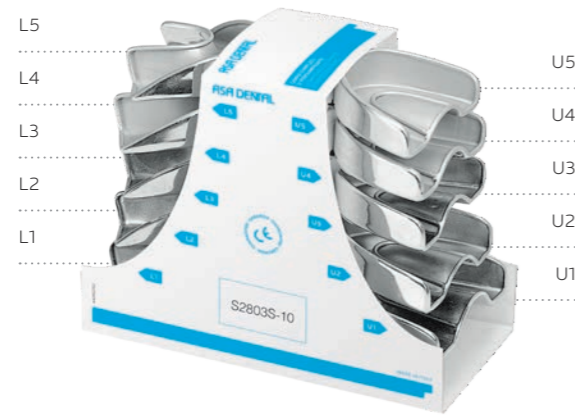

S2803S-10
set of 10

NON-PERFORATED STAINLESS STEEL IMPRESSION TRAYS - NEW SUPER HIGH GRIP

with increased retention rim and internal high grip satin finish

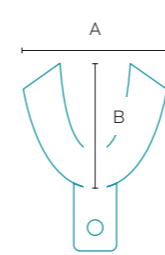

2803S Lower

		A (mm)	B (mm)
L5	XS	69	50
L4	S	72	57
L3	M	76	57
L2	L	78	59
L1	XL	80	63

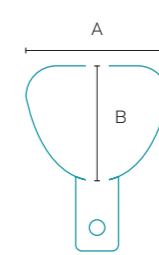

2803S Upper

		A (mm)	B (mm)
U5	XS	65	51
U4	S	67	53
U3	M	71	55
U2	L	74	60
U1	XL	81	63

Lower



2803S-L5



2803S-L4



2803S-L3



2803S-L2



2803S-L1

Upper



2803S-U5



2803S-U4



2803S-U3



2803S-U2



2803S-U1

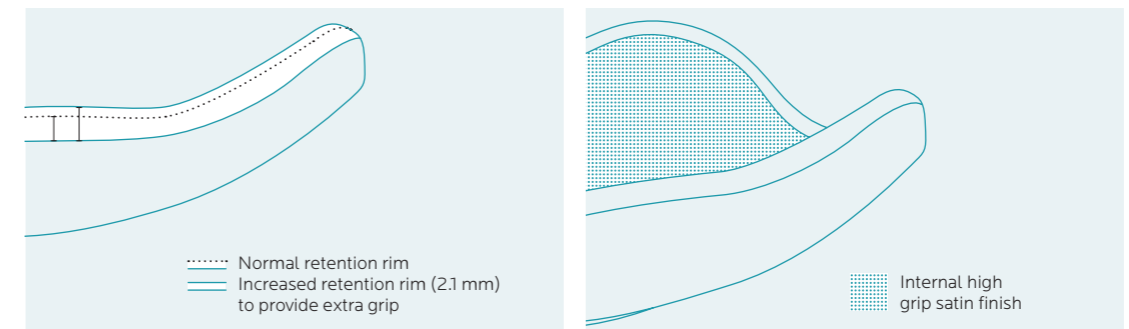







NON-PERFORATED STAINLESS STEEL IMPRESSION TRAYS

without retention rim



ASA Codicolor

-  U1/L1
XXS
-  U2/L2
XS
-  U3/L3
S
-  U4/L4
M
-  U5/L5
L
-  U6/L6
XL



S2802-12
set of 12



S2802-8
set of 8



S2802-6
set of 6

NON-PERFORATED STAINLESS STEEL IMPRESSION TRAYS

without retention rim

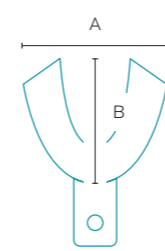

2802 Lower

		A (mm)	B (mm)
L1	XXS	55	47
L2	XS	60	49
L3	S	72	54
L4	M	74	57
L5	L	76	59
L6	XL	78	61

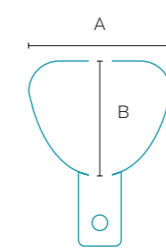

2802 Upper

		A (mm)	B (mm)
U1	XXS	61	47
U2	XS	64	51
U3	S	66	53
U4	M	69	57
U5	L	71	60
U6	XL	73	62

Lower



2802-L1



2802-L2



2802-L3



2802-L4



2802-L5



2802-L6

Upper



2802-U1



2802-U2



2802-U3



2802-U4



2802-U5



2802-U6

Partial



2802-L2D



2802-L4D



2802-L6D

Partial



2802-L2S



2802-L4S

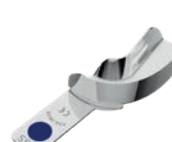







2802-L6S

NON-PERFORATED STAINLESS STEEL IMPRESSION TRAYS - ANATOMIC

without retention rim



ASA Codicolor

-  U1/L1
XXS
-  U2/L2
XS
-  U3/L3
S
-  U4/L4
M
-  U5/L5
L
-  U6/L6
XL



S2802A-12
set of 12



S2802A-8
set of 8



S2802A-6
set of 6

NON-PERFORATED STAINLESS STEEL IMPRESSION TRAYS - ANATOMIC

without retention rim

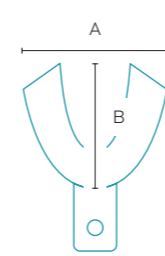

2802 Lower

		A (mm)	B (mm)
L1	XXS	55	47
L2	XS	60	49
L3	S	72	54
L4	M	74	57
L5	L	76	59
L6	XL	78	61

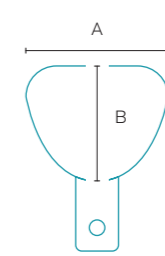

2802 Upper

		A (mm)	B (mm)
U1A	XXS	61	47
U2A	XS	64	51
U3A	S	66	53
U4A	M	69	57
U5A	L	71	60
U6A	XL	73	62

Lower



2802-L1



2802-L2



2802-L3



2802-L4



2802-L5



2802-L6

Upper



2802-U1A



2802-U2A



2802-U3A



2802-U4A



2802-U5A



2802-U6A

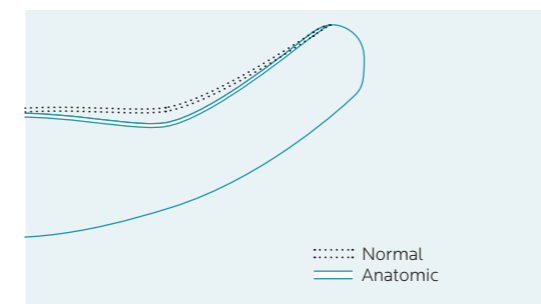

PERFORATED ALUMINUM IMPRESSION TRAYS

without retention rim



S2800-12
set of 12

PERFORATED ALUMINUM IMPRESSION TRAYS

without retention rim

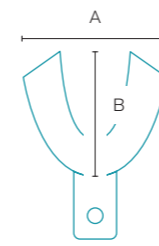

2800 Lower

		A (mm)	B (mm)
L1	XXS	56	48
L2	XS	59	50
L3	S	72	52
L4	M	76	57
L5	L	77	56
L6	XL	78	59

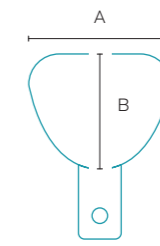

2800 Upper

		A (mm)	B (mm)
U1	XXS	63	48
U2	XS	66	51
U3	S	68	54
U4	M	71	58
U5	L	74	62
U6	XL	76	63

Lower



2800-L1



2800-L2



2800-L3



2800-L4



2800-L5



2800-L6

Upper



2800-U1



2800-U2



2800-U3



2800-U4



2800-U5



2800-U6

Partial



2800-L2D



2800-L4D



2800-L6D

Partial



2800-L2S



2800-L4S



2800-L6S

PERFORATED ALUMINUM IMPRESSION TRAYS FOR IMPLANTOLOGY
without retention rim



S2880-12
set of 12
S2880-12FR
set of 12 plus bur



2880-FR
bur in tungsten carbide with thin spiral cut
for aluminum alloys

PERFORATED ALUMINUM IMPRESSION TRAYS FOR IMPLANTOLOGY
without retention rim

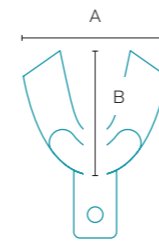

2880 Lower

		A (mm)	B (mm)
L1	XXS	56	48
L2	XS	59	50
L3	S	72	52
L4	M	76	57
L5	L	77	56
L6	XL	78	59

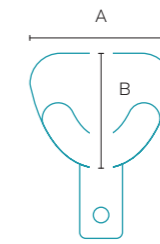

2880 Upper

		A (mm)	B (mm)
U1	XXS	63	48
U2	XS	66	51
U3	S	68	54
U4	M	71	58
U5	L	74	62
U6	XL	76	63

Lower



Upper



PERFORATED ALUMINUM IMPRESSION TRAYS - ORTHOBABY FOR CHILDREN
without retention rim

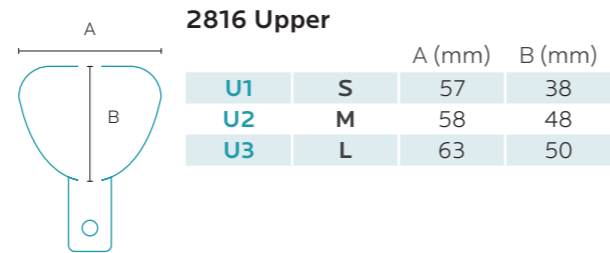
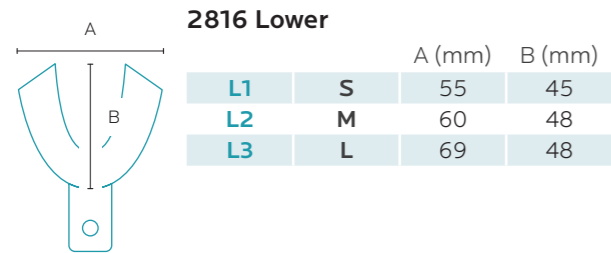

Lower

Upper



2816-L1



2816-U1



2816-L2



2816-U2



2816-L3



2816-U3



S2816-6
set of 6



PARTIAL OCCLUSAL STAINLESS STEEL IMPRESSION TRAYS

they allow you to take an impression of two opposing semi-arches



2819-OCG



2819-OCP

ASACLEAN

PH neutral solution to facilitate removal of alginate impression material from impression trays and instruments



8020
content 1000 ml

PERFORATED COLOR-CODED ALUMINUM IMPRESSION TRAYS FOR IMPLANTOLOGY

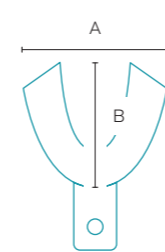

2814 Lower

		A (mm)	B (mm)
L0	XS	69	50
L1	S	72	57
L2	M	76	57
L3	L	78	59
L4	XL	80	63

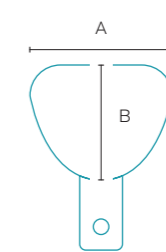

2814 Upper

		A (mm)	B (mm)
U0	XS	65	51
U1	S	67	53
U2	M	71	55
U3	L	74	60
U4	XL	81	63

Lower



2814-L0



2814-L1



2814-L2



2814-L3



2814-L4

Upper



2814-U0



2814-U1



2814-U2



2814-U3



2814-U4

POLYCARBONATE IMPRESSION TRAYS

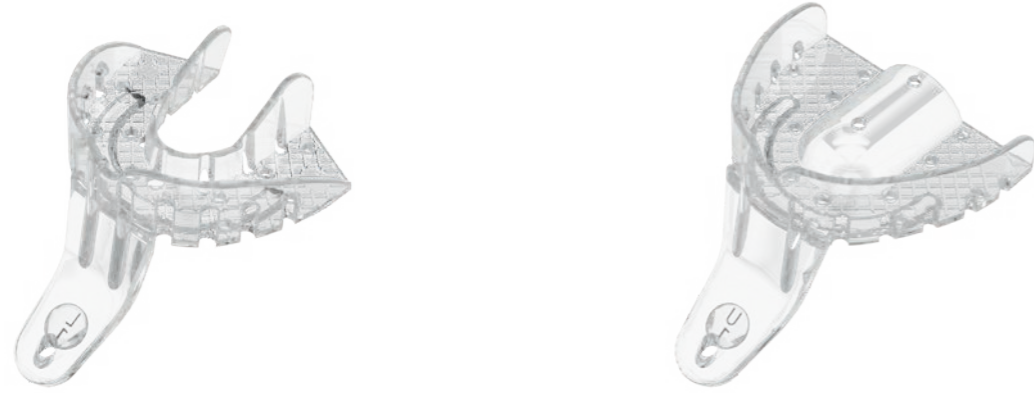

2852-12
set of 12

Lower		A (mm)	B (mm)
L1	61	50	
L2	67	52	
L3	72	56	
L4	74	58	

Upper		A (mm)	B (mm)
U1	61	49	
U2	65	53	
U3	70	59	
U4	73	6	

ORTHODONTIC POLYCARBONATE IMPRESSION TRAYS - FOR CHILDREN



2850-8
set of 8

Lower		A (mm)	B (mm)
L1	52	44	
L2	58	49	
L3	62	53	
L4	66	56	

Upper		A (mm)	B (mm)
U1	50	46	
U2	56	51	
U3	59	55	
U4	63	59	

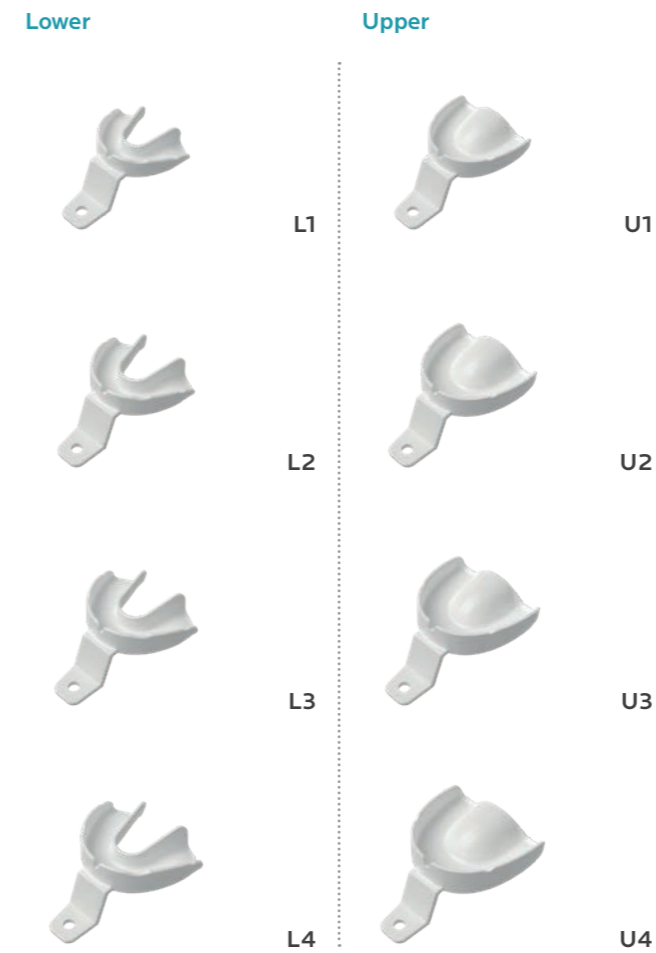
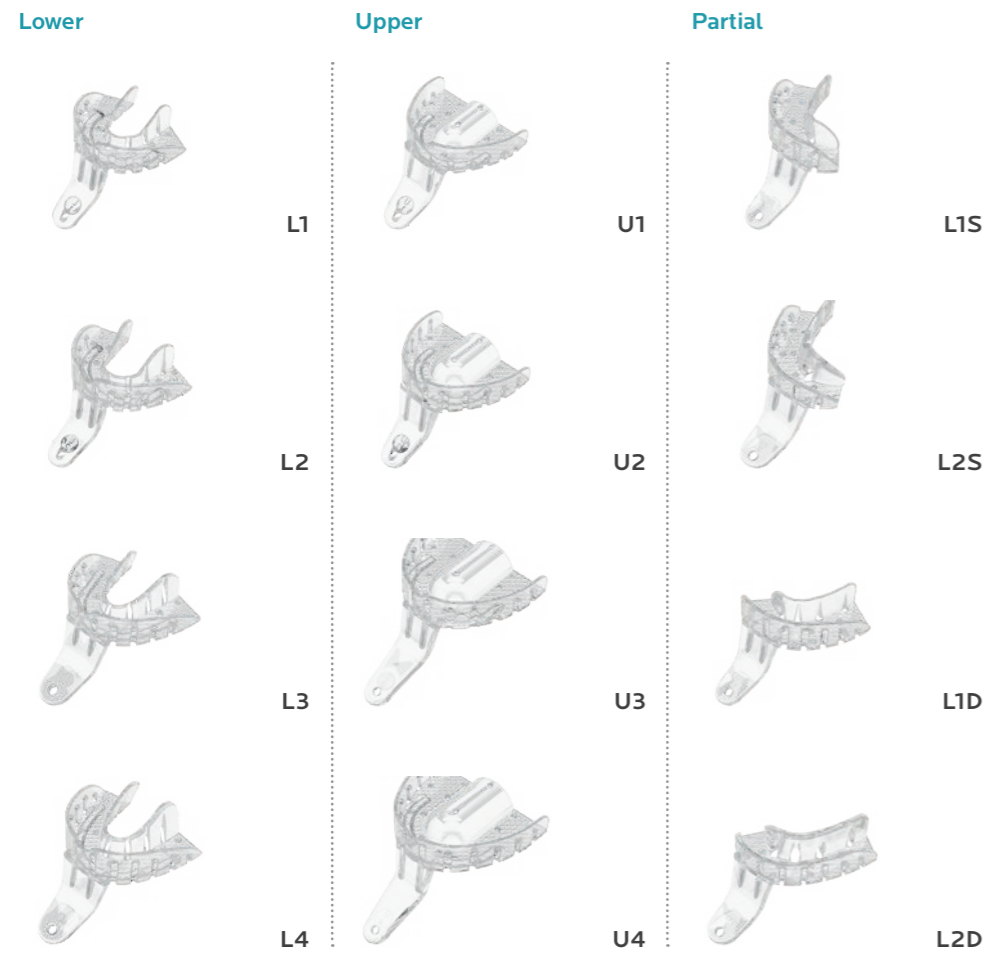

POLYCARBONATE IMPRESSION TRAYS - EDENTULOUS

autoclavable max. 130°C



S2851-24

Set of 24
13x lower
7x upper
4x mixed
compass

2851-13

Set of 13
lower

2851-7

Set of 7
upper

POLYCARBONATE IMPRESSION TRAYS - EDENTULOUS

autoclavable max. 130°C

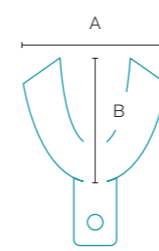

Lower

	A (mm)	B (mm)
L1	57	49
L2	58	53
L3	60	54
L4	61	55
L5	61	56
L6	61	57
L7	62	57
L8	64	55
L9	64	59
L10	66	57
L11	65	60
L12	67	56
L13	70	59

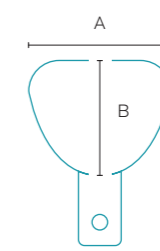

Upper

	A (mm)	B (mm)
U1	62	53
U2	64	57
U3	61	58
U4	66	60
U5	70	62
U6	74	63
U7	75	64

Mixed

	A (mm)	B (mm)
U1P	64	54
U2P	67	58
L1C	75	49
L2C	75	54

Lower

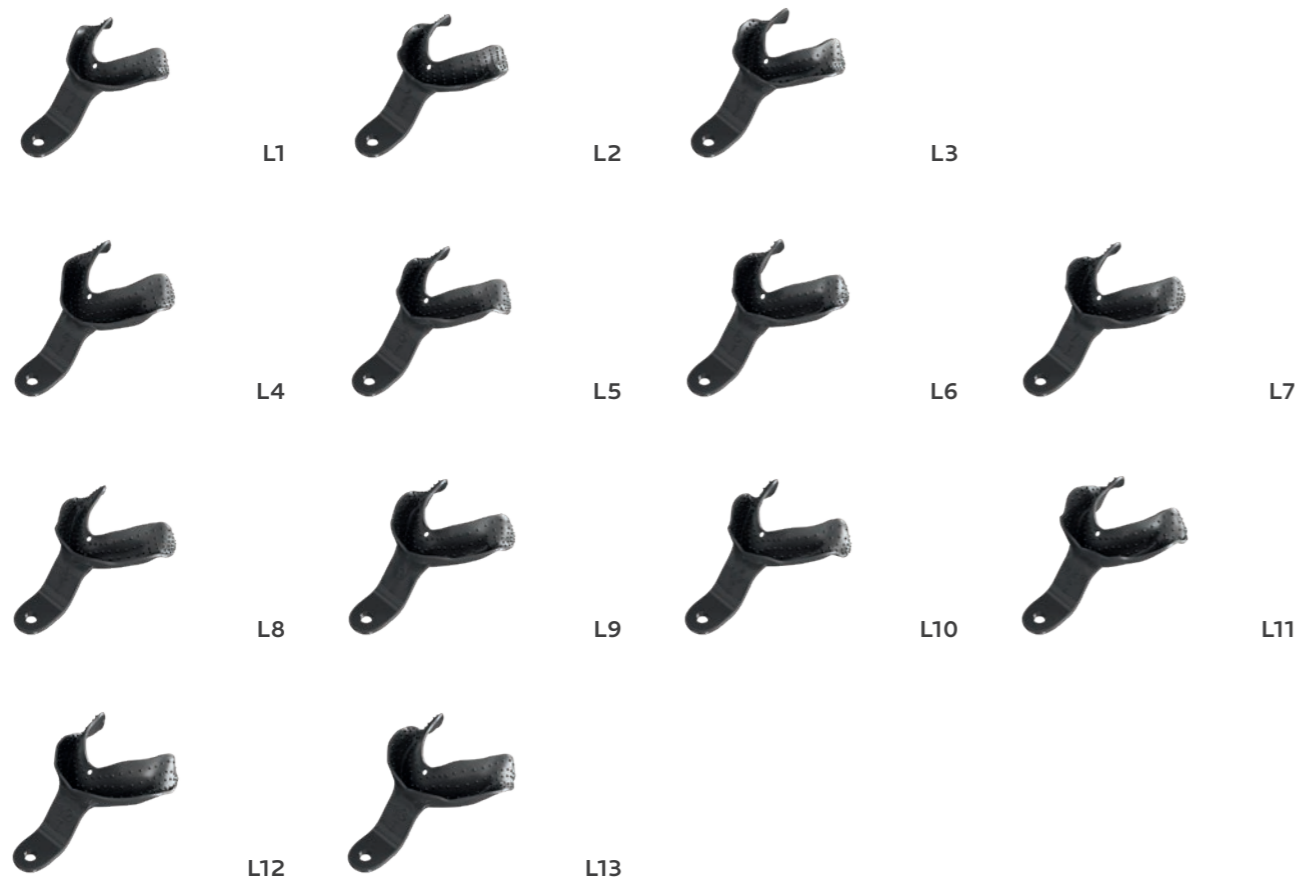

Upper

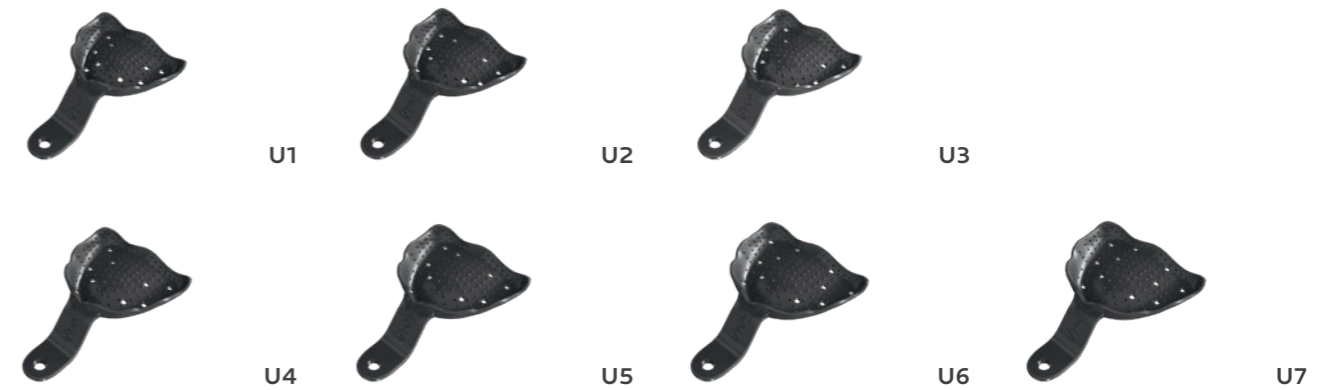

Mixed



LABORATORY INSTRUMENTS

MADE IN ITALY



L2	Articulators
L10	Easy Bow
L13	Wax carvers
L18	Waxing instruments
L19	Tweezers
L20	Brushes for ceramics
L21	Instruments for ceramics
L22	Knives
L24	Spatulas and bowls
L27	Prosthesis boxes
L28	Scissors
L29	Crown instruments
L30	Calipers
L31	Mallets
L32	Crucible tongs
L33	Saws and Blades
L34	Kits

THE WINNING FORMULA: ADVANCED SKILLS AND TECHNIQUES

For unexpected results in which impressions are transformed into successful dental prostheses, the behind-the-scenes work of a qualified dental technician is fundamental. Based on detailed prescriptions that include anatomical and functional information, the job of any technician is a mix of technical expertise, artistic skills, state-of-the-art materials and precise instruments to carefully create crowns, bridges, partial prostheses, and removable and full dentures.

Asa Dental Laboratory instruments range from highly versatile articulators to a wide range of accessories and precise modelling instruments; all necessary to shape materials and help dentists restore the function and aesthetics of a patient's mouth.



ARTICULATORS

Average values

5050 and 5050PLUS are non-Arcon average value articulators designed to simplify and speed up work on any plaster and meet professional demands for high precision regardless of the prosthetic technique. Their light, stable and ergonomic construction facilitates set-up and work on any cast, starting from the upper arch or the lower one, with the option to work comfortably, inclining the articulator 60 degrees. These articulators make it possible to perfectly simulate the condylar path to ensure the precision that gives prostheses and dental restorations optimal functionality and occlusion, whatever the patient's mandibular movement.

The 5050 articulator can efficiently work with prostheses of many different sizes and any electronic pressure polymerizers available on the market. Designed for optimal ergonomics, it offers complete stability when the technician comfortably works at 60° or upside down, in case of class III edentulous patients.

The anti-rotational system for the incisal guide rod ensures that positioning is always correct and accurate, while the bearing rod ensures stability when the upper part is completely open. The occlusal table and the mounting jigs have 4 elliptical reference lines to help properly position the plaster regardless of size, whether starting from the upper or lower arch.

FEATURES

- Stable 60° operation for ergonomic comfort
- Ideal for class III patients
- Compatible with all commercially available pressure polymerizers
- Anti-rotation system for the incisal guide rod
- Mounting jig with 4 elliptic guides for lower arch models
- Occlusal table with 4 elliptic guides for upper arch models
- Bearing rod for stability when fully open
- Anti-shock protection system

Technical data

Intercondylar distance	110 mm
Condylar inclination fixed at	30°
Bennett angle	0 - 7°
Incisal table inclination	10°
Distance between mounting plates	87 mm
Opening	180°

Equipment:

4 mounting plates	5000-1
2 locking knobs	5011-6



5050

ARTICULATORS

Average values

The 5050PLUS is the most versatile articulator of those that compose the line of Asa Dental laboratory instruments. Offering all the standard features of 5050, the 5050PLUS has the added benefit of being the only rear-rod system with an inclined plate which guarantees absolute precision even when the incisal guide rod is removed to increase visibility. The rear adjustment screws ensure the guides and inclinations remain unchanged during all combinations of lateral movements, protrusion and retrusion.

The configuration is completed by a magnetic incisal guide rod system that prevents alteration of the model while the plaster is drying. Simple, accurate and ergonomic, 5050PLUS is the most effective Asa Dental solution for dental technicians looking for a flexible and reliable average value, non-Arcon articulator.

FEATURES

- Stable 60° operation for ergonomic comfort
- Ideal for class III patients
- Compatible with all commercially available pressure polymerizers
- Anti-rotation system for the incisal guide rod
- Total stability and precision when working without the incisal guide rod thanks to an adjustable rear rod
- Mounting jig with 4 elliptic guides for lower arch models
- Occlusal table with 4 elliptic guides for upper arch models
- Magnetic incisal guide rod for total stability as the plaster dries
- Bearing rod for stability when fully open
- Anti-shock protection system

Technical data

Intercondylar distance	110 mm
Condylar inclination fixed at	30°
Bennett angle	0 - 7°
Incisal table inclination	0°
Distance between mounting plates	87 mm
Inclined contrast table	24°
Opening	180°

Equipment:

4 mounting plates	5000-1
2 locking knobs	5011-6



5050PLUS

ARTICULATORS

Average values

Lightweight anatomic articulator made of die-cast aluminum alloy. It can be used with the Camper table or with the arbitrary face bow; fixing according to centric:

- Automatic return to the hinge axis with springs
- Perfect stability in open position
- Anti-shock hinge rod which stops it from breaking or being damaged if the articulator falls accidentally
- Bigger size lock screws for mounting plates
- Anatomic rear abutment ensures the stability and practicality of the articulator

FEATURES

- Increased height and width
- More space when using removable stump systems
- More space for installation of mobile prostheses with high chewing or big base
- More space when using magnetic plates
- Better back access
- Variable internal working distance
- Incisal guide rod and bearing rod for 180° opening are in stainless steel
- Stainless steel hinge rod
- Anti-shock protection system

Technical data

Intercondylar distance	120 mm
Condylar inclination fixed at	30°
Bennett angle fixed at	7°
Incisal table inclination	10°
Distance between mounting plates	90-110 mm
Weight	700 gr
Opening	180°

Equipment:

2 spacers	5030-29
4 mounting plates	5000-1
2 locking knobs for spacers	5030-6
2 locking knobs for plates	5011-6

Accessories

Face bow	5021
Transfer table	5024
Occlusal table	5030-2
Fast caliper	5033



5030



ARTICULATORS

Average values

The 5032 has the same features as mod. 5030, plus:

- Back rod adjusted by a micrometer adjustment screw to work without the incisal guide rod and to keep the trajectories and inclinations unaltered during side and back/forward movements
- Pure translation movement (key and instructions included)

FEATURES

Back rod on top for unaltered rear access and visibility; hinge axis with pure translation movement allowed.

Technical data

Intercondylar distance	120 mm
Condylar inclination fixed at	30°
Bennett angle fixed at	7°
Incisal table inclination	10°
Distance between mounting plates	90-110 mm
Weight	700 gr
Opening	180°

Equipment:

2 spacers	5030-29
2 magnetic mounting plates	5000-1M
2 locking knobs for spacers	5030-6
2 locking knobs for plates	5011-6

Accessories

Face bow	5021
Transfer table	5024
Occlusal table	5030-2
Fast caliper	5033



5032



ARTICULATORS

Average values

Equipment:

2 mounting plates	5000-1
2 locking knobs for plates	5050-6



5002

OCCLUSOR



5001

ARTICULATORS

Spare parts

- Mounting plate
- Die-cast aluminum mounting plate
- Applicable to articulators:
5050
5050PLUS
5030
5032
5002
5000
5010
5011

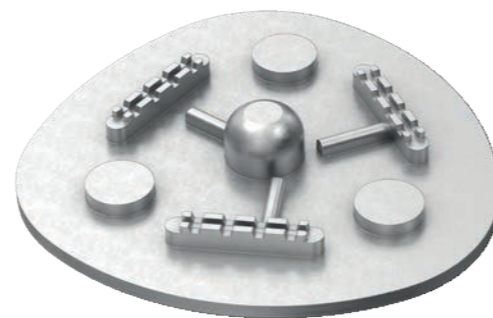

5000-1

ARTICULATORS

Spare parts

- 5000-26**
Magnet



5000-26



- 5000-30**
Magnet holder



5000-30

5000-1M

- Die-cast aluminum Teflon covered mounting plate
- Magnet holder (5000-30)
- Magnet (5000-26)
- Applicable to articulators:
5050
5050PLUS
5030
5032
5002
5000
5010
5011



5000-1M



5000-30



5000-26

5000-25

- Counter-magnet for plaster for Teflon-coated aluminum die-cast plate
- 10 pcs / pack



5000-25

5030-29

- Spacer
- Applicable to articulators:
5030
5032



5030-29

ARTICULATORS

Spare parts

5050PLUS



5050

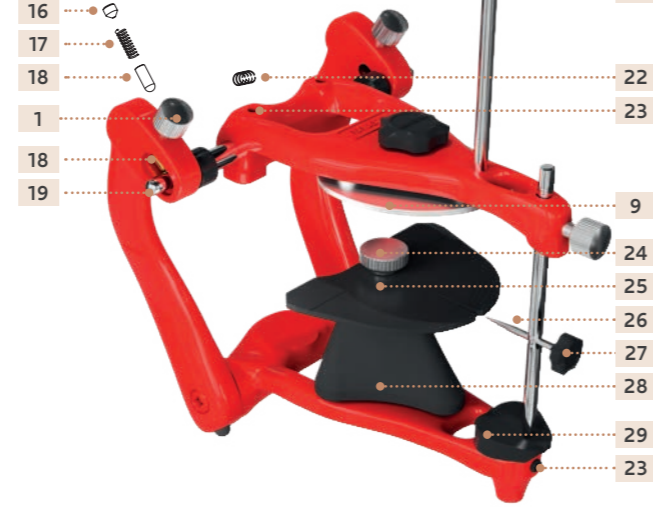

5030/5032

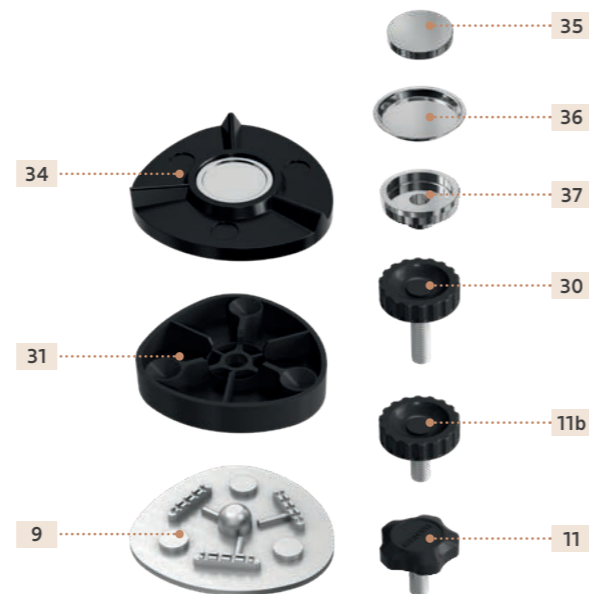
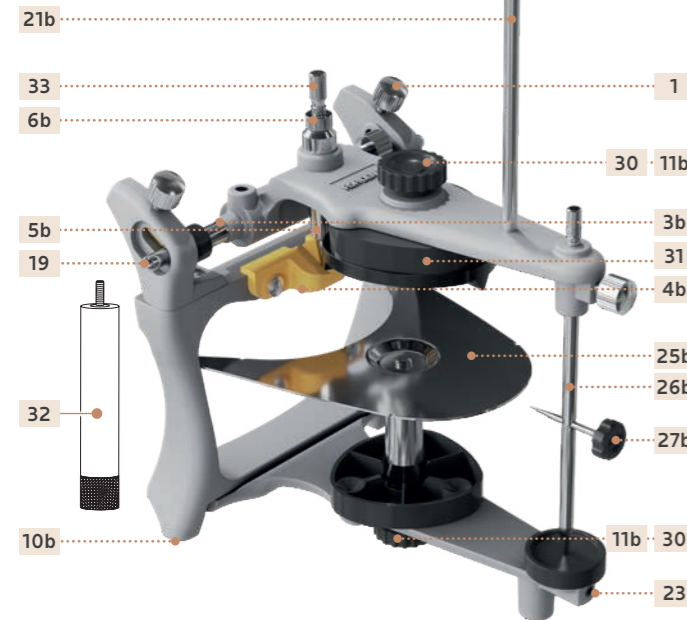

ARTICULATORS

Spare parts

		5050PLUS	5050	5032	5030
1	Metallic locking knob	5000-5	5000-5	5000-5	5000-5
2	Hinge rod washer	5011-18	5011-18	5011-18	5011-18
3, 3b	Hinge rod	5050-17	5050-17	5032-17	5032-17
4, 4b	Inclined contrast table	5011-16		5032-16	
5, 5b	Back rod	5050-21		5032-21	
6, 6b	Adjusting screw locknut	5011-23		5032-23	
7	Back rod support	5050-20			
8	Mounting jig	5052	5052		
9	Mounting plate	5000-1	5000-1	5000-1	5000-1
10, 10b	Rubber nubs (6 pcs/pack)	5050-24	5050-24	5000-24	5000-24
11, 11b	Locking knob	5050-6	5050-6	5011-6	5011-6
12	Rod ferrule	5053-2			
13	Magnetic rod	5053-1			
14	Table for magnetic rod	5053-3			
12+13+14	Magnetic rod kit	5053			
15	Incisal table (0°)	5011-4		5011-4	
16	Adjusting screw - side shift	5000-7	5000-7	5000-7	5000-7
17	Side shift spring	5000-12	5000-12	5000-12	5000-12
18	Side shift cylinder	5000-13	5000-13	5000-13	5000-13
19	Condylar guidance rod	5030-9	5030-9	5030-9	5030-9
20	Rubber knob	5011-11	5011-11	5011-11	5011-11
21, 21b	Bearing rod	5010-10	5010-10	5030-10	5030-10
22	Hinge rod spring	5011-19	5011-19	5011-19	5011-19
23	M5 screws - incisal table	5000-18	5000-18	5000-18	5000-18
24	Knurled knob for mounting jig and occlusal table	5050-4	5050-4		
25, 25b	Occlusal table	5051	5051	5030-2	5030-2
26, 26b	Incisal guide rod	5050-3	5050-3	5030-3	5030-3
27, 27b	Incisal indicator pin	5050-8	5050-8	5000-8	5000-8
28	Support for occlusal table and mounting jig	5050-2	5050-2		
24+25+28	Occlusal table assembly (5050-4 + 5051 + 5050-2)	5054	5054		
29	Incisal table (10°)		5000-4N		5000-4N
30	Locking knob for spacer			5030-6	5030-6
31	Spacer			5030-29	5030-29
32	Fast caliper			5033	5033
33	Adjusting screw			5032-22	
34	Magnetic mounting plate - complete	5000-1M	5000-1M	5000-1M	5000-1M
35	Magnet	5000-26	5000-26	5000-26	5000-26
36	Cast fastening washers (10 Pcs/pack)	5000-25	5000-25	5000-25	5000-25
37	Magnet holder	5000-30	5000-30	5000-30	5000-30

EASY BOW

5020

complete set including facebow with three forks and transfer table for articulator

Face bow	5021
Fork holder block	5022
Transfer table	5024
Fork	5023-1
Fork	5023-2
Fork	5023-3

set compatible with articulators:

5030
5032



5021



5022



5024



5023-1



5023-2



5023-3

EASY BOW

instructions

1. Insert the fork holder block into the bow
2. Insert the fork into the patient's mouth
3. Pull the Condylar rods outwards and insert the facebow
4. Regulate the Nasion position referring to the Frankfurt plane
5. Connect the fork holder rod and lock all the knobs
6. Face bow positioned
7. Pull the Condylar rods outwards and extract the face bow
8. Loosen the knob and extract the fork holder block
9. Position the fork holder block in the transfer table...
10. ...and tighten the knob
11. If necessary, adjust the little plate height; then remove the fork holder block
12. Place the plaster on the plate and reposition the fork holder block
13. After the plaster has hardened, loosen the knob connected to the fork rod...
14. ...and extract the rod
15. Release the knob and extract the fork holder block
16. Place the table on the articulator...
17. ...inserting it into the special recesses
18. Affix the table to the articulator with the screw provided with the articulator
19. Place the model on the wax bite
20. Put the plaster on the model...
21. and complete the "articulator setup" as usual

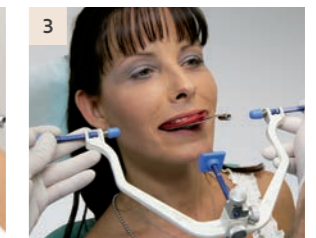
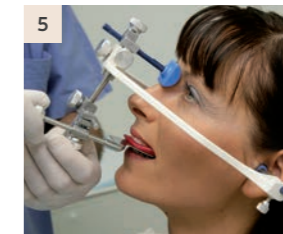
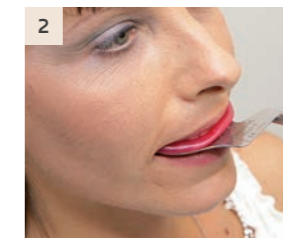
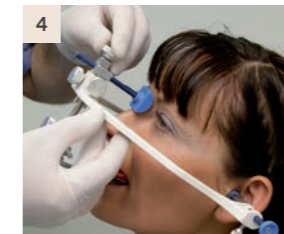

HANDLE OPTIONS

SINGLE-END

● Alu80
(aluminum, hollow)
ø 8,0 mm



DOUBLE-END

Asa60
(stainless steel)
ø 6,0 mm



Asa Light MV
(stainless steel, hollow)
ø 8,0 mm



● Alu80
(aluminum, hollow)
ø 8,0 mm



MODELING INSTRUMENTS

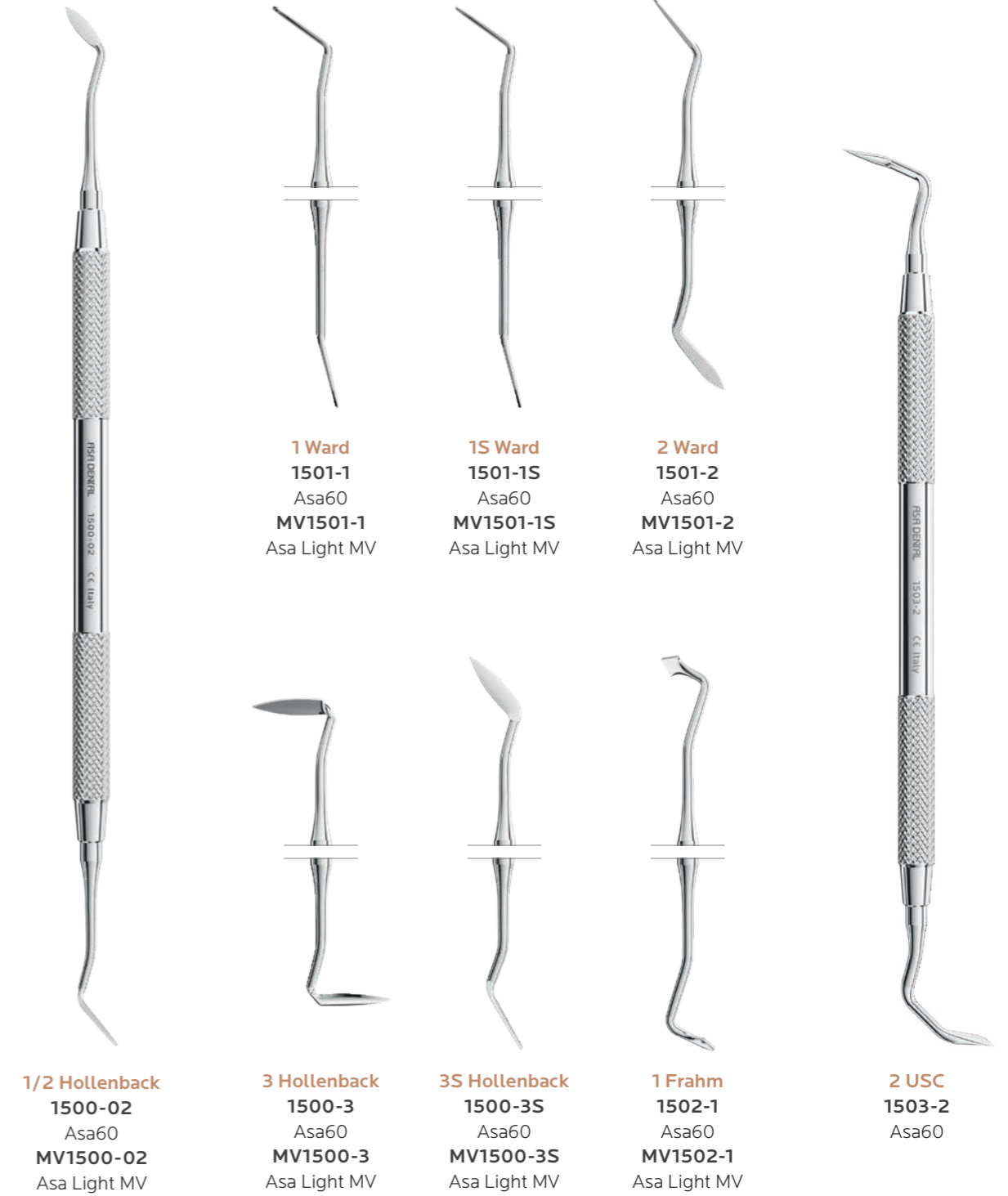

1 Ward
1501-1
Asa60
MV1501-1
Asa Light MV

1S Ward
1501-1S
Asa60
MV1501-1S
Asa Light MV

2 Ward
1501-2
Asa60
MV1501-2
Asa Light MV

1/2 Hollenback
1500-02
Asa60
MV1500-02
Asa Light MV

3 Hollenback
1500-3
Asa60
MV1500-3
Asa Light MV

3S Hollenback
1500-3S
Asa60
MV1500-3S
Asa Light MV

1 Frahm
1502-1
Asa60
MV1502-1
Asa Light MV

2 USC
1503-2
Asa60

MODELING INSTRUMENTS

MODELING INSTRUMENTS



Hylin
graded handle
in mm
5100-1



Hylin
5100

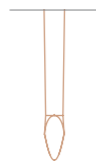

Hylin-Le Cron
5101



Hylin-Ceramica
5102



Hylin-ASA
5103

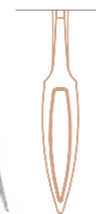

ASA
5104



Le Cron
5105



Le Cron
5106



Le Cron
5107



Le Cron
5108

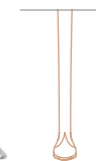

Zahle
5109



Zahle
5110

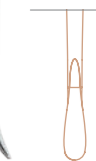

MODELING INSTRUMENTS

MODELING INSTRUMENTS

Sets of 5



Model	Set Code	Handle
1 · 2 · 3 · 4 · 5	S5112	Asa60
1AL · 2AL · 3AL · 4AL · 5AL	S5112AL	Alu80

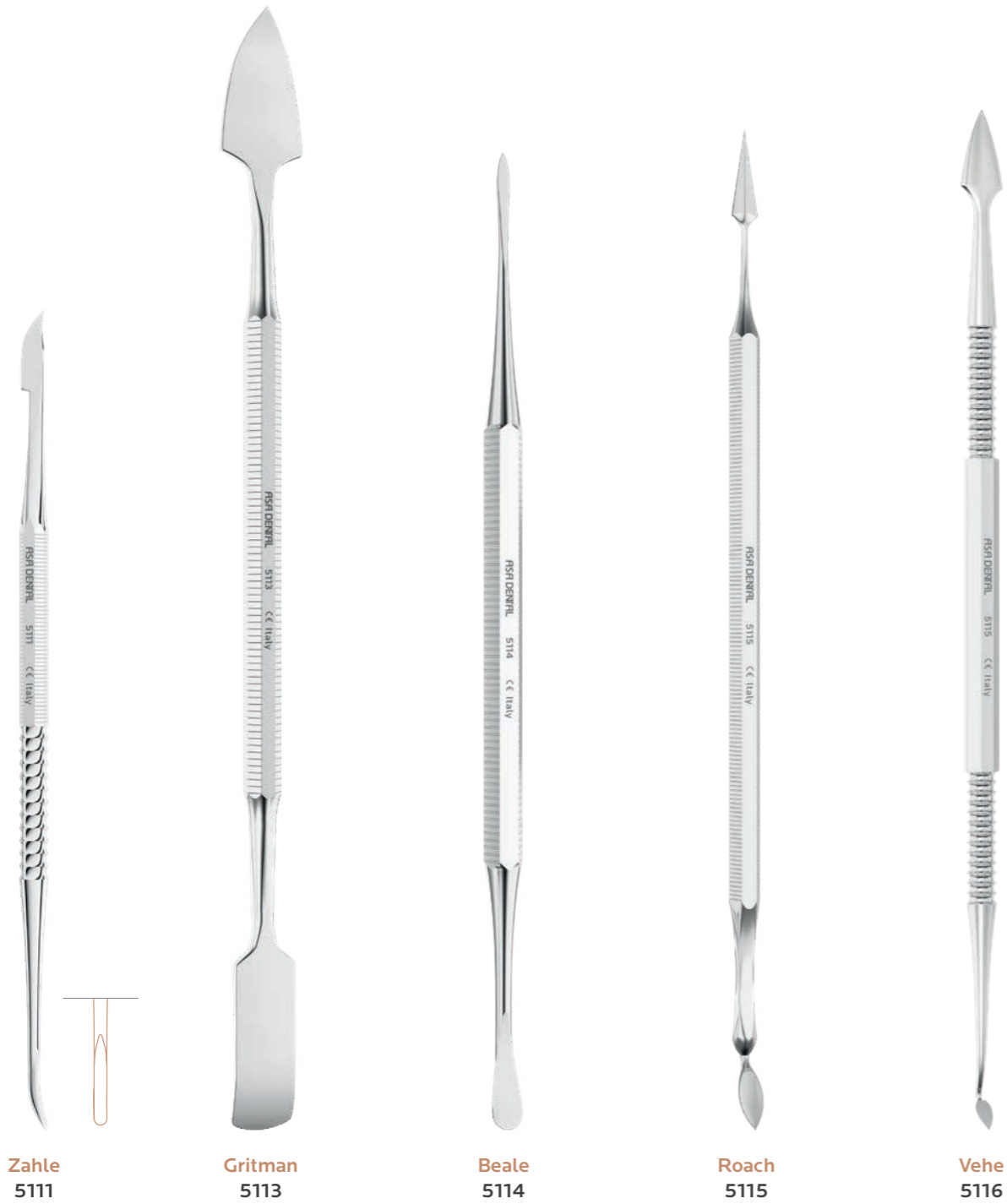

Zahle 5111
Gritman 5113
Beale 5114
Roach 5115
Vehe 5116

1 P. K. Thomas 5112-1 Asa60
4 P. K. Thomas 5112-4 Asa60
5 P. K. Thomas 5112-5 Asa60
1 P. K. Thomas 5112-1AL Alu80
4 P. K. Thomas 5112-4AL Alu80
5 P. K. Thomas 5112-5AL Alu80

WAXING INSTRUMENTS WITH REPLACEABLE TIPS

Set of 3+3



Model	Set Code
1 · 2 · 3 · 1C · 2C · 3C	S5160



1
S5160-1C
● Alu80



2
S5160-2C
● Alu80



3
S5160-3C
● Alu80



1
5160-1



2
5160-2



3
5160-3

LABORATORY TWEEZERS



1
16,5 cm
6400-1



2
16 cm
6400-2



3 Meriam
16 cm
0601-3



2
12 cm
0645-2



3
11,5 cm
0645-3



3
15 cm
0635-3



4
18 cm
0635-4



6
26 cm
0635-6

BRUSHES FOR CERAMICS



CERAMIC SCULPTING INSTRUMENTS

Sets of 3 handles + 6 tips

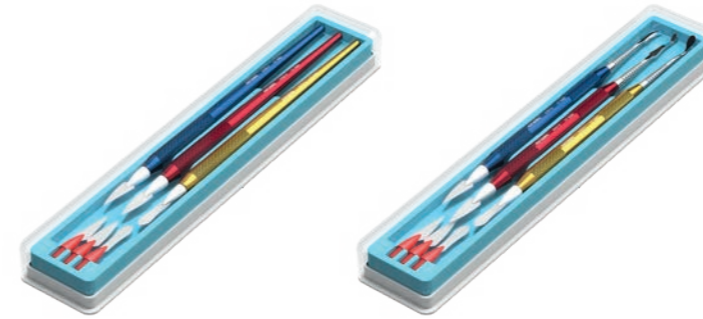

Model	Set Code
5150-1 · 5150-2 · 5150-3	5150
5156-1 · 5156-2 · 5156-3	

Model	Set Code
5151-1 · 5151-2 · 5151-3	5151
5156-1 · 5156-2 · 5156-3	



WAX KNIVES

PLASTER KNIVES



1 Fahnenstock
13 cm
5200-1

2 Fahnenstock
17 cm
5200-2

1 Lessmann
13 cm
5201-1

2 Lessmann
18 cm
5201-2

WITH SMALL SPOON
1
13 cm
5202-1

WITH SMALL SPOON
2
17 cm
5202-2



1
17 cm
5300-1

2
Gritman
17 cm
5300-2

3
15,5 cm
5300-3

4
16 cm
5300-4

The wooden handle may vary in color

The wooden handle may vary in color

RIGID SPATULAS FOR PLASTER, ALGINATE AND ELASTOMERS

Alginate, plaster

Alginate

Elastomers



The wooden handle may vary in color

FLEXIBLE SPATULAS FOR PLASTER, ALGINATE AND ELASTOMERS

Alginate, plaster

Alginate

Elastomers



The wooden handle may vary in color

SPATULAS FOR PLASTER AND ALGINATE



18,5 cm 5401-B 18,5 cm 5401-C 18,5 cm 5401-F 18,5 cm 5401-G 18,5 cm 5401-R 18,5 cm 5401-V

MIXING BOWLS FOR PLASTER AND ALGINATE



Ø 160 mm Ø 140 mm Ø 120 mm Ø 100 mm

2,2 L 5500-16 0,9 L 5500-14 0,5 L 5500-12 0,35 L 5500-10

Ø 160 mm Ø 140 mm Ø 120 mm Ø 100 mm

2,2 L 5501-16 0,9 L 5501-14 0,5 L 5501-12 0,35 L 5501-10

ORTHO/PROSTHESIS BOXES

Plastic box for removable retainers
10 pcs / pack



Blue 6900E-A

White 6900E-B

Light blue 6900E-C

Yellow 6900E-G

Pink 6900E-R

Green 6900E-V

SCISSORS
for gold foils



1
straight
12 cm
0300-1

2
curved
12 cm
0300-2

WIRE SCISSOR
one serrated blade



Universal
12 cm
5700

CROWN SCISSORS



1
straight
one serrated blade
10,5 cm
5600-1

2
curved
one serrated blade
10,5 cm
5600-2

1
straight
10,5 cm
5601-1

2
curved
10,5 cm
5601-2

CROWN INSTRUMENTS



13 cm
0545-1

Telescope crown pliers

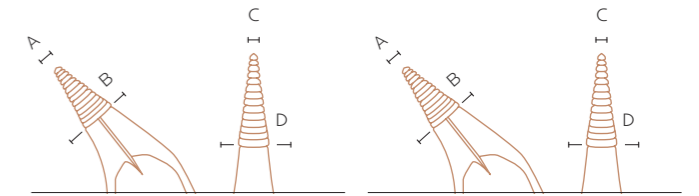

A	4,4 mm	A	3,3 mm
B	5,0 mm	B	4,0 mm
C	3,4 mm	C	2,3 mm
D	3,8 mm	D	3,0 mm



Böhm
14,5 cm
2500-2



Böhm
11,5 cm
2500-1

CROWN INSTRUMENTS

*indicative measures

Spring calipers

measuring range: 0-10 mm*



Iwanson
for wax
2550-1

measuring range: 0-10 mm*



Iwanson
for metal
2550-2

measuring range: 0-15 mm*



16 cm
2557-1

Decimal calipers

measuring range:
0-200 mm / 0-7 in*



aluminum
graded in mm and in
2556-1

measuring range:
0-100 mm / 0-4 in*



Townley
graded in mm and in
2556-2

measuring range:
0-100 mm / 0-4 in*



Jameson
graded in mm and in
2556-3

measuring range:
0-100 mm*



Boley
14 cm
2555

PLASTER CUTTING PLIERS



Asa Special
Stainless Steel
19,5 cm
5900

MALLETS

Riveting mallets



22 cm
6000



22 cm
6001

Horn mallet



20 cm
6002

CRUCIBLE TONGS

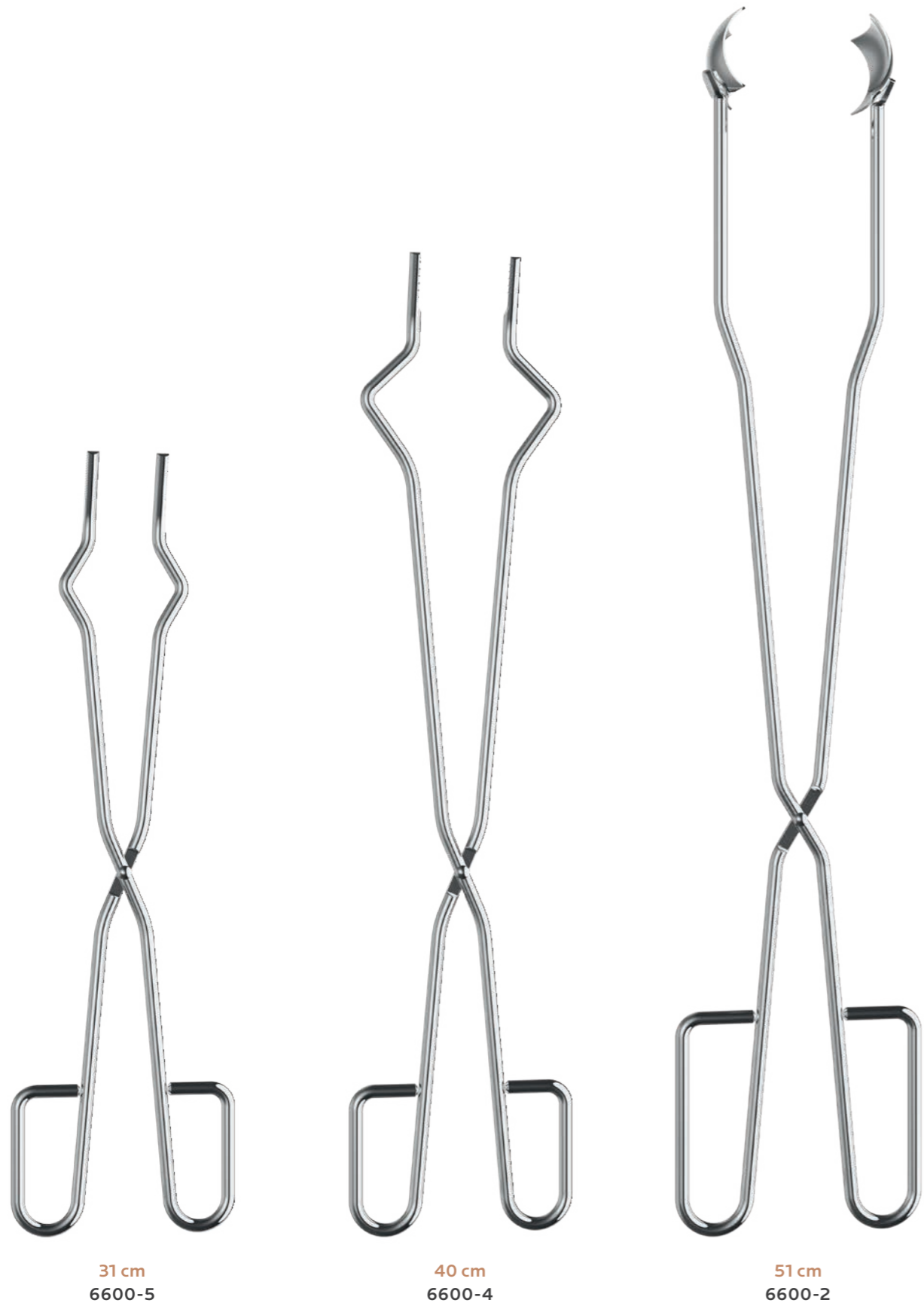

31 cm
6600-5

40 cm
6600-4

51 cm
6600-2

SAWS AND BLADES

Fret saw

*Length x Height x Thickness



25 cm
6200

Fret saw blades

12 pcs / pack



130 mm x Ø 1,3 mm*
for plaster
6201-1

130 x 0,52 x 0,26 mm*
for metal
6201-2

Saw for models

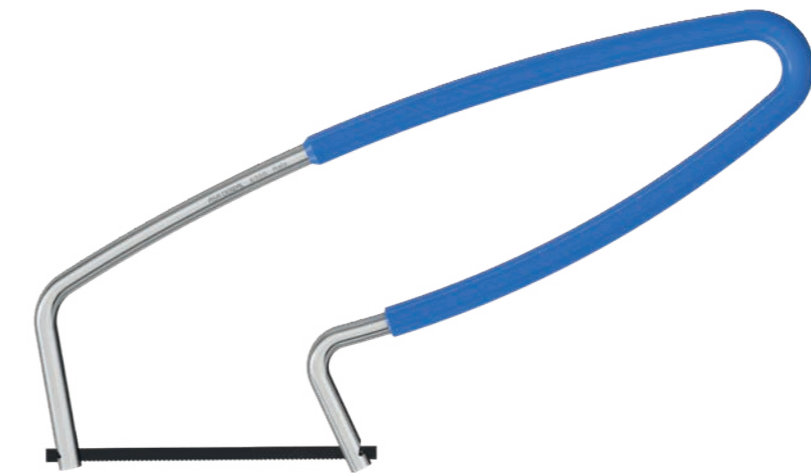

18 cm
6300

Fret saw blades

12 pcs / pack

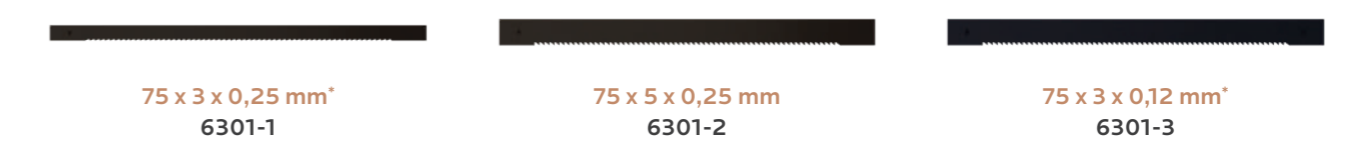

75 x 3 x 0,25 mm*
6301-1

75 x 5 x 0,25 mm
6301-2

75 x 3 x 0,12 mm*
6301-3

ORTHODONTIC LAB SET

Case with wax and porcelain modelling instruments



S6811-2

5100	Hylin modelling carver	
5101	Hylin-Le Cron modelling carver	
5105	Hylin modelling carver	
5111	Zahle modelling carver	
5112-1	P. K. Thomas modelling carver	1
5112-2	P. K. Thomas modelling carver	2
5112-3	P. K. Thomas modelling carver	3
5112-4	P. K. Thomas modelling carver	4
5112-5	P. K. Thomas modelling carver	5
5113	Gritman modelling carver	
S5160-1C	wax sculpting instrument	1
S5160-2C	wax sculpting instrument	2
S5160-3C	wax sculpting instrument	3
5200-1	Fahnenstock wax knife	1
5200-2	Fahnenstock wax knife	2
2555	caliper	

Empty case for 17 instruments



8000

ORTHODONTIC LAB SET

Laboratory sets with plastic case



S6810-1

6400-2	laboratory tweezers	2
5900	plaster cutting pliers	
6300	saw for models	
5500-12	mixing bowl - ø 120 mm	
5600-2	crown scissors	2
5400-6	spatula for plaster and alginate	6
5300-2	Gritman plaster knife	2
5200-1	Fahnenstock wax knife	1
5200-2	Fahnenstock wax knife	2
5801-1	wire forming pliers	
2550-2	Iwanson caliper	
6001	mallet	
5100	Hylin modelling carver	
5101	Hylin-Le Cron modelling carver	
5102	Hylin-Ceramica modelling carver	
5105	Hylin modelling carver	
5106	Le Cron modelling carver	
5109	Zahle modelling carver	
5113	Gritman modelling carver	
5114	Beale modelling carver	
5112-1	P. K. Thomas modelling carver	1
5112-2	P. K. Thomas modelling carver	2
5112-3	P. K. Thomas modelling carver	3
5112-4	P. K. Thomas modelling carver	4
5112-5	P. K. Thomas modelling carver	5



S6810-2

6400-2	laboratory tweezers	2
5900	plaster cutting pliers	
6300	saw for models	
5500-12	mixing bowl - ø 120 mm	
5600-2	crown scissors	2
5400-6	spatula for plaster and alginate	6
5300-2	Gritman plaster knife	2
5200-1	Fahnenstock wax knife	1
5200-2	Fahnenstock wax knife	2
2550-2	Iwanson caliper	
5150	Ceramic sculpting instruments set	
5101	Hylin-Le Cron modelling carver	
5106	Le Cron modelling carver	
5109	Zahle modelling carver	
5113	Gritman modelling carver	
5114	Beale modelling carver	
5112-1	P. K. Thomas modelling carver	1
5112-2	P. K. Thomas modelling carver	2
5112-3	P. K. Thomas modelling carver	3
5112-4	P. K. Thomas modelling carver	4
5112-5	P. K. Thomas modelling carver	5



the modelling tool kit (S5112) is included in the cases S6810-1 and S6810-2, placed in a white cardboard package as shown here

CODE INDEX

CODE	DESCRIPTION	HANDLE	PAGE
0100-1	Extracting forceps		D4
0100-2	Extracting forceps		D4
0100-3	Extracting forceps		D4
0100-4	Extracting forceps		D4
0100-7	Extracting forceps		D4
0100-8	Extracting forceps		D4
0100-13	Extracting forceps		D5
0100-17	Extracting forceps		D5
0100-18	Extracting forceps		D5
0100-18A	Extracting forceps		D5
0100-19	Extracting forceps		D6
0100-20	Extracting forceps		D5
0100-21	Extracting forceps		D5
0100-22	Extracting forceps		D6
0100-22L	Extracting forceps · Routurier		D6
0100-22R	Extracting forceps · Routurier		D7
0100-23	Extracting forceps		D7
0100-24	Extracting forceps		D7
0100-29	Extracting forceps		D7
0100-29N	Extracting forceps		D7
0100-30	Extracting forceps		D8
0100-31	Extracting forceps		D8
0100-33	Extracting forceps		D8
0100-33A	Extracting forceps		D8
0100-33L	Extracting forceps		D8
0100-38A	Extracting forceps		D8
0100-41	Extracting forceps		D8
0100-43A	Extracting forceps		D9
0100-44	Extracting forceps		D9
0100-45	Extracting forceps		D9
0100-46	Extracting forceps		D9
0100-46L	Extracting forceps		D9
0100-48	Extracting forceps		D10
0100-49	Extracting forceps		D10
0100-51	Extracting forceps		D10
0100-51A	Extracting forceps		D10
0100-51L	Extracting forceps		D10
0100-51LX	Extracting forceps		D11
0100-52	Extracting forceps		D11
0100-54	Extracting forceps		D11
0100-55	Extracting forceps		D11
0100-56	Extracting forceps		D11
0100-59	Extracting forceps		D11
0100-59L	Extracting forceps		D11
0100-60	Extracting forceps		D12
0100-65L	Extracting forceps		D12
0100-65R	Extracting forceps		D12
0100-66L	Extracting forceps		D12
0100-66R	Extracting forceps		D13
0100-67	Extracting forceps		D13
0100-67/L	Extracting forceps		D13
0100-67/R	Extracting forceps		D13
0100-67A	Extracting forceps		D13
0100-68	Extracting forceps		D14
0100-73	Extracting forceps		D14
0100-74	Extracting forceps		D14
0100-74M	Extracting forceps		D14
0100-74N	Extracting forceps		D14

CODE	DESCRIPTION	HANDLE	PAGE
0100-75	Extracting forceps		D15
0100-79	Extracting forceps		D15
0100-79A	Extracting forceps		D15
0100-79C	Extracting forceps		D15
0100-86/L	Extracting forceps · Routurier		D16
0100-86/R	Extracting forceps · Routurier		D16
0100-86C	Extracting forceps		D16
0100-86W	Extracting forceps · White		D17
0100-87	Extracting forceps		D17
0100-89	Extracting forceps		D18
0100-90	Extracting forceps		D18
0100-99	Extracting forceps		D18
0100-107	Extracting forceps		D19
0100-121	Extracting forceps · Ogden-Felsch		D19
0100-145	Extracting forceps		D19
0100-151/	Extracting forceps		D19
0100-166	Extracting forceps · Trotter		D17
0100-167	Extracting forceps · Trotter		D20
0100-168	Extracting forceps · Trotter		D19
0100-169	Extracting forceps · Trotter		D20
0100-346	Extracting forceps		D19
0100-349	Extracting forceps		D20
0100-359	Extracting forceps		D20
0101-1	Extracting forceps for roots · Witzel		D40
0101-2	Extracting forceps for roots · Witzel		D40
0102-1	Extracting forceps for root splinters and silver cones · Stieglitz		D41, G3
0102-2	Extracting forceps for root splinters and silver cones · Stieglitz		D41, G3
0103-10	Bone rongeurs · Luer		D42, E30
0103-20	Bone rongeurs · Friedman		D42
0103-25	Bone rongeurs · Mini Friedman		D42, E30, H30
0103-30	Bone rongeurs · Blumenthal		D43, E30
0103-31	Bone rongeurs · Blumenthal		D43, E30
0103-32	Bone rongeurs · Blumenthal		D43
0103-40	Bone rongeurs · Cleveland		D42
0103-45	Bone rongeurs · Cleveland-Gardner		D42
0103-50	Bone rongeurs · Mead		D43
0103-60	Bone/soft tissue nippers · Goldman-Fox		D44, E29, H30
0103-70	Bone rongeurs · Mini-Ruskin		D44
0103-71	Bone rongeurs · Beyer		D44
0103-78	Gum guillotine forceps · Tomati		H30
0104-1	Extracting forceps · Mead		D24
0104-2	Extracting forceps · Mead		D24
0104-3	Extracting forceps · Mead		D24
0104-4	Extracting forceps · Mead		D24
0110-13S	Extracting forceps for children		D37
0110-22S	Extracting forceps for children		D37
0110-30S	Extracting forceps for children		D37
0110-33S	Extracting forceps for children		D37
0110-37	Extracting forceps for children		D37
0110-38	Extracting forceps for children		D38
0110-39	Extracting forceps for children		D38
0110-39L	Extracting forceps for children		D38
0110-39R	Extracting forceps for children		D38
0110-51S	Extracting forceps for children		D38
0112-1	Extracting forceps for children · Klein		D39
0112-2	Extracting forceps for children · Klein		D39
0112-3	Extracting forceps for children · Klein		D39
0112-4	Extracting forceps for children · Klein		D39
0112-5	Extracting forceps for children · Klein		D39
0112-6	Extracting forceps for children · Klein		D39
0112-7	Extracting forceps for children · Klein		D39
0120-5	Extracting forceps - American pattern · Physick		D25
0120-6	Extracting forceps - American pattern		D25
0120-10S	Extracting forceps - American pattern		D25
0120-16	Extracting forceps - American pattern		D25

CODE	DESCRIPTION	HANDLE	PAGE
0120-17	Extracting forceps - American pattern		D25
0120-18L	Extracting forceps - American pattern · Harris		D26
0120-18R	Extracting forceps - American pattern · Harris		D26
0120-23	Extracting forceps - American pattern		D26
0120-53L	Extracting forceps - American pattern		D26
0120-53R	Extracting forceps - American pattern		D26
0120-65	Extracting forceps - American pattern		D27
0120-69	Extracting forceps - American pattern · Tomes		D27
0120-88L	Extracting forceps - American pattern · Nevius		D27
0120-88R	Extracting forceps - American pattern · Nevius		D27
0120-101	Extracting forceps - American pattern · Hull		D27
0120-150	Extracting forceps - American pattern · Cryer		D28
0120-150S	Extracting forceps - American pattern · Cryer		D28
0120-151	Extracting forceps - American pattern · Cryer		D28
0120-151S	Extracting forceps - American pattern · Cryer		D28
0120-222	Extracting forceps - American pattern		D28
0130-1	Extracting forceps · anatomic handle		D33
0130-2	Extracting forceps · anatomic handle		D33
0130-4	Extracting forceps · anatomic handle		D33
0130-7	Extracting forceps · anatomic handle		D33
0130-13	Extracting forceps · anatomic handle		D33
0130-17	Extracting forceps · anatomic handle		D34
0130-18	Extracting forceps · anatomic handle		D34
0130-21	Extracting forceps · anatomic handle		D34
0130-22	Extracting forceps · anatomic handle		D34
0130-33	Extracting forceps · anatomic handle		D34
0130-45	Extracting forceps · anatomic handle		D34
0130-51A	Extracting forceps · anatomic handle		D34
0130-67A	Extracting forceps · anatomic handle		D35
0130-74	Extracting forceps · anatomic handle		D35
0130-79	Extracting forceps · anatomic handle		D35
0130-86C	Extracting forceps · anatomic handle		D35
0130-89	Extracting forceps · anatomic handle		D36
0130-90	Extracting forceps · anatomic handle		D36
0130-145	Extracting forceps · anatomic handle		D36
0130-151/	Extracting forceps · anatomic handle		D36
0130-349	Extracting forceps · anatomic handle		D36
0130-359	Extracting forceps · anatomic handle		D36
0200-1	Root elevators · Bein		D49
0200-2	Root elevators · Bein		D49
0200-3	Root elevators · Bein		D49
0200-4	Root elevators · Bein		D49
0200-5	Root elevators · Bein		D49
0200-6	Root elevators · Bein		D49
0201-1	Root elevators · Flohr		D51
0201-2	Root elevators · Flohr		D51
0201-3	Root elevators · Flohr		D51
0202-320	Root elevators · Walter F. Barry		D63
0202-321	Root elevators · Walter F. Barry		D63
0202-322	Root elevators · Walter F. Barry		D63
0202-323	Root elevators · Walter F. Barry		D63
0202-350	Root elevators · Walter F. Barry		D63
0202-351	Root elevators · Walter F. Barry		D63
0202-370	Root elevators · Walter F. Barry		D63
0202-371	Root elevators · Walter F. Barry		D63
0203-1	Root elevators · Lecluse		D65
0203-24	Root elevators · Pott		D65
0203-25	Root elevators · Pott		D65
0204-1L	Root elevators · Winter		D64
0204-1R	Root elevators · Winter		D64
0204-11L	Root elevators · Winter		D64
0204-11R	Root elevators · Winter		D64
0204-12L	Root elevators · Winter		D64
0204-12R	Root elevators · Winter		D64
0204-14L	Root elevators · Winter		D64

CODE	DESCRIPTION	HANDLE	PAGE
0204-14R	Root elevators · Winter		D64
0205-4	Root elevators · Schmeckebier-Apexo		D51
0205-5	Root elevators · Schmeckebier-Apexo		D51
0205-4B	Root elevators · Schmeckebier-Apexo		D51
0205-5B	Root elevators · Schmeckebier-Apexo		D51
0206-71	Root elevators · Miller-Apexo		D54
0206-72	Root elevators · Miller-Apexo		D54
0206-73	Root elevators · Miller-Apexo		D54
0206-74	Root elevators · Miller-Apexo		D54
0207-19	Root elevators		D54
0207-20	Root elevators		D54
0208-2S	Root elevators · Seldin		D54
0208-3S	Root elevators · Seldin		D54
0208-34	Root elevators · Seldin		D54
0208-34S	Root elevators · Seldin		D54
0209-1L	Root elevators · Seldin		D55
0209-1R	Root elevators · Seldin		D55
0209-4L	Root elevators · Seldin		D55
0209-4R	Root elevators · Seldin		D55
0210-51	Root elevators · Curtis		D55
0210-52	Root elevators · Curtis		D55
0211-11	Root elevators · Stout		D55
0211-11A	Root elevators · Stout		D55
0213-12	Root elevators		D55
0214-A	Root elevators · Cogswell		D56
0215-301	Root elevators · Apexo		D56
0215-302	Root elevators · Apexo		D56
0215-303	Root elevators · Apexo		D56
0216-01W	Root elevators · Seldin		D56
0216-04W	Root elevators · Seldin		D56
0217-1	Root elevators · Heidbrink		D56
0217-2	Root elevators · Heidbrink		D56
0217-40	Root elevators · Heidbrink		D56
0217-41	Root elevators · Heidbrink		D56
0218-1	Root elevators		D53
0218-2	Root elevators		D53
0218-3	Root elevators		D53
0218-4	Root elevators		D53
0218-81A	Root elevators		D58
0219-1	Root elevators		D53
0219-2	Root elevators		D53
0220-25	Root elevators · Cryer		D57
0220-26	Root elevators · Cryer		D57
0220-31	Root elevators · Cryer		D57
0220-32	Root elevators · Cryer		D57
0220-44	Root elevators · Cryer		D57
0220-45	Root elevators · Cryer		D57
0221-A1C	Root elevators · Coupland		D58
0221-A2C	Root elevators · Coupland		D58
0221-A3C	Root elevators · Coupland		D58
0222-190	Root elevators		D58
0222-191	Root elevators		D58
0223-15	Root elevators · Woodward		D58
0223-16	Root elevators · Woodward		D58
0228-31F	Root elevators · Friedman		D59
0228-32F	Root elevators · Friedman		D59
0229-1C	Root elevators · Coupland		D60
0229-1F	Root elevators · Friedman		D59
0229-2C	Root elevators · Coupland		D60
0229-2F	Root elevators · Friedman		D59
0229-3C	Root elevators · Coupland		D60
0230-11M	Root elevators · Mac Millan		D58
0230-12M	Root elevators · Mac Millan		D58
0230-13M	Root elevators · Mac Millan		D58
0231-2	Root elevators · London Hospital		D48

CODE	DESCRIPTION	HANDLE	PAGE
0231-3	Root elevators · London Hospital		D48
0232-1	Root elevators · Coleman		D48
0233-1	Root elevators		D48
0233-2	Root elevators		D48
0234-1	Root elevators · Hylin		D45
0234-2	Root elevators · Hylin		D45
0234-3	Root elevators · Hylin		D45
0234-4	Root elevators · Hylin		D45
0240-1	Root elevators · Bein		D50
0240-2	Root elevators · Bein		D50
0240-3	Root elevators · Bein		D50
0240-4	Root elevators · Bein		D50
0240-5	Root elevators · Bein		D50
0240-6	Root elevators · Bein		D50
0241-2	Root elevators · Flohr		D60
0241-3	Root elevators · Flohr		D60
0242-1	Root elevators		D60
0242-2	Root elevators		D60
0243-7	Root elevators · Cryer		D57
0243-8	Root elevators · Cryer		D57
0244-1	Root elevators · Kopp		D52
0244-2	Root elevators · Kopp		D52
0244-3	Root elevators · Kopp		D52
0244-4	Root elevators · Kopp		D52
0244-5	Root elevators · Kopp		D52
0244-6	Root elevators · Kopp		D52
0250-1	Root elevators · Bein		D61
0250-2	Root elevators · Bein		D61
0250-3	Root elevators · Bein		D61
0250-4	Root elevators · Bein		D61
0250-5	Root elevators · Bein		D61
0250-6	Root elevators · Bein		D61
0251-1	Root elevators · Flohr		D61
0251-2	Root elevators · Flohr		D61
0251-3	Root elevators · Flohr		D61
0255-4	Root elevators · Schmeckebier-Apexo		D61
0255-5	Root elevators · Schmeckebier-Apexo		D61
0256-71	Root elevators · Miller-Apexo		D62
0256-72	Root elevators · Miller-Apexo		D62
0259-4L	Root elevators · Seldin		D62
0259-4R	Root elevators · Seldin		D62
0265-301	Root elevators · Apexo		D62
0266-01W	Root elevators · Seldin		D62
0267-1	Root elevators · Heidbrink		D62
0267-2	Root elevators · Heidbrink		D62
0267-41	Root elevators · Heidbrink		D62
0270-25	Root elevators · Cryer		D62
0270-26	Root elevators · Cryer		D62
0270-44	Root elevators · Cryer		D62
0270-45	Root elevators · Cryer		D62
0280-2R	Ideal · straight root elevator Fig. 2R		D46
0280-3C	Ideal · curved root elevator Fig. 3C		D46
0280-3DF	Ideal · root elevator Fig. 3DF		D47
0280-3R	Ideal · straight root elevator Fig. 3R		D46
0280-5C	Ideal · curved root elevator Fig. 5C		D47
0280-5DF	Ideal · straight root elevator Fig. 5R		D47
0280-5R	Ideal · root elevator Fig. 5DF		D46
0290-1	Root-tip picks · Heidbrink		D66
0290-2	Root-tip picks · Heidbrink		D66
0290-3	Root-tip picks · Heidbrink		D66
0291-1	Root elevators · Heidbrink		D65
0291-2	Root elevators · Heidbrink		D65
0291-3	Root elevators · Heidbrink		D65
0291-1F	Root elevators · Mini Friedman		D59
0291-2F	Root elevators · Mini Friedman		D59

CODE	DESCRIPTION	HANDLE	PAGE
0294-1	Root-tip picks · Warwick-James		D66
0294-2	Root-tip picks · Warwick-James		D66
0294-3	Root-tip picks · Warwick-James		D66
0295-1	Syndesmotomes · Chompret		D67
0295-2	Syndesmotomes · Chompret		D67
0295-3	Syndesmotomes · Chompret		D67
0295-4	Syndesmotomes · Chompret		D67
0296-0	Syndesmotomes · tip		D68
0296-1	Syndesmotomes · tip		D68
0296-2	Syndesmotomes · tip		D68
0296-3	Syndesmotomes · tip		D68
0296-4	Syndesmotomes · tip		D68
0296-5	Syndesmotomes · tip		D68
0296-6	Syndesmotomes · tip		D68
0296-7	Syndesmotomes · tip		D68
0296-8	Syndesmotomes · tip		D68
0296-9	Syndesmotomes · tip		D68
0296-11	Syndesmotomes · tip		D68
0296-21	Syndesmotomes · tip		D68
0296-22	Syndesmotomes · tip		D69
0296-23	Syndesmotomes · tip		D69
0296-24	Syndesmotomes · tip		D69
0296-25	Syndesmotomes · tip		D69
0296-26	Syndesmotomes · tip		D69
0296-27	Syndesmotomes · tip		D69
0296-28	Syndesmotomes · tip		D69
0296-29	Syndesmotomes · tip		D69
0296-M	Syndesmotomes · handle		D68
0297-1	Instrument kit for syndesmotomes		D71
0300-1	Gum scissors · straight		C3, F47, L28
0300-2	Gum scissors · curved		C3, L28
0301-1	Gum scissors · angular		C3
0301-2	Gum scissors · angular, one blade serrated		C3
0302-1	Gum scissors · curved · Neumann		C7
0303-1	Gum scissors · curved, very thin beaks · Noyes (Castroviejo)		C7
0304-1	Gum scissors · straight, one blade serrated · Goldman-Fox		C3, E4
0304-1TC	Gum scissors · straight · Goldman-Fox		C4
0304-2	Gum scissors · curved, one blade serrated · Goldman-Fox		C3, E4
0304-2TC	Gum scissors · curved · Goldman-Fox		C4
0304-3	Gum scissors · curved, one blade serrated · Goldman-Fox (special)		C4
0305-1	Gum scissors · straight · Iris		C4
0305-1TC	Gum scissors · straight · Iris		C4
0305-2	Gum scissors · curved · Iris		C4
0305-2TC	Gum scissors · straight · Iris		C4
0305-3	Gum scissors · curved · Iris		C5
0306-1	Gum scissors · curved, one blade serrated · Dean		C7
0306-1TC	Gum scissors · curved · Goldman-Fox		C4
0307-1	Gum scissors · curved, one blade serrated · La Grange		C7
0308-1	Gum scissors · straight · Quinby		C5
0308-2	Gum scissors · curved · Quinby		C5
0309-1	Gum scissors · straight · Kelly		C5
0309-1TC	Gum scissors · straight · Kelly		C5, E4
0309-2	Gum scissors · curved · Kelly		C5
0309-2TC	Gum scissors · curved · Kelly		C5, E4
0310-1	Gum scissors · angular, one blade serrated · Locklin		C6
0310-1TC	Gum scissors · angular · Locklin		C6
0310-2	Gum scissors · angular, one blade serrated · Locklin		C6
0310-2TC	Gum scissors · angular · Locklin		C6
0311-1	Gum scissors · straight, one blade serrated · Sullivan		C6
0311-2	Gum scissors · curved, one blade serrated · Sullivan		C6
0312-1	Gum scissors · curved, sharp beaks · Westcott		C7, G19
0312-2	Gum scissors · curved, blunt beaks · Westcott		C7
0313-1	Gum scissors · curved, very thin beaks		C7
0320-1	Gum scissors · suture · Spencer		C8
0320-2	Gum scissors · suture · Spencer		C8

CODE	DESCRIPTION	HANDLE	PAGE
0321-1	Gum scissors - dissecting - straight - Metzenbaum		C8
0321-2	Gum scissors - dissecting - curved - Metzenbaum		C8
0322-1	Gum scissors - dissecting - straight - Metzenbaum-Delikat		C8, E4
0322-2	Gum scissors - dissecting - curved - Metzenbaum-Delikat		C8, E4
0325-1	Gum scissors - suture - straight - Mayo		C8
0325-2	Gum scissors - suture - curved - Mayo		C8
0328-1	Gum scissors - suture - straight - Stevens		C9
0328-2	Gum scissors - suture - curved - Stevens		C9
0329-1	Gum scissors - suture - rounded straight beaks - Stevens		C9
0329-2	Gum scissors - suture - rounded curved beaks - Stevens		C9
0330-1	Gum scissors - suture - straight - Stevens		C9
0330-2	Gum scissors - suture - curved - Stevens		C9
0335-1	Scalpel handles - orientable blade		C24, E9
0350-3	Scalpel handles - double cutting edge		C26, E7
0350-3G	Scalpel handles		C26, E7
0350-5	Scalpel handles		C26, E8
0350-5A	Scalpel handles		C26, E8
0350-7	Scalpel handles		C26, E7
0350-8	Scalpel handles		C26, E7
0351-10	Scalpel blades		C26, E8
0351-11	Scalpel blades		C26, E8
0351-12	Scalpel blades		C26, E8
0351-12D	Scalpel blades - double cutting edge		C26, E8
0351-15	Scalpel blades		C26, E8
0351-15C	Scalpel blades		C26, E8
0352	Scalpel blade remover		C24, E9
0360-4	Scalpel handles		C27
0361-20	Scalpel blades		C27
0361-21	Scalpel blades		C27
0361-22	Scalpel blades		C27
0361-23	Scalpel blades		C27
0361-24	Scalpel blades		C27
0365-1	Micro-blades		C27, E9, G16
0366-4	Micro-blades		C27, E9
0366-7	Micro-blades		C27, E9
0371-10	Disposable scalpels		C25, E10
0371-11	Disposable scalpels		C25, E10
0371-12	Disposable scalpels		C25, E10
0371-15	Disposable scalpels		C25, E10
0400-14	Needle holders - scissors combined - Olsen-Hegar		C10
0401-12	Needle holders - Derf		C13
0403-17	Needle holders - Adson		C10
0404-14	Needle holders - Baumgartner		C11
0405-14TC	Needle holders - Olsen-Hegar		C10
0406-12TC	Needle holders - Derf		C13
0407-13TC	Needle holders - smooth jaws - Halsey-Smooth		C13
0408-13TC	Needle holders - Halsey		C13
0409-14TC	Needle holders - Hegar-Baumgartner		C11
0410-15	Needle holders - Crile-Wood		C10
0414-16	Needle holders - scissors combined - Gillies		C14
0415-15TC	Needle holders - Crile-Wood		C10
0416-15TC	Needle holders - Mini-Ryder		C13
0416-18TC	Needle holders - Mini-Ryder		C13
0417-15TC	Needle holders - Fine Swedish		C14
0418-15TC	Needle holders - Micro-Vascular		C14
0419-16TC	Needle holders - scissors combined - Gillies		C14
0420-16	Needle holders - Mayo-Hegar		C12
0420-18	Needle holders - Mayo-Hegar		C12
0421-18	Needle holders - light pattern - Toennis		C14
0422-19	Needle holders - Eiselberg-Mathieu		C15
0425-16TC	Needle holders - Mayo-Hegar		C12
0425-18TC	Needle holders - Mayo-Hegar		C12
0426-18TC	Needle holders - light pattern - Toennis		C14
0430-14	Needle holders - Mathieu		C16
0430-17	Needle holders - Mathieu		C16

CODE	DESCRIPTION	HANDLE	PAGE
0431-14	Needle holders - Mathieu		C16
0431-17	Needle holders - Mathieu		C16
0432-14	Needle holders - scissors combined - Mathieu		C16
0432-14TC	Needle holders - Mathieu		C16
0432-17	Needle holders - smooth action - Lichtenberg		C15
0433-16	Needle holders - Arruga		C15
0435-14TC	Needle holders - Mathieu		C17, E5
0435-17TC	Needle holders - Mathieu		C17, E5
0436-14TC	Needle holders - Mathieu		C17
0436-17TC	Needle holders - Mathieu		C17
0437-17TC	Needle holders - Lichtenberg		C15, E5
0438-16TC	Needle holders - Arruga		C15
0440TH-14	Needle holders - Castroviejo		C18
0440TH-18	Needle holders - Castroviejo		C19
0441TH-14	Needle holders - with curved jaws - Castroviejo		C18
0441TH-18	Needle holders - with curved jaws - Castroviejo		C19
0442TH-13	Needle holders - Castroviejo		C19
0442TH-13L	Needle holders - smooth jaws - Castroviejo		C19
0443TH-14	Needle holders - Castroviejo		C18
0444TH-12L	Needle holders - smooth jaws - Castroviejo-Barraquer		C19
0445TH-14TC	Needle holders - Castroviejo		C18, E5, G19
0445TH-18TC	Needle holders - Castroviejo		C19
0446TH-14TC	Needle holders - Castroviejo		C18, E5
0446TH-18TC	Needle holders - Castroviejo		C19
0447TH-13TC	Needle holders - Castroviejo		C19
0448TH-14TC	Needle holders - Castroviejo		C18, E5
0450TH-18TC	Needle holders - Micro-Barraquer		C17, E6
0451TH-18TC	Needle holders - with curved jaws - Micro-Barraquer		C17, E6
0480-1	Syringes - cork screw tip, metric thread		C29
0480-2	Syringes - cork screw tip, metric thread		C29
0480-3	Syringes - cork screw tip, metric thread		C29
0480-4	Syringes - cork screw tip, metric thread		C29
0480-4W	Syringes - cork screw tip, imperial thread (Whitworth)		C29
0480-5	Syringes - self-aspirating, metric thread		C28
0480-6	Syringes - self-aspirating, metric thread		C28
0480-P1	Syringes - spare caps for syringes, metric thread		C29
0480-P2	Syringes - spare caps for syringes, imperial thread (Whitworth)		C29
0481-7	Syringes - intra-ligamental, metric thread		C30
0481-8	Syringes - intra-ligamental, metric thread		C30
0481-T1	Syringes - autoclavable plastic protection sleeve		C30
0482-1	Syringes - syringe stand		C30
0482-3W	Syringes - non self-aspirating, imperial thread (Whitworth)		C28
0482-4W	Syringes - non self-aspirating, imperial thread (Whitworth)		C28
0482-6W	Syringes - self-aspirating, imperial thread (Whitworth)		C28
0482-7W	Syringes - intra-ligamental, imperial thread (Whitworth)		C30
0483-1	Syringes - self-aspirating, metric thread		C28
0483-2	Syringes - non self-aspirating, metric thread		C28
0483-3	Syringes - non self-aspirating, metric thread		C28
0490-1	Bone injectors		E27
0490-2	Bone injectors		E27
0491-1	Bone thickness gauge		E31
0491-2	Bone thickness gauge		E31
0493-1	Aspirators		E33
0493-2	Filter for aspirators		E33
0493-5	Aspirators		E33
0494-1	Bone scrapers - straight		E28
0494-1R	Bone scrapers - straight		E28
0494-2	Bone scrapers - curved		E28
0494-2R	Bone scrapers - straight		E28
0495-1	Osteotomes		E19
0495-2	Osteotomes		E19
0495-3	Osteotomes		E19
0495-4	Osteotomes		E19
0495-5	Osteotomes		E19
0495-6	Osteotomes		E19

CODE	DESCRIPTION	HANDLE	PAGE
0496-1P	Osteotomes		E20
0496-2P	Osteotomes		E20
0496-3P	Osteotomes		E20
0496-4P	Osteotomes		E20
0497-1T	Osteotomes		E20
0497-2T	Osteotomes		E20
0497-3T	Osteotomes		E20
0498-1B3	Osteotomes		E18
0498-1B33	Osteotomes		E18
0498-1B4	Osteotomes		E18
0498-1B5	Osteotomes		E18
0498-2C3	Osteotomes		E18
0498-2C33	Osteotomes		E18
0498-2C4	Osteotomes		E18
0498-2C5	Osteotomes		E18
0498-30B3	Osteotomes		E18
0498-30B33	Osteotomes		E18
0498-30B4	Osteotomes		E18
0498-30B5	Osteotomes		E18
0498-PF3	Osteotomes		E18
0498-PF33	Osteotomes		E18
0498-PF4	Osteotomes		E18
0498-PF5	Osteotomes		E18
0500-1	Hemostats · straight · Halstead-Mosquito		C21, F46
0500-2	Hemostats · curved · Halstead-Mosquito		C21, G19
0501-1	Hemostats · straight · Micro-Mosquito		C22, F46
0501-2	Hemostats · curved · Micro-Mosquito		C22
0505-1	Hemostats · straight · Halstead-Mosquito 1x2		C21
0505-2	Hemostats · curved · Halstead-Mosquito 1x2		C21
0506-1	Hemostats · straight · Micro-Mosquito 1x2		C22
0506-2	Hemostats · curved · Micro-Mosquito 1x2		C22
0507-1	Elastic forceps · straight · Halstead-Mosquito		I36
0507-2	Elastic forceps · curved · Halstead-Mosquito		I36
0510-1	Hemostats · straight · Kelly		C23, F46
0510-2	Hemostats · curved · Kelly		C23
0515-1	Hemostats · straight · Hartmann		C23
0515-2	Hemostats · curved · Hartmann		C23
0520-1	Hemostats · straight · Crile		C20
0520-2	Hemostats · curved · Crile		C20
0530-1	Hemostats · straight · Kocher 1x2		C20
0530-2	Hemostats · curved · Kocher 1x2		C20
0540-1	Hemostats · straight · Pean		C20
0540-2	Hemostats · curved · Pean		C20
0545-1	Crown instruments		L29
0550-1	Towel clamps · Backhaus		C31
0550-2	Towel clamps · Backhaus		C31
0550-3	Towel clamps · Backhaus		C31
0555-1	Dressing forceps · straight · Gross-Maier		C32
0555-2	Dressing forceps · curved · Gross-Maier		C32
0557-1	Dressing forceps · straight · Gross-Maier		C32
0557-2	Dressing forceps · curved · Gross-Maier		C32
0560	Tongue forceps · Collin		C33
0561	Tongue forceps · Young		C33
0561-R	Tongue forceps		C33
0565-1	Sterilizing forceps		J15
0565-2	Sterilizing forceps		J15
0600-2	Cotton and dressing pliers · London-College		B4
0600-3	Cotton and dressing pliers		B5
0600-4	Cotton and dressing pliers · Perry		B4
0600-17	Cotton and dressing pliers		B5
0600-18	Cotton and dressing pliers		B5
0600-18L	Cotton and dressing pliers		B3
0600-19	Cotton and dressing pliers		B5
0601-1	Cotton and dressing pliers · Flagg		B4
0601-2	Cotton and dressing pliers · London-College		B4

CODE	DESCRIPTION	HANDLE	PAGE
0601-3	Cotton and dressing pliers · Meriam		B4, L19
0601-4	Cotton and dressing pliers · Perry		B4
0601-5	Cotton and dressing pliers · Perry		B4
0602-1	Cotton and dressing pliers		B3
0602-2	Cotton and dressing pliers		B3
0620-1	Tissue pliers · Adson		C38, E36
0621-1	Tissue pliers · Adson 1x2		C38, E36
0622-1	Tissue pliers · Micro-Adson 1x2		C38, G18
0622-2	Tissue pliers · Micro-Adson 1x2		C39
0623-1	Tissue pliers		C39
0624-1	Tissue pliers · Micro-Adson		C39, G18
0624-2	Tissue pliers · Micro-Adson		C39
0625-1	Suture pliers		C40
0626-1	Tissue pliers · non traumatic · Adson Brown		C41
0630-1	Tissue pliers · Semken-Taylor		C41, E36
0630-2	Tissue pliers · Semken-Taylor		C41, E36
0631-1	Tissue pliers · Semken-Taylor 1x2		C41
0631-2	Tissue pliers · Semken-Taylor 1x2		C41
0635-1	Tissue pliers		C43
0635-2	Tissue pliers		C43
0635-3	Tissue pliers		C43, L19
0635-4	Tissue pliers		C43, L19
0635-5	Tissue pliers		C43
0635-6	Laboratory tweezers		L19
0645-1	Tissue pliers		C42
0645-2	Tissue pliers		C42, L19
0645-3	Tissue pliers		C42, L19
0645-4	Tissue pliers		C42
0645-5	Tissue pliers		C42
0650-1	Periodontal pocket markers · Goldman-Fox (Crane-Kaplan)		B3, E35, H31
0650-2	Periodontal pocket markers · Goldman-Fox (Crane-Kaplan)		B3, E35, H31
0660-1	Membrane holding tweezers		E37
0660-2	Membrane holding tweezers · with delicate ring tips		E37
0661-1	Implant holding tweezers		E37
0661-2	Implant holding tweezers		E37
0661-3	Implant holding tweezers		E37
0670	Articulating paper forceps · Miller		F44
0671	Articulating paper forceps		F44
0680	Towel clamps · Schaedle		C31
0681	Towel clamps · Jones		C31
0690	Ultralight Mirrors		B21
0690-G	Ultralight Mirrors		B21
0690-L	Ultralight Mirrors		B21
0690-M	Ultralight Mirrors		B21
0690-T	Ultralight Mirrors		B21
0691	Ultralight Retractors		B21
0700-2	Single-ended Explorers	Asa60	B6
0700-3	Single-ended Explorers	Asa60	B6
0700-3A	Single-ended Explorers	Asa60	B6
0700-3R	Single-ended Explorers · Rhein	Asa60	B6
0700-5	Single-ended Explorers	Asa60	B6
0700-6	Single-ended Explorers	Asa60	B6
0700-8	Single-ended Explorers	Asa60	B6
0700-9	Single-ended Explorers	Asa60	B6
0700-10	Single-ended Explorers	Asa60	B6
0700-11	Single-ended Explorers	Asa60	B6
0700-12	Single-ended Explorers	Asa60	B6
0700-16	Single-ended Explorers	Asa60	B6
0700-17	Single-ended Explorers	Asa60	B6
0700-17A	Single-ended Explorers	Asa60	B6
0700-23	Single-ended Explorers	Asa60	B6
0701-2	Single-ended Explorers	Asa60M	B6
0701-3	Single-ended Explorers	Asa60M	B6
0701-5	Single-ended Explorers	Asa60M	B6
0701-6	Single-ended Explorers	Asa60M	B6

CODE	DESCRIPTION	HANDLE	PAGE
0701-8	Single-ended Explorers	Asa60M	B6
0701-9	Single-ended Explorers	Asa60M	B6
0701-10	Single-ended Explorers	Asa60M	B6
0701-11	Single-ended Explorers	Asa60M	B6
0701-12	Single-ended Explorers	Asa60M	B6
0701-16	Single-ended Explorers	Asa60M	B6
0701-17	Single-ended Explorers	Asa60M	B6
0701-17A	Single-ended Explorers	Asa60M	B6
0701-23	Single-ended Explorers	Asa60	B6
0701-3A	Single-ended Explorers	Asa60M	B6
0702L-11	Periodontal pocket Probes	Asa60	E32, H3
0702L-12	Periodontal pocket Probes	Asa60	E32, H3
0702L-12S	Periodontal pocket Probes	Asa60	E32, H3
0702L-15	Periodontal pocket Probes	Asa60	G17, H3
0702-C	Periodontal pocket Probes	Asa35	H3
0703L-1	Periodontal pocket Probes · Williams	Asa60	H3
0703L-2	Periodontal pocket Probes · Merrit A	Asa60	H3
0703L-3	Periodontal pocket Probes · Merrit B	Asa60	H3
0703L-4	Periodontal pocket Probes · Goldman-Fox	Asa60	H3
0703L-5	Periodontal pocket Probes · University of Michigan	Asa60	H3
0703L-6	Periodontal pocket Probes	Asa60	H3
0704-6D9	Double-ended explorers	Asa60	B8
0704-11/12AF	Double-ended explorers	Asa60	B8
0704-16D1	Double-ended explorers	Asa60	B8
0704-16D2	Double-ended explorers · Asa Com 2/2B	Asa60	B8, F50
0704-23D1	Double-ended explorers	Asa60	B8
0704-23D2	Double-ended explorers	Asa60	B8
0704-UT1	Double-ended explorers · Cattoni	Asa60	B8
0705L-3GF	Root canal Explorers · Goldman-Fox	Asa60	B10
0705L-16GF	Expros (combination explorers/probes) · Goldman-Fox	Asa60	B10
0705L-16W	Expros (combination explorers/probes) · Williams	Asa60	B10
0705L-17GF	Expros (combination explorers/probes) · Goldman-Fox	Asa60	B10
0705L-17UM	Expros (combination explorers/probes) · University of Michigan	Asa60	B10
0705L-17W	Expros (combination explorers/probes) · Williams	Asa60	B10
0705L-23GF	Expros (combination explorers/probes) · Goldman-Fox	Asa60	B10
0705L-23UM	Expros (combination explorers/probes) · University of Michigan	Asa60	B10
0705L-23W	Expros (combination explorers/probes) · Williams	Asa60	B10
0706L-2311	Expros (combination explorers/probes)	Asa60	B10
0706L-2312	Expros (combination explorers/probes)	Asa60	B10
0707L-GFW	Expros (combination explorers/probes) · Goldman-Fox Williams	Asa60	B11
0708-1N	Double-ended explorers · Nabers	Asa60	B11
0708-2N	Double-ended explorers · Nabers	Asa60	B11
0708L-2N	Double-ended explorers · Nabers	Asa60	B11
0709-2	Double-ended explorers	Asa60	B8
0709-2A	Double-ended explorers	Asa60	B8
0709-3	Double-ended explorers	Asa60	B9
0710-6D1	Root canal Explorers	Asa60	B9
0710-6D2	Root canal Explorers	Asa60	B9
0710-6D3	Root canal Explorers	Asa60	B9
0800-1	Root canal Spreaders	Asa60	B12, G4
0800-2	Root canal Spreaders	Asa60	B12, G4
0800-3	Root canal Spreaders	Asa60	B12, G4
0800-4	Root canal Spreaders	Asa60	B12, G4
0800-5	Root canal Spreaders	Asa60	B12, G4
0800-6	Root canal Spreaders	Asa60	B12, G4
0800-7	Root canal Spreaders	Asa60	B12, G4
0800	Ruler for endodontics		B15, G7
0801-1	Root canal Pluggers · Luks	Asa60	B13, G5
0801-2	Root canal Pluggers	Asa60	B13, G5
0801-3	Root canal Pluggers · Luks	Asa60	B13, G5
0801-4	Root canal Pluggers · Luks	Asa60	B13, G5
0802L-1	Vertical condensers	Asa60	B15, G7
0802L-2	Vertical condensers	Asa60	B15, G7
0802L-3	Vertical condensers	Asa60	B15, G7
0802L-4	Vertical condensers	Asa60	B15, G7

CODE	DESCRIPTION	HANDLE	PAGE
0870-1	Pliers for removing broken broaches		G2
0870-2	Pliers for removing broken broaches		G2
0900-1	Cement spatulas		F25
0900-2	Cement spatulas		F25
0903-0	Cement spatulas		F25
0903-00	Cement spatulas		F25
0903-1	Cement spatulas		F25
0903-2	Cement spatulas		F25
0903-3	Cement spatulas		F25
0903-4	Cement spatulas		F25
0999-1	Glass plate for mixing		F25
1009-1	Amalgam carriers · straight for retrogrades		F24
1009-2	Amalgam carriers · curved for retrogrades		F24
1009-3	Amalgam carriers · straight for retrogrades		F24
1009-4	Amalgam carriers · curved for retrogrades		F24
1011-1	Amalgam carriers · small		F23
1011-2	Amalgam carriers · medium		F23
1011-3	Amalgam carriers · large		F23
1011-4	Amalgam carriers · jumbo		F23
1015-1	Amalgam carriers · medium/small		F23
1015-2	Amalgam carriers · medium/large		F23
1015-3	Amalgam carriers · medium/jumbo		F23
1020-1	Amalgam carriers · straight		F24
1020-2	Amalgam carriers · 45°		F24
1020-2P	Amalgam carriers		F24
1020-3	Amalgam carriers · 90°		F24
1030-1	Amalgam wells		F23
1030-2	Amalgam wells		F23
1030-3	Amalgam wells		F23
1030-4	Bone wells		E32
1100-1	Heidemann separating spatulas		F26
1100-2	Heidemann separating spatulas		F26
1100-3	Heidemann separating spatulas		F26
1101-1	Heidemann separating spatulas		F26
1101-2	Heidemann separating spatulas		F26
1101-3	Heidemann separating spatulas		F26
1102-1	Heidemann separating spatulas	Asa60	F27
1102T-1	Heidemann separating spatulas · Titanium nitride coating on the tips	Asa60	F27
1102-2	Heidemann separating spatulas	Asa60	F27
1102T-2	Heidemann separating spatulas · Titanium nitride coating on the tips	Asa60	F27
1102-3	Heidemann separating spatulas	Asa60	F27
1102T-3	Heidemann separating spatulas · Titanium nitride coating on the tips	Asa60	F27
1200-1	Filling instruments - amalgam	Asa60	F29
1200T-1	Filling instruments - amalgam · Titanium nitride coating	Asa60	F28
1200-2	Filling instruments - amalgam	Asa60	F29
1200T-2	Filling instruments - amalgam · Titanium nitride coating	Asa60	F28
1200-3	Filling instruments - amalgam	Asa60	F29
1200T-3	Filling instruments - amalgam · Titanium nitride coating	Asa60	F28
1200-4	Filling instruments - amalgam	Asa60	F29
1200-5	Filling instruments - amalgam	Asa60	F29
1201-1	Filling instruments - amalgam	Asa60	F29
1201-1L	Filling instruments - amalgam · Asa Com 9/9B	Asa60	F29, F51
1201-2	Filling instruments - amalgam	Asa60	F29
1201-2L	Filling instruments - amalgam · Asa Com 10/10B	Asa60	F29, F51
1201-3	Filling instruments - amalgam	Asa60	F29
1201-3L	Filling instruments - amalgam	Asa60	F29
1202-1	Filling instruments - amalgam	Asa60	F30
1202-1L	Filling instruments - amalgam	Asa60	F30
1202T-1	Filling instruments - amalgam · Titanium nitride coating	Asa60	F28
1202-2	Filling instruments - amalgam	Asa60	F30
1202-2L	Filling instruments - amalgam	Asa60	F30
1202T-2	Filling instruments - amalgam · Titanium nitride coating	Asa60	F28
1202-3	Filling instruments - amalgam	Asa60	F30
1202-3L	Filling instruments - amalgam	Asa60	F30
1202-4	Filling instruments - amalgam	Asa60	F30

CODE	DESCRIPTION	HANDLE	PAGE
1202-4L	Filling instruments - amalgam	Asa60	F30
1203-1	Filling instruments - amalgam · Asa Com 3/3B	Asa60	F30, F50
1203-2	Filling instruments - amalgam	Asa60	F30
1203-3	Filling instruments - amalgam · Asa Com 4/4B	Asa60	F30, F50
1204-1	Filling instruments - Burnishers · Westcott	Asa60	F34
1204T-1	Filling instruments - amalgam · Titanium nitride coating · Westcott	Asa60	F28
1204-2	Filling instruments - Burnishers · Westcott	Asa60	F34
1205-1	Filling instruments - amalgam · Ward	Asa60	F31
1205-2	Filling instruments - amalgam · Ward	Asa60	F31
1206-1	Filling instruments - plastic	Asa60	F36
1206-2	Filling instruments - plastic	Asa60	F36
1207-1	Filling instruments - plastic	Asa60	F36
1207-2	Filling instruments - plastic	Asa60	F36
1208-1	Filling instruments - plastic	Asa60	F36
1208T-1	Filling instruments - plastic · Titanium nitride coating	Asa60	F35
1208-2	Filling instruments - plastic	Asa60	F36
1208T-2	Filling instruments - plastic · Titanium nitride coating	Asa60	F35
1208-3	Filling instruments - plastic	Asa60	F36
1208T-3	Filling instruments - plastic · Titanium nitride coating	Asa60	F35
1209-1	Filling instruments - plastic	Asa60	F36
1209-2	Filling instruments - plastic	Asa60	F36
1209T-2	Filling instruments - plastic · Titanium nitride coating	Asa60	F35
1209-3	Filling instruments - plastic	Asa60	F36
1210-1	Composite instruments · Asa Com 14/14B	Asa60	F37, F52
1210-2	Filling instruments - plastic	Asa60	F37
1210T-2	Filling instruments - plastic · Titanium nitride coating	Asa60	F35
1210-3	Filling instruments - plastic · Asa Com 15/15B	Asa60	F37, F52
1211-0T	Filling instruments - amalgam · Tanner	Asa60	F31
1211-1T	Filling instruments - amalgam · Tanner	Asa60	F31
1211-2T	Filling instruments - amalgam · Tanner	Asa60	F31
1211-3T	Filling instruments - amalgam · Tanner	Asa60	F31
1212-01	Filling instruments - amalgam · Marquette	Asa60	F31
1213-H1	Filling instruments - amalgam · Hollenback	Asa60	F31
1213-H2	Filling instruments - amalgam · Hollenback	Asa60	F31
1213-H3	Filling instruments - amalgam · Asa Com 12/12B · Hollenback	Asa60	F31, F51
1213-H4	Filling instruments - amalgam · Hollenback	Asa60	F31
1214-2	Filling instruments - Burnishers · Ladmore	Asa60	F34
1214-3	Filling instruments - Burnishers · Ladmore	Asa60	F34
1214-A	Filling instruments - Burnishers	Asa60	F34
1215-18	Filling instruments - Burnishers · Ball	Asa60	F34
1215-27S	Filling instruments - Burnishers · Ball	Asa60	F34
1215-29	Filling instruments - Burnishers · Ball	Asa60	F34
1215-W3	Filling instruments - Burnishers	Asa60	F34
1216-1	Filling instruments - plastic · Woodson	Asa60	F37
1216-2	Filling instruments - plastic · Woodson	Asa60	F37
1216-3	Filling instruments - plastic · Woodson	Asa60	F37
1217-11	Filling instruments - plastic	Asa60	F37
1218-6	Filling instruments - plastic	Asa60	F37
1219-179	Filling instruments - plastic · Asa Com 5/5B	Asa60	F37, F50
1220-B2	Filling instruments - Burnishers · Asa Com 8/8B · New York University	Asa60	F34, F51
1221-31	Filling instruments - Burnishers	Asa60	F34
1300	Placement instruments	Asa35	F41
1301	Placement instruments	Asa60	F41
1302	Placement instruments	Asa60	F41
1303	Medication instruments · Orban Loop	Ottagonali	F41
1310-1	Instruments for retractor wire	Asa60	F40
1310-2	Instruments for retractor wire	Asa60	F40
1350-1	Ligature Instruments · band seating and removing instrument		I35
1350-2	Ligature Instruments · band seating and removing instrument		I35
1351-1	Ligature Instruments · band seating and removing instrument		I35
1352-1	Elastic instruments		I35
1355-1	Gauze packers · ligature and archwire tucker · Luniatcsek	Ottagonali	F41, I36
1355-2	Gauze packers · ligature and archwire tucker · Luniatcsek	Ottagonali	F41, I36
1400-1	Filling instruments - amalgam · Markley	Asa60	F32
1400-2	Filling instruments - amalgam · Markley	Asa60	F32

CODE	DESCRIPTION	HANDLE	PAGE
1400-3	Filling instruments - amalgam · Markley	Asa60	F32
1400-4	Filling instruments - amalgam · Markley	Asa60	F32
1400-5	Filling instruments - amalgam · Markley	Asa60	F32
1400-6	Filling instruments - amalgam · Markley	Asa60	F32
1401-0	Filling instruments - amalgam · Foc	Asa60	F33
1401-1	Filling instruments - amalgam · Asa Com 11/11B · Foc	Asa60	F33, F51
1401-2	Filling instruments - amalgam · Foc	Asa60	F33
1401-0S	Filling instruments - amalgam · Foc	Asa60	F33
1401-1S	Filling instruments - amalgam · Foc	Asa60	F33
1401-2S	Filling instruments - amalgam · Foc	Asa60	F33
1500-02	Amalgam/wax carvers · Hollenback	Asa60	F38, L13
1500-3	Amalgam/wax carvers · Hollenback	Asa60	F38, L13
1500-3S	Amalgam/wax carvers · Hollenback	Asa60	F38, L13
1501-1	Amalgam/wax carvers · Ward	Asa60	F38, L13
1501-1S	Amalgam/wax carvers · Ward	Asa60	F38, L13
1501-2	Amalgam/wax carvers · Ward	Asa60	F38, L13
1502-1	Amalgam/wax carvers · Frahm	Asa60	F39, L13
1503-2	Amalgam/wax carvers · USC	Asa60	F39, L13
1504-1	Modeling instruments · interproximal	Asa60	F39
1504-2	Modeling instruments · interproximal Off-angle · Asa Com 6/6B	Asa60	F39, F50
1505-3	Modeling instruments	Asa60	F39
1505-A	Modeling instruments	Asa60	F39
1506-104	Modeling instruments	Asa60	F39
1507-8	Modeling instruments · Wiland	Asa60	F39
1600-1	Modeling instruments · cleoid-discoid	Asa60	F40
1600-2	Modeling instruments · cleoid-discoid	Asa60	F40
1600-3	Modeling instruments · cleoid-discoid	Asa60	F40
1600-4	Modeling instruments · cleoid-discoid	Asa60	F40
1601-1	Cavity preparation instruments - margin trimmers · distal · Black/26	Asa60	F21
1601-2	Cavity preparation instruments - margin trimmers · mesial · Black/27	Asa60	F21
1601-3	Cavity preparation instruments - margin trimmers · distal · Black/28	Asa60	F21
1601-4	Cavity preparation instruments - margin trimmers · mesial · Black/29	Asa60	F21
1602-1	Cavity preparation instruments - margin trimmers · distal · Black/77-78	Asa60	F21
1602-2	Cavity preparation instruments - margin trimmers · mesial · Black/79-80	Asa60	F21
1603-1	Cavity preparation instruments - hatchets · Black/53-54	Asa60	F22
1603-2	Cavity preparation instruments - hatchets · Black/51-52	Asa60	F22
1604-02	Cavity preparation instruments - chisels · Wedelstaedt	Asa60	F22
1604-04	Cavity preparation instruments - chisels · Wedelstaedt	Asa60	F22
1604-06	Cavity preparation instruments - chisels · Wedelstaedt	Asa60	F22
1700-0	Excavators - spoons	Asa60	F16
1700-1	Excavators - oval spoons	Asa60	F16
1700-2	Excavators - spoons	Asa60	F16
1700-3	Excavators - spoons	Asa60	F16
1700-4	Excavators - spoons	Asa60	F16
1701-1	Excavators - spoons	Asa60	F16
1701-2	Excavators - spoons	Asa60	F16
1702-6	Excavators - spoons	Asa60	F17
1703-14	Excavators - spoons	Asa60	F17
1704-17	Excavators - spoons	Asa60	F17
1704-17W	Excavators - oval spoons	Asa60	F18
1705-18	Excavators - spoons	Asa60	F17
1705-18W	Excavators - oval spoons	Asa60	F18
1706-19	Excavators - spoons	Asa60	F17
1706-19W	Excavators - oval spoons	Asa60	F18
1707-39	Excavators - spoons	Asa60	F17
1709-31L	Root canal Excavators	Asa60	B15, F17
1709-32L	Root canal Excavators	Asa60	B15, F17
1709-33L	Root canal Excavators	Asa60	B15, F17
1710-5	Excavators · SS. White	Asa60	F19
1710-14	Excavators · SS. White	Asa60	F19
1710-17	Excavators · SS. White	Asa60	F19
1710-18	Excavators · SS. White	Asa60	F19
1710-19	Excavators · SS. White	Asa60	F19
1710-20	Excavators · SS. White	Asa60	F19
1711-1	Excavators · Darby-Perry	Asa60	F20

CODE	DESCRIPTION	HANDLE	PAGE
1711-2	Excavators · Darby-Perry	Asa60	F20
1711-11	Excavators · Darby-Perry	Asa60	F20
1711-12	Excavators · Darby-Perry	Asa60	F20
1711-21	Excavators · Darby-Perry	Asa60	F20
1711-22	Excavators · Darby-Perry	Asa60	F20
1711-31	Excavators · Darby-Perry	Asa60	F20
1711-32	Excavators · Darby-Perry	Asa60	F20
1711-41	Excavators · Darby-Perry	Asa60	F20
1711-42	Excavators · Darby-Perry	Asa60	F20
1711-243	Excavators · ASH	Asa60	F18
1711-G2	Excavators · ASH	Asa60	F18
1800-1	Bone chisels and gouges · Ochsenein		H27
1800-2	Bone chisels and gouges · Ochsenein		H27
1801-1	Chisels · TG	Asa60	H26
1801-2	Chisels · TG	Asa60	H26
1801-D	Chisels · TG	Asa60	H26
1802-3	Chisels · Ochsenein	Asa60	H26
1802-4	Chisels · Ochsenein	Asa60	H26
1803-1	Gingivectomy knives · Kirkland	Asa60	H24
1803-2	Gingivectomy knives · Kirkland	Asa60	H24
1803-D	Gingivectomy knives · Kirkland	Asa60	H24
1804-1	Gingivectomy knives · Orban	Asa60	H24
1804-2	Gingivectomy knives · Orban	Asa60	H24
1804-D	Gingivectomy knives · Orban	Asa60	H24
1805-02	Curettes and Scalers · Langer	Asa60	H5
1805-04	Curettes and Scalers · Langer	Asa60	H5
1806-02	Curettes and Scalers	Asa60	H4
1806-2RL	Curettes and Scalers · Columbia	Asa60	H4
1806-4RL	Curettes and Scalers · Columbia	Asa60	H4
1806-14	Curettes and Scalers · Columbia	Asa60	H4
1806-412	Curettes and Scalers · Columbia	Asa60	H4
1806-414	Curettes and Scalers · Columbia	Asa60	H4
1807-02	Gracey curettes	Asa60	H11
1807-02AF	Gracey curettes - AF	Asa60	H12
1807-02MF	Gracey curettes - MF	Asa60	H13
1807-04	Gracey curettes	Asa60	H11
1807-04AF	Gracey curettes - AF	Asa60	H12
1807-04MF	Gracey curettes - MF	Asa60	H13
1807-06	Gracey curettes	Asa60	H11
1807-06AF	Gracey curettes - AF	Asa60	H12
1807-06MF	Gracey curettes - MF	Asa60	H13
1807-08	Gracey curettes	Asa60	H11
1807-08AF	Gracey curettes - AF	Asa60	H12
1807-08MF	Gracey curettes - MF	Asa60	H13
1807-10	Gracey curettes	Asa60	H11
1807-11MD	Gracey curettes · mesial-distal	Asa60	H11
1807-12	Gracey curettes	Asa60	H11
1807-12AF	Gracey curettes - AF	Asa60	H12
1807-12MF	Gracey curettes - MF	Asa60	H13
1807-13MD	Gracey curettes · mesial-distal	Asa60	H11
1807-14	Gracey curettes	Asa60	H11
1807-14AF	Gracey curettes - AF	Asa60	H12
1807-14MF	Gracey curettes - MF	Asa60	H13
1807-16	Gracey curettes	Asa60	H11
1807-16AF	Gracey curettes - AF	Asa60	H12
1807-16MF	Gracey curettes - MF	Asa60	H13
1807-18	Gracey curettes	Asa60	H11
1808-1	Curettes and Scalers · De Marco	Asa60	H5
1808-2	Curettes and Scalers · De Marco	Asa60	H5
1809-1	Curettes and Scalers · Goldman-Fox	Asa60	H6
1809-2	Curettes and Scalers · Goldman-Fox	Asa60	H6
1809-3	Curettes and Scalers · Goldman-Fox	Asa60	H6
1809-4	Curettes and Scalers · Goldman-Fox	Asa60	H6
1809-5	Curettes and Scalers · Goldman-Fox	Asa60	H6
1809-6	Curettes and Scalers · Goldman-Fox	Asa60	H6

CODE	DESCRIPTION	HANDLE	PAGE
1809-21	Curettes and Scalers · Goldman-Fox	Asa60	H6
1810-07	Files · Hirschfeld	Asa60	H22
1811-37	Chisels · back-action · Rhodes	Asa60	H26
1812-02S	Files · Sugarman	Asa60	H22
1812-04S	Files · Sugarman	Asa60	H22
1813-10	Files · Schluger	Asa60	H22
1815-7	Gingivectomy knives · Goldman-Fox	Asa60	H25
1815-8	Gingivectomy knives · Goldman-Fox	Asa60	H25
1815-9	Gingivectomy knives · Goldman-Fox	Asa60	H25
1815-11	Gingivectomy knives · Goldman-Fox	Asa60	H25
1816-04	Gingivectomy knives · Buck	Asa60	H25
1816-06	Gingivectomy knives · Buck	Asa60	H24
1817-02	Gingivectomy knives · Sanders	Asa60	H25
1817-05	Gingivectomy knives · Sanders	Asa60	H25
1818-20	Gingivectomy knives · USC Towner (University of South California)	Asa60	H25
1819-CK3	Gingivectomy knives · Crane-Kaplan	Asa60	H25
1820-Z	Curettes and Scalers · Zerfing-Chisel	Asa60	H4
1821-02	Curettes and Scalers · Barnhart	Asa60	H5
1821-06	Curettes and Scalers · Barnhart	Asa60	H5
1822-ME1	Curettes and Scalers	Asa60	H5
1823-R04	Curettes and Scalers · Rule	Asa60	H5
1824-14	Curettes and Scalers · anterior · Indiana University	Asa60	H5
1824-18	Curettes and Scalers · posterior · Indiana University	Asa60	H5
1825-12	Curettes and Scalers · Mc Call	Asa60	H7
1825-14	Curettes and Scalers · Mc Call	Asa60	H7
1825-20	Curettes and Scalers · Mc Call	Asa60	H7
1825-12A	Curettes and Scalers · Mc Call	Asa60	H7
1825-14S	Curettes and Scalers · Mc Call	Asa60	H7
1825-18S	Curettes and Scalers · Mc Call	Asa60	H7
1826-T03	Curettes and Scalers · Taylor	Asa60	H8
1827-204	Curettes and Scalers	Asa60	H8
1827-204S	Curettes and Scalers	Asa60	H8
1829-CK6	Curettes and Scalers · Crane-Kaplan	Asa60	H8
1829-CK6S	Curettes and Scalers · Mini Crane-Kaplan	Asa60	H8
1830-YG08	Curettes and Scalers · Younger-Good	Asa60	H8
1831-32	Curettes and Scalers · Jacqueline	Asa60	H9
1831-33	Curettes and Scalers · Jacqueline	Asa60	H9
1831-35	Curettes and Scalers · Jacqueline	Asa60	H9
1831-38	Curettes and Scalers · Jacqueline	Asa60	H9
1832-1	Bone chisels and gouges · Gardner		H27
1832-2	Bone chisels and gouges · Gardner		H27
1832-5	Bone chisels and gouges · Gardner		H27
1832-5R	Bone chisels and gouges · Gardner		H27
1832-6	Bone chisels and gouges · Gardner		H27
1833-1W	Bone chisels and gouges · Wakefield		H27
1833-2W	Bone chisels and gouges · Wakefield		H27
1834-3	Bone chisels and gouges · Buckley		H27
1835-3	Bone chisels and gouges · Partsch		H28
1835-4	Bone chisels and gouges · Partsch		H28
1835-5	Bone chisels and gouges · Partsch		H28
1835-6	Bone chisels and gouges · Partsch		H28
1836-3	Bone chisels and gouges · Partsch		H28
1836-4	Bone chisels and gouges · Partsch		H28
1836-5	Bone chisels and gouges · Partsch		H28
1836-6	Bone chisels and gouges · Partsch		H28
1837-3	Bone chisels and gouges · Partsch		H28
1837-4	Bone chisels and gouges · Partsch		H28
1837-5	Bone chisels and gouges · Partsch		H28
1837-6	Bone chisels and gouges · Partsch		H28
1838-3	Bone chisels and gouges · Partsch		H28
1838-4	Bone chisels and gouges · Partsch		H28
1838-5	Bone chisels and gouges · Partsch		H28
1838-6	Bone chisels and gouges · Partsch		H28
1839-1	Freer single cut chisels · Freer		E16
1839-2	Freer single cut chisels · Freer		E16

CODE	DESCRIPTION	HANDLE	PAGE
1839-3	Freer single cut chisels · Freer		E16
1840-1	Graduated chisels · straight		E17
1840-2	Graduated chisels · curved		E17
1840-3	Graduated chisels · straight		E17
1840-4	Graduated chisels · curved		E17
1844-3	Mucotomes · straight		E26
1844-3C	Mucotomes · curved		E26
1844-4	Mucotomes · straight		E26
1844-4C	Mucotomes · curved		E26
1844-5	Mucotomes · straight		E26
1844-5C	Mucotomes · curved		E26
1844-6	Mucotomes · straight		E26
1844-6C	Mucotomes · curved		E26
1846	Bone mill		E27
1849-1	Periosteals and Elevators · Partsch	Asa60	E24, H17
1855-22	Periosteals and Elevators · retractor · Seldin		E25, H18
1855-23	Periosteals and Elevators · retractor · Seldin		E25, G16, H18
1856-1	Periosteals and Elevators · Williger		E25, H19
1856-2	Periosteals and Elevators · Williger		E25, H19
1857-1	Periosteals and Elevators · Williger		E25, H19
1857-2	Periosteals and Elevators · Williger		E25, H19
1858-1	Periosteals and Elevators · König		E25, H18
1870-1	Mouth gags · Molt		C33
1870-2	Mouth gags · Molt		C33
1871-1	Mouth gags · Roser-Koenig		C33
1871-2	Mouth gags · Roser-Koenig		C33
1880	Surgical mallets · Partsch		E16, H29
1881	Surgical mallets · Mead		E16, H29
1881-R	Inserts for mallets · Teflon		H29
1882	Surgical mallets · Mead		H29
1884	Surgical mallets · Vickers		H29
1885	Surgical mallets · Herbert		H29
1890-1F	Grinding stones · fine grain		H32
1890-1M	Grinding stones · medium grain		H32
1890-2	Grinding stones		H32
1890-3	Grinding stones		H32
1890-4	Grinding stones		H32
1890-5	Grinding stones		H32
1890-6	Grinding stones		H33
1890-7	Grinding stones		H33
1891-1	Grinding stones		H33
1900-1L	Scalers · left	Asa60	H15
1900-1R	Scalers · right	Asa60	H15
1900-2L	Scalers · left	Asa60	H15
1900-2R	Scalers · right	Asa60	H15
1900-M23	Scalers · universal scaler	Asa60	H14
1901-1	Scalers	Asa60	H15
1902-1	Scalers · Towner Jacqueline	Asa60	H14
1902-2	Scalers · Towner Jacqueline	Asa60	H14
1903	Scalers · Towner	Asa60	H14
1904-H5	Scalers	Asa60	H14
1904-H6	Scalers	Asa60	H14
1905-02	Scalers	Asa60	H14
1906-33	Scalers	Asa60	H15
1909-H5	Scalers	Asa60	H15
1909-H6	Scalers	Asa60	H15
1909-H7	Scalers · Hygienist	Asa60	H15
2000-1	Bone curettes · Hemingway	Asa60	C45, E21, H20
2000-2	Bone curettes · Hemingway	Asa60	C45, E21, H20
2000-3	Bone curettes · Hemingway	Asa60	C45, E21, H20
2000-4	Bone curettes · Hemingway	Asa60	H20
2001-85	Bone curettes · Lucas	Asa60	H20
2001-86	Bone curettes · Lucas	Asa60	H20
2001-87	Bone curettes · Lucas	Asa60	H20
2001-88	Bone curettes · Lucas	Asa60	H20

CODE	DESCRIPTION	HANDLE	PAGE
2002-6	Mirrors (mouth) parallelometer		B19
2003-1	Bone files · Polokoff	Asa Light MV	H23
2004-33	Bone files	Asa Light MV	H23
2005-45	Bone files · Miller	Asa Light MV	H23
2005-64	Bone files · Miller	Asa Light MV	E21, H23
2006-10	Bone files	Asa Light MV	E21, H23
2007-12A	Bone files	Asa Light MV	H23
2007-12CA	Bone files	Asa Light MV	H23
2008-12	Bone files	Asa Light MV	H23
2013-2	Bone curettes · U.S.A. pattern		H21
2013-2L	Bone curettes · U.S.A. pattern		H21
2013-2R	Bone curettes · U.S.A. pattern		H21
2014-3	Bone curettes		C45, E21
2015-0	Bone curettes · Williger		H21
2015-00	Bone curettes · Williger		H21
2015-1	Bone curettes · Williger		H21
2016-0	Bone curettes		H21
2016-00	Bone curettes		H21
2016-1	Bone curettes		H21
2100-CS	Cone-socket Mouth Mirrors - Handles		B20
2101-CS	Cone-socket Mouth Mirrors - Handles		B20
2102-CS	Cone-socket Mouth Mirrors - Handles		B20
2104-B	Simple stem Mouth Mirrors - Handles		B19
2104-C	Simple stem Mouth Mirrors - Handles		B19
2104-G	Simple stem Mouth Mirrors - Handles		B19
2104-R	Simple stem Mouth Mirrors - Handles		B19
2104-V	Simple stem Mouth Mirrors - Handles		B19
2200E-4	Simple stem Mouth Mirrors		B18
2200E-5	Simple stem Mouth Mirrors		B18
2200E-6	Simple stem Mouth Mirrors		B18
2201E-4	Simple stem Mouth Mirrors		B18
2201E-5	Simple stem Mouth Mirrors		B18
2210E-4	Cone-socket Mouth Mirrors		B20
2210E-5	Cone-socket Mouth Mirrors		B20
2211E-4	Cone-socket Mouth Mirrors - Handles		B20
2211E-5	Cone-socket Mouth Mirrors - Handles		B20
2220E-4	Simple stem Mouth Mirrors · Rhodium		B18
2220E-5	Simple stem Mouth Mirrors · Rhodium		B18
2221-4	Simple stem Mouth Mirrors · Titanium		B18
2221-5	Simple stem Mouth Mirrors · Titanium		B18
2230-5	Simple stem Mouth Mirrors		B18
2231-5CS	Cone-socket Mouth Mirrors		B20
2240-1	Simple stem mouth mirrors · Ø 3 mm · plane, micro		B19, G11, G15
2240-2	Simple stem mouth mirrors · Ø 5 mm · plane, micro		B19
2240-3	Simple stem mouth mirrors · 7x2 mm · plane, micro		B19
2240-4	Simple stem mouth mirrors · 9x3 mm · plane, micro		B19
2241-5	Simple stem mouth mirrors · 6x3 mm · plane, micro		B19, G16
2250-1	Photographic Mirrors · occlusal surfaces		B17
2250-2	Photographic Mirrors · occlusal surfaces		B17
2250-3	Photographic Mirrors · buccal surfaces		B17
2250-4	Photographic Mirrors · lingual surfaces		B17
2250-5	Photographic Mirrors · lingual surfaces		B17
2300-D	Crown removers		F42
2300-S	Crown removers		F42
2301	Tips for crown removers		F42
2302	Tips for crown removers		F42
2305-D	Crown removers		F42
2306	Tips for crown removers		F42
2307	Tips for crown removers		F42
2308	Tips for crown removers		F42
2320	Crown removers and spreaders		F43
2331-1	Copper ring removing pliers · straight · Furrer		F45
2331-2	Copper ring removing pliers · curved · Furrer		F45
2340-0	Crown spreaders		F43
2340-1	Crown spreaders		F43

CODE	DESCRIPTION	HANDLE	PAGE
2340-2	Crown spreaders		F43
2340-3	Crown spreaders		F43
2400	Direct bond bracket holders		I34
2401	Direct bond bracket holders		I34
2402	Direct bond bracket holders		I34
2410	Band pusher · Mershon		I34
2411	Band setter		I34
2412	Band pusher · used in all heat sterilizers		I34
2450	Separating pliers · for elastics and separators		I35
2500-1	Crown pliers · Böhm		F45, L29
2500-2	Crown pliers · Böhm		F45, L29
2550-1	Calipers · for wax · Iwanson		F44, L30
2550-2	Calipers · for metal · Iwanson		F44, L30
2555	Calipers · Boley		F44, L30
2556-1	Calipers · aluminum, graded in millimeters and inches		L30
2556-2	Calipers · aluminum, graded in millimeters and inches · Townley		L30
2556-3	Calipers · Jameson		L30
2556-4	Calipers		E33
2557-1	Calipers		L30
2601	Lip retractors · Columbia		C34
2602-1	Lip retractors · Sternberg		C34, E11
2602-2	Lip retractors · Sternberg		C34
2602-3	Lip retractors · Sternberg		C34
2604	Cheek retractor · University of Minnesota		C34, E12
2605	Tongue depressors		C34
2606	Tongue depressors		C34
2607	Tongue depressors · Buchwald		C34
2608	Tongue depressors · Brünings		C34
2609-2	Lip retractors · Orringer medium		C34, E11
2611-1	Retractors · blunt		C35
2611-2	Retractors · blunt		C35
2613-1	Retractors · sharp · Senn-Miller		C35
2613-2	Retractors · blunt · Senn-Miller		C35
2615-1	Retractors · Kilner		C35
2616-1	Retractors · Farabeuf		C35
2617-2	Retractors · left, sharp · Williger		C35
2617-3	Retractors · right, sharp · Williger		C35
2618-1	Retractors · straight, blunt · Williger		C35
2618-2	Retractors · left, blunt · Williger		C35
2620-1	Retractors · Middeldorpf		C37, E12
2620-2	Retractors · Middeldorpf		C37
2620-3	Retractors · Middeldorpf		C37
2621-1	Retractors · Langenbeck		C36
2621-2	Retractors · Langenbeck		C36
2621-3	Retractors · Langenbeck		C36
2621-4	Retractors · Langenbeck		C36
2621-5	Retractors · Langenbeck		C36
2622-1	Retractors · Langenbeck		C36
2622-2	Retractors · Langenbeck		C36
2622-3	Retractors · Langenbeck		C36
2622-4	Retractors · Langenbeck		C36
2622-5	Retractors · Langenbeck		C36
2623-1	Retractors · Kocher		C36
2623-2	Retractors · Kocher		C36
2624-1	Retractors · Kocher		C36
2624-2	Retractors · Kocher		C36
2625-1	Ramus retractors for nasal spine		C36, E12
2626-1	Ramus retractors for nasal spine		C36, E12
2627	Retractors		C37, E11
2628-1	Labial retractors		C37, E10
2628-2	Vestibular retractor		E10
2650-02	Antrum probes · Bowman		C37
2650-08	Antrum probes · Bowman		C37
2651-1	Antrum probes		C37
2651-2	Antrum probes		C37

CODE	DESCRIPTION	HANDLE	PAGE
2700-G	Stainless steel instrument trays · for 7 instruments		J6
2700-L	Stainless steel instrument trays · non-perforated base		J6
2700-U	Stainless steel instrument trays · non-perforated lid		J6
2702-L	Stainless steel instrument trays · perforated base		J6
2702-U	Stainless steel instrument trays · perforated lid		J6
2720-L	Stainless steel instrument trays · non-perforated base		J5
2720-U	Stainless steel instrument trays · non-perforated lid		J4, J5
2721-L	Stainless steel instrument trays · perforated base		J4, J4
2721-U	Stainless steel instrument trays · perforated lid		J4
2723-L	Stainless steel instrument trays · non-perforated base		J6
2723-U	Stainless steel instrument trays · non-perforated lid		J6
2724-L	Stainless steel instrument trays · non-perforated base		J7
2724-U	Stainless steel instrument trays · non-perforated lid		J7
2730-1	Stainless steel instrument trays · for 16 instruments		J5
2730-2	Stainless steel instrument trays · for 23 instruments		J5
2730-3	Dental dam instrument kit · insert frame		F13
2730-4	Stainless steel instrument trays · for 8 instruments		J7
2730-5	Stainless steel instrument trays · for 4 instruments		J7
2731-1	Dental dam instrument kit		F14
2737-1	Stainless steel trays		J14
2737-2	Stainless steel trays		J14
2737-3	Stainless steel trays		J14
2737-4	Stainless steel trays		J14
2750-1	Drinking cup dispensers		A16
2750-2	Drinking cup dispensers		A16
2751-1	Dispensers (cotton pellet) in stainless steel		J21
2770-1	Stainless steel instrument cassettes · large · for 20 instruments · Blue		J2
2770-1A	Stainless steel instrument cassettes · large · for 20 instruments · Orange		J2
2770-1MX	Locking tray for 20 instruments (lilac, yellow, green)		G13, J2
2770-1R	Stainless steel instrument cassettes · large · for 20 instruments · Red		J2
2770-1V	Stainless steel instrument cassettes · large · for 20 instruments · Green		J2
2770-2	Stainless steel instrument cassettes · large · for 15 instruments · Blue		J2
2770-2A	Stainless steel instrument cassettes · large · for 15 instruments · Orange		J2
2770-2R	Stainless steel instrument cassettes · large · for 15 instruments · Red		J2
2770-2V	Stainless steel instrument cassettes · large · for 15 instruments · Green		J2
2770-3	Stainless steel instrument cassettes · large · for 10 instruments · Blue		J2
2770-3A	Stainless steel instrument cassettes · large · for 10 instruments · Orange		J2
2770-3R	Stainless steel instrument cassettes · large · for 10 instruments · Red		J2
2770-3V	Stainless steel instrument cassettes · large · for 10 instruments · Green		J2
2770-G	Silicone instrument holder · 10 slots · Blue		J3
2770-GA	Silicone instrument holder · 10 slots · Orange		J3
2770-GR	Silicone instrument holder · 10 slots · Red		J3
2770-GV	Silicone instrument holder · 10 slots · Green		J3
2771-1	Stainless steel instrument cassettes · medium · for 10 instruments · Blue		J2
2771-1A	Stainless steel instrument cassettes · medium · for 10 instruments · Orange		J2
2771-1L	Locking tray for 10 instruments (lilac)		G9, J2
2771-1R	Stainless steel instrument cassettes · medium · for 10 instruments · Red		J2
2771-1V	Stainless steel instrument cassettes · medium · for 10 instruments · Green		J2
2771-2	Stainless steel instrument cassettes · medium · for 5 instruments · Blue		J2
2771-2A	Stainless steel instrument cassettes · medium · for 5 instruments · Orange		J2
2771-2R	Stainless steel instrument cassettes · medium · for 5 instruments · Red		J2
2771-2V	Stainless steel instrument cassettes · medium · for 5 instruments · Green		J2
2771-G	Silicone instrument holder · 5 slots · Blue		J3
2771-GA	Silicone instrument holder · 5 slots · Orange		J3
2771-GR	Silicone instrument holder · 5 slots · Red		J3
2771-GV	Silicone instrument holder · 5 slots · Green		J3
2772-1	Stainless steel instrument cassettes · mini · for 5 instruments · Blue		J3
2772-1A	Stainless steel instrument cassettes · mini · for 5 instruments · Orange		J3
2772-1R	Stainless steel instrument cassettes · mini · for 5 instruments · Red		J3
2772-1V	Stainless steel instrument cassettes · mini · for 5 instruments · Green		J3
2772-G	Silicone insert frame · for 10 instruments · Blue		J3
2772-GA	Silicone insert frame · for 10 instruments · Orange		J3
2772-GR	Silicone insert frame · for 10 instruments · Red		J3
2772-GV	Silicone insert frame · for 10 instruments · Green		J3
2773-G	Silicone insert frame · for 5 instruments · Blue		J3

CODE	DESCRIPTION	HANDLE	PAGE
2880-L2	Perforated aluminum impression trays for implantology		K41
2880-L3	Perforated aluminum impression trays for implantology		K41
2880-L4	Perforated aluminum impression trays for implantology		K41
2880-L5	Perforated aluminum impression trays for implantology		K41
2880-L6	Perforated aluminum impression trays for implantology		K41
2880-U1	Perforated aluminum impression trays for implantology		K41
2880-U2	Perforated aluminum impression trays for implantology		K41
2880-U3	Perforated aluminum impression trays for implantology		K41
2880-U4	Perforated aluminum impression trays for implantology		K41
2880-U5	Perforated aluminum impression trays for implantology		K41
2880-U6	Perforated aluminum impression trays for implantology		K41
2900E-AT13	Multi-color saliva ejectors		A4
2900E-AT15	Multi-color saliva ejectors		A4
2900E-ATS15	Multi-color saliva ejectors		A5
2900E-BBS15	Multi-color saliva ejectors		A5
2900E-BT13	Multi-color saliva ejectors		A4
2900E-BT15	Multi-color saliva ejectors		A4
2900E-GT13	Multi-color saliva ejectors		A4
2900E-GT15	Multi-color saliva ejectors		A4
2900E-LT13	Multi-color saliva ejectors		A4
2900E-LT15	Multi-color saliva ejectors		A4
2900E-OT13	Multi-color saliva ejectors		A5
2900E-OT15	Multi-color saliva ejectors		A5
2900E-RT13	Multi-color saliva ejectors		A5
2900E-RT15	Multi-color saliva ejectors		A5
2900E-TCS15	Multi-color saliva ejectors		A5
2900E-TT13	Multi-color saliva ejectors		A4
2900E-TT15	Multi-color saliva ejectors		A4
2900E-TTS15	Multi-color saliva ejectors		A5
2900E-VT13	Multi-color saliva ejectors		A4
2900E-VT15	Multi-color saliva ejectors		A4
2900E-VTS15	Multi-color saliva ejectors		A5
2900E-ZT13	Multi-color saliva ejectors		A5
2900E-ZT15	Multi-color saliva ejectors		A5
2901E-AT13	Multi-color saliva ejectors		A4
2901E-AT15	Multi-color saliva ejectors		A4
2901E-TT13	Multi-color saliva ejectors		A4
2901E-TT15	Multi-color saliva ejectors		A4
2901E-VT13	Multi-color saliva ejectors		A4
2901E-VT15	Multi-color saliva ejectors		A4
2902-L	Surgical stainless steel saliva ejectors		C44
2902-M	Surgical stainless steel saliva ejectors		C44
2902-S	Surgical stainless steel saliva ejectors		C44
2903E-BA155	Soft-tip saliva ejectors - Total-Comfort		A3
2903E-BAS155	Soft-tip saliva ejectors - Total-Comfort		A3
2903E-BT155	Soft-tip saliva ejectors - Total-Comfort		A3
2903E-BTS155	Soft-tip saliva ejectors - Total-Comfort		A3
2903E-TA155	Soft-tip saliva ejectors - Total-Comfort		A3
2903E-TAS155	Soft-tip saliva ejectors - Total-Comfort		A3
2903E-TT155	Soft-tip saliva ejectors - Total-Comfort		A3
2903E-TTS155	Soft-tip saliva ejectors - Total-Comfort		A3
2904-6	Surgical stainless steel saliva ejectors - Frazier		C44
2904-8	Surgical stainless steel saliva ejectors - Frazier		C44
2904-10	Surgical stainless steel saliva ejectors - Frazier		C44
2904-12	Surgical stainless steel saliva ejectors - Frazier		C44
2908E-AT13	Mint-scented saliva ejectors - AsaFresh		A2
2908E-AT15	Mint-scented saliva ejectors - AsaFresh		A2, A6
2908E-BBS15	Mint-scented saliva ejectors - AsaFresh		A2
2908E-TCS15	Mint-scented saliva ejectors - AsaFresh		A2
2908E-TT13	Mint-scented saliva ejectors - AsaFresh		A2
2908E-TT15	Mint-scented saliva ejectors - AsaFresh		A2
2908E-TTS15	Mint-scented saliva ejectors - AsaFresh		A2
2908E-VT13	Mint-scented saliva ejectors - AsaFresh		A2
2908E-VT15	Mint-scented saliva ejectors - AsaFresh		A2
2908E-VTS15	Mint-scented saliva ejectors - AsaFresh		A2

CODE	DESCRIPTION	HANDLE	PAGE
3030	Clamp forceps - Ivory lightweight		F12
3031	Clamp forceps - Brewer		F12
3032	Punching forceps - Ainsworth		F11
3033	Punching forceps - Ivory		F11
3034	Clamp forceps - Stoke		F12
3040-1	Dental dam instruments		F12
3041-1	Dental dam instruments		F12
3045	Dental dam instruments - latex dam vacuum packed 36 pcs/pack		F11
3050-60	Dental dam clamps - wingless clamp		F8
3051-26	Dental dam clamps - wingless clamp		F9
3051-29	Dental dam clamps - winged clamp		F8
3051-51	Dental dam clamps - wingless clamp		F9
3051-202	Dental dam clamps - winged clamp		F10
3051-205	Dental dam clamps - wingless clamp		F10
3051-210	Dental dam clamps - winged clamp		F6
3051-212	Dental dam clamps - winged clamp		F6
3052-0	Dental dam clamps - winged clamp		F7
3052-00	Dental dam clamps - winged clamp		F6
3052-W0	Dental dam clamps - wingless clamp		F7
3052-1	Dental dam clamps - winged clamp		F7
3052-W1	Dental dam clamps - wingless clamp		F7
3052-2	Dental dam clamps - winged clamp		F8
3052-2A	Dental dam clamps - winged clamp		F7
3052-2AT	Dental dam clamps - winged, serrated clamp		F7
3052-2T	Dental dam clamps - winged, serrated clamp		F8
3052-W2	Dental dam clamps - wingless clamp		F8
3052-W2A	Dental dam clamps - wingless clamp		F7
3052-3	Dental dam clamps - winged clamp		F8
3052-W3	Dental dam clamps - wingless clamp		F8
3052-4	Dental dam clamps - winged clamp		F10
3052-W4	Dental dam clamps - wingless clamp		F10
3052-7	Dental dam clamps - winged clamp		F9
3052-W7	Dental dam clamps - wingless clamp		F9
3052-8	Dental dam clamps - winged clamp		F10
3052-8A	Dental dam clamps - winged clamp		F9
3052-W8	Dental dam clamps - wingless clamp		F10
3052-W8A	Dental dam clamps - wingless clamp		F9
3052-9	Dental dam clamps - winged clamp		F6
3052-9T	Dental dam clamps - winged clamp		F6
3052-12A	Dental dam clamps - winged, serrated clamp		F10
3052-13A	Dental dam clamps - winged, serrated clamp		F10
3052-14	Dental dam clamps - winged clamp		F9
3052-14A	Dental dam clamps - winged clamp		F10
3052-14T	Dental dam clamps - winged, serrated clamp		F9
3052-W14	Dental dam clamps - wingless clamp		F9
3052-W14A	Dental dam clamps - wingless clamp		F10
3052-1T	Dental dam clamps - winged, serrated clamp		F7
3070-5	Matrix retainers - Ivory		F48
3070-6	Matrix retainers - Ivory		F48
3070-7	Matrix retainers - Ivory		F48
3071	Matrix retainers - Ivory		F48
3072	Matrix retainers - Didner		F48
3073-1	Matrix retainers - Tofflemire universal		F48
3073-2	Matrix retainers - Tofflemire Junior		F48
3073-3	Matrix retainers - Tofflemire Senior		F48
3081-1	Matrices - Tofflemire		F49
3081-2	Matrices - Tofflemire		F49
3081-3	Matrices - Tofflemire		F49
3081	Matrices - Tofflemire		F49
3082-5	Bands for matrix retainers		F49
3082-6	Bands for matrix retainers		F49
3082-7	Bands for matrix retainers		F49
3101-1	Accessories - spare wick		J21
3101	Accessories - alcohol burner		J21
3201	Napkins - AsaRainbow - patient bib chain		A7

CODE	DESCRIPTION	HANDLE	PAGE
3251E-C/6	Bibs - Tear off rolls 50x60 cm (80 bibs)		A15
3251E-D/6	Bibs - Tear off rolls 50x60 cm (80 bibs)		A15
3251E-O/6	Bibs - Tear off rolls 50x60 cm (80 bibs)		A15
3251E-V/6	Bibs - Tear off rolls 50x60 cm (80 bibs)		A15
3252E-C/6	Bibs - Tear off rolls 50x80 cm (60 bibs)		A15
3252E-D/6	Bibs - Tear off rolls 50x80 cm (60 bibs)		A15
3252E-O/6	Bibs - Tear off rolls 50x80 cm (60 bibs)		A15
3252E-V/6	Bibs - Tear off rolls 50x80 cm (60 bibs)		A15
3400E-55	Sterilization rolls		A12
3400E-75	Sterilization rolls		A12
3400E-100	Sterilization rolls		A12
3400E-150	Sterilization rolls		A12
3400E-200	Sterilization rolls		A12
3400E-250	Sterilization rolls		A12
3400-300	Sterilization rolls		A12
3403-75	Sterilization pouches		A14
3403-90	Sterilization pouches		A14
3403-140	Sterilization pouches		A14
3450E-B	Surgical masks		A13
3450E-C	Surgical masks		A13
3450E-N	Surgical masks		A13
3450E-R	Surgical masks		A13
3450E-V	Surgical masks		A13
3510-B	Napkins - AsaRainbow		A6
3510-BX	Napkins - AsaRainbow		A6
3510-C	Napkins - AsaRainbow		A6
3510-D	Napkins - AsaRainbow		A6
3510-F	Napkins - AsaRainbow		A6
3510-G	Napkins - AsaRainbow		A6
3510-GR	Napkins - AsaRainbow		A6
3510-L	Napkins - AsaRainbow		A6
3510-LI	Napkins - AsaRainbow		A7
3510-N	Napkins - AsaRainbow		A7
3510-O	Napkins - AsaRainbow		A7
3510-P	Napkins - AsaRainbow		A7
3510-PE	Napkins - AsaRainbow		A7
3510-V	Napkins - AsaRainbow		A7
3511-B	Napkins - AsaRainbow		A6
3511-BX	Napkins - AsaRainbow		A6
3511-C	Napkins - AsaRainbow		A6
3511-D	Napkins - AsaRainbow		A6
3511-F	Napkins - AsaRainbow		A6
3511-G	Napkins - AsaRainbow		A6
3511-GR	Napkins - AsaRainbow		A6
3511-L	Napkins - AsaRainbow		A6
3511-LI	Napkins - AsaRainbow		A7
3511-N	Napkins - AsaRainbow		A7
3511-O	Napkins - AsaRainbow		A7
3511-P	Napkins - AsaRainbow		A7
3511-PE	Napkins - AsaRainbow		A7
3511-V	Napkins - AsaRainbow		A7
3520-1	Cotton rolls		A11
3520-2	Cotton rolls		A11
3520-3	Cotton rolls		A11
3600E	Synthetic instant ice		A18
3700-B	Dappen dishes		A9
3700-C	Dappen dishes		A9
3700-G	Dappen dishes		A9
3700-MX	Dappen dishes		A8
3700-N	Dappen dishes		A9
3700-R	Dappen dishes		A9
3710	Plastic syringes		A17
3818-B	Cups		A16
5000-1	Articulators - spare parts - mounting plate		L6
5000-1M	Articulators - spare parts - magnetic mounting plate - complete		L7

CODE	DESCRIPTION	HANDLE	PAGE
5000-4N	Articulators - spare parts - incisal table (10°)		L8
5000-5	Articulators - spare parts - metallic locking knob		L8
5000-7	Articulators - spare parts - adjusting screw - side shift		L8
5000-8	Articulators - spare parts - incisal pin		L8
5000-12	Articulators - spare parts - side shift spring		L8
5000-13	Articulators - spare parts - side shift cylinder		L8
5000-18	Articulators - spare parts - M5 screw - incisal table		L8
5000-24	Articulators - spare parts - rubber nubs		L8
5000-25	Articulators - spare parts - cast fastening washers		L7
5000-26	Articulators - spare parts - magnet		L7
5000-30	Articulators - spare parts - magnet holder		L7
5001	Articulators - occlusor		L6
5002	Articulators - average values		L6
5010-10	Articulators - spare parts - bearing rod		L8
5011-4	Articulators - spare parts - incisal table (0°)		L8
5011-6	Articulators - spare parts - locking knob		L8
5011-11	Articulators - spare parts - rubber cap		L8
5011-16	Articulators - spare parts - inclined contrast table		L8
5011-18	Articulators - spare parts - hinge rod washer		L8
5011-19	Articulators - spare parts - hinge rod spring		L8
5011-23	Articulators - spare parts - adjusting screw locknut		L8
5020	Easy Bow - complete set		L10
5021	Easy Bow - face bow		L10
5022	Easy Bow - fork holder		L10
5023-1	Easy Bow - fork		L10
5023-2	Easy Bow - fork		L10
5023-3	Easy Bow - fork		L10
5024	Easy Bow - transfer table		L10
5030	Articulators - average values		L4
5030-2	Articulators - spare parts - occlusal table		L8
5030-3	Articulators - spare parts - incisal guide rod		L8
5030-6	Articulators - spare parts - locking knob for spacer		L8
5030-9	Articulators - spare parts - condylar guidance rod		L8
5030-10	Articulators - spare parts - bearing rod		L8
5030-29	Articulators - spare parts - spacer		L7
5032	Articulators - average values		L5
5032-16	Articulators - spare parts - inclined contrast table		L8
5032-17	Articulators - spare parts - hinge rod		L8
5032-21	Articulators - spare parts - back rod		L8
5032-22	Articulators - spare parts - adjusting screw		L8
5032-23	Articulators - spare parts - adjusting screw locknut		L8
5033	Articulators - spare parts - fast caliper		L8
5050	Articulators - average values		L2
5050-2	Articulators - spare parts - support for occlusal table and mounting jig		L8
5050-3	Articulators - spare parts - incisal guide rod		L8
5050-4	Articulators - spare parts - knurled knob for occlusal table and mounting jig		L8
5050-6	Articulators - spare parts - locking knob		L8
5050-8	Articulators - spare parts - incisal pin		L8
5050-17	Articulators - spare parts - hinge rod		L8
5050-20	Articulators - spare parts - back rod support		L8
5050-21	Articulators - spare parts - back rod		L8
5050-24	Articulators - spare parts - rubber nubs		L8
5050PLUS	Articulators - average values		L3
5051	Articulators - spare parts - occlusal table		L8
5052	Articulators - spare parts - mounting jig		L8
5053	Articulators - spare parts - magnetic rod kit		L8
5053-1	Articulators - spare parts - magnetic rod		L8
5053-2	Articulators - spare parts - rod ferrule		L8
5053-3	Articulators - spare parts - table for magnetic rod		L8
5054	Articulators - spare parts - occlusal table assembly (5050-4 + 5051 + 5050-2)		L8
5100-1	Amalgam/wax carvers - graded handle in mm - Hylin		L14
5100	Amalgam/wax carvers - Hylin		L14
5101	Amalgam/wax carvers - Hylin-Le Cron		L14
5102	Amalgam/wax carvers - Hylin		L14
5103	Amalgam/wax carvers - Hylin		L14

CODE	DESCRIPTION	HANDLE	PAGE
5104	Amalgam/wax carvers		L14
5105	Amalgam/wax carvers · Le Cron		L15
5106	Amalgam/wax carvers · Le Cron		L15
5107	Amalgam/wax carvers · Le Cron		L15
5108	Amalgam/wax carvers · Le Cron		L15
5109	Amalgam/wax carvers · Zahle		L15
5110	Amalgam/wax carvers · Zahle		L15
5111	Amalgam/wax carvers · Zahle		L16
5112-1	Amalgam/wax carvers · P.K. Thomas	Asa60	L17
5112-1AL	Amalgam/wax carvers · P.K. Thomas	Alu80	L17
5112-2	Amalgam/wax carvers · P.K. Thomas	Asa60	L17
5112-2AL	Amalgam/wax carvers · P.K. Thomas	Alu80	L17
5112-3	Amalgam/wax carvers · Asa Com 1/1B · P.K. Thomas	Asa60	F50, L17
5112-3AL	Amalgam/wax carvers · P.K. Thomas	Alu80	L17
5112-4	Amalgam/wax carvers · Asa Com 13/13B · P.K. Thomas	Asa60	F52, L17
5112-4AL	Amalgam/wax carvers · P.K. Thomas	Alu80	L17
5112-5	Amalgam/wax carvers · P.K. Thomas	Asa60	L17
5112-5AL	Amalgam/wax carvers · P.K. Thomas	Alu80	L17
5113	Amalgam/wax carvers · Gritman		L16
5114	Amalgam/wax carvers · Beale		L16
5114-1	Periosteals and Elevators · Beale	Ottagonal	E22, H16
5115	Amalgam/wax carvers · Roach		L16
5116	Amalgam/wax carvers · Vehe		L16
5150	Ceramic sculpting instruments		L21
5150-1	Ceramic sculpting instruments	Alu80	L21
5150-2	Ceramic sculpting instruments	Alu80	L21
5150-3	Ceramic sculpting instruments	Alu80	L21
5151	Ceramic sculpting instruments		L21
5151-1	Ceramic sculpting instruments · Greenstein	Alu80	L21
5151-2	Ceramic sculpting instruments · Greenstein	Alu80	L21
5151-3	Ceramic sculpting instruments · Greenstein	Alu80	L21
5153-1	Composite instruments · Asa Com 7/7B	Alu80	F51
5155-1	Ceramic sculpting instruments		L21
5155-2	Ceramic sculpting instruments		L21
5155-3	Ceramic sculpting instruments		L21
5156-1	Ceramic sculpting instruments		L21
5156-2	Ceramic sculpting instruments		L21
5156-3	Ceramic sculpting instruments		L21
5160-1	Ceramic sculpting instruments (tips)		L18
5160-2	Ceramic sculpting instruments (tips)		L18
5160-3	Ceramic sculpting instruments (tips)		L18
5200-1	Wax knives · Fahnenstock		L22
5200-2	Wax knives · Fahnenstock		L22
5201-1	Wax knives · Lessmann		L22
5201-2	Wax knives · Lessmann		L22
5202-1	Wax knives		L22
5202-2	Wax knives		L22
5300-1	Plaster knives		L23
5300-2	Plaster knives · Gritman		L23
5300-3	Plaster knives		L23
5300-4	Plaster knives		L23
5400-1	Rigid spatulas for plaster, alginate and elastomers		L24
5400-2	Rigid spatulas for plaster, alginate and elastomers		L24
5400-3	Rigid spatulas for plaster, alginate and elastomers		L24
5400-4	Flexible spatulas for plaster, alginate and elastomers		L25
5400-5	Flexible spatulas for plaster, alginate and elastomers		L25
5400-6	Flexible spatulas for plaster, alginate and elastomers		L25
5400-7	Flexible spatulas for plaster, alginate and elastomers		L25
5400-8	Rigid spatulas for plaster, alginate and elastomers		L24
5400-9	Rigid spatulas for plaster, alginate and elastomers		L24
5401-B	Spatulas for plaster and alginate		L26
5401-C	Spatulas for plaster and alginate		L26
5401-F	Spatulas for plaster and alginate		L26
5401-G	Spatulas for plaster and alginate		L26
5401-R	Spatulas for plaster and alginate		L26

CODE	DESCRIPTION	HANDLE	PAGE
5401-V	Spatulas for plaster and alginate		L26
5500-10	Mixing bowls for plaster and alginate		L26
5500-12	Mixing bowls for plaster and alginate		L26
5500-14	Mixing bowls for plaster and alginate		L26
5500-16	Mixing bowls for plaster and alginate		L26
5501-10	Mixing bowls for plaster and alginate		L26
5501-12	Mixing bowls for plaster and alginate		L26
5501-14	Mixing bowls for plaster and alginate		L26
5501-16	Mixing bowls for plaster and alginate		L26
5600-1	Crown scissors · straight, one blade serrated		F47, L28
5600-2	Crown scissors · curved, one blade serrated		F47, L28
5601-1	Crown scissors · straight		F47, L28
5601-2	Crown scissors · curved		F47, L28
5700	Universal scissors · straight, one blade serrated · universal		F47, L28
5700TC	Universal scissors · TC universal		F47
5800	Wire forming pliers · Nance		I12
5801-1	Wire forming pliers · Delphin universal		I10
5801-3	Wire forming pliers · universal pliers		I10
5802	Wire forming pliers · Waldsachs		I11
5806	Wire forming pliers		I12
5809-1	Wire forming pliers · Tweed		I12
5809-2	Wire forming pliers · Tweed		I13
5809-3	Wire forming pliers · Tweed		I15
5812	Wire forming pliers · Reynolds		I16
5818	Wire forming pliers		I16
5819	Utility pliers · Weingart		I29
5821-1	Wire forming pliers · De La Rosa		I18
5821-2	Wire forming pliers · non-grooved pliers · De La Rosa		I18
5824-1	Utility pliers		I31
5825	Utility pliers		I32
5826-1	Utility pliers		I30
5826-2	Utility pliers		I30
5828-1	Utility pliers		I30
5828-2	Utility pliers		I31
5832-1TC	Cutters · multi-use wire cutter		I7
5832	Cutters · multi-use wire cutter		I7
5833-1TC	Cutters · micro-miniature wire cutter		I8
5833	Cutters · micro-miniature wire cutter		I8
5836-1TC	Cutters · distal end cutter		I9
5836	Cutters · distal end cutter		I9
5837	Cutters · micro distal end cutter		I9
5838	Wire forming pliers · with cutter · Angle		I19
5860-1	Wire forming pliers · Mc Kellops		I18
5861	Wire forming pliers · Johnson		I20
5862	Wire forming pliers · loop pliers · Nance		I15
5863	Wire forming pliers · Young		I14
5864	Wire forming pliers · flat bending pliers		I18
5865	Wire forming pliers · short rounded jaws pliers		I19
5866	Wire forming pliers · Angle		I19
5867-1	Wire forming pliers · Adams		I20
5867-2	Wire forming pliers · Adams		I20
5868	Wire forming pliers · long rounded jaws pliers		I19
5869-1	Wire forming pliers · mini · Aderer		I21
5869-2	Wire forming pliers · standard · Aderer		I21
5870	Wire forming pliers · Tweed		I14
5871	Wire forming pliers · ligh bird beak pliers		I24
5872-1	Wire forming pliers · Tweed (Angle)		I15
5874-1	Wire forming pliers · universal pliers · How		I23
5874-2	Wire forming pliers · How		I23
5875-1	Wire forming pliers · flat bending pliers		I24
5875-2	Wire forming pliers · flat knurled bending pliers		I24
5876-1	Wire forming pliers · bending pliers		I24
5876-2	Wire forming pliers · knurled bending pliers		I24
5880-1	Cutters · wire cutter <= 0.9 mm		I8
5880-2	Cutters · wire cutter <= 1.5 mm		I8

CODE	DESCRIPTION	HANDLE	PAGE
5880-3TC	Cutters · wire cutter <= 1.2 mm		I9
5900	Plaster cutting pliers · Asa Special Inox		L31
6000	Mallets		L31
6001	Mallets		L31
6002	Mallets		L31
6200	Fret saw		L33
6201-1	Fret saw blades · for plaster		L33
6201-2	Fret saw blades · for metal		L33
6300	Saw for models		L33
6301-1	Fret saw blades · for models		L33
6301-2	Fret saw blades · for models		L33
6301-3	Fret saw blades · for models		L33
6400-1	Laboratory tweezers		L19
6400-2	Laboratory tweezers		L19
6600-2	Crucible tongs		L32
6600-4	Crucible tongs		L32
6600-5	Crucible tongs		L32
6900E-A	Ortho/prosthesis boxes · Blue		I37, L27
6900E-B	Ortho/prosthesis boxes · White		I37, L27
6900E-C	Ortho/prosthesis boxes · Light blue		I37, L27
6900E-G	Ortho/prosthesis boxes		I37, L27
6900E-R	Ortho/prosthesis boxes		I37, L27
6900E-V	Ortho/prosthesis boxes		I37, L27
7000-6	Brushes for ceramics		L20
7000-8	Brushes for ceramics		L20
7001-0	Brushes for ceramics		L20
7001-00	Brushes for ceramics		L20
7001-1	Brushes for ceramics		L20
7001-3	Brushes for ceramics		L20
7002-4	Brushes for ceramics		L20
7002-6	Brushes for ceramics		L20
7002-8	Brushes for ceramics		L20
8000	Orthodontic Lab Set		L34
8001	Grinding stones · Asa Oil		H33
8002	Protective lubricant for instruments · Steril Oil		D73, J14
8010	Protective lubricant for instruments · Silicone		D73, J14
8020	AsaClean · PH neutral solution to facilitate removal of alginate		K44
8801-1	Wire forming pliers · universal pliers · Delphin		I10
8801-2	Wire forming pliers · universal pliers		I10
8802	Wire forming pliers · Waldsachs		I11
8803	Wire forming pliers · optical pliers		I26
8804-1	Wire forming pliers · Tweed		I14, I28
8804-2	Wire forming pliers · Tweed		I13, I28
8804-2P	Wire forming pliers		I13
8804-3P	Wire forming pliers		I13
8805	Wire forming pliers · Reynolds		I16
8806	Wire forming pliers · hollow chop pliers		I26
8807-1	Wire forming pliers · mini arch bending pliers		I17, I28
8807-2	Wire forming pliers · arch bending pliers		I17, I28
8807-3	Wire forming pliers		I16, I28
8808-1	Utility pliers · Weingart		I29
8808-2	Utility pliers · Weingart		I29
8809	Utility pliers		I31
8810	Utility pliers		I32
8811-1	Utility pliers		I30
8811-1P	Utility pliers		I30, I31
8811-2	Utility pliers		I31
8812-1TC	Cutters · multi-use wire cutter		I7
8812-2TC	Cutters · hard wire cutter 15°		I4
8813-1TC	Cutters · universal distal-end-cutter no hold		I4
8814-1TC	Cutters · universal distal-end cutter		I5
8815	Wire forming pliers · Johnson		I20
8816	Wire forming pliers · precision pliers · Nance		I11, I28
8817	Wire forming pliers · Young		I14
8818	Wire forming pliers · universal bird beak pliers		I22, I28

CODE	DESCRIPTION	HANDLE	PAGE
8819	Wire forming pliers · Adams		I20, I28
8820-1	Wire forming pliers · mini · Aderer		I21, I28
8820-2	Wire forming pliers · standard · Aderer		I21, I28
8821	Wire forming pliers · bird beak pliers		I22, I28
8822-1	Wire forming pliers · universal pliers · How		I23
8822-2	Wire forming pliers · How		I23
8823	Wire forming pliers · Schwarz		I25, I28
8824-1TC	Cutters · mini ligatures cutter		I6
8825	Wire forming pliers · hammerhead NiTi pliers		I25, I28
8826-1TC	Cutters · distal end flush cutter		I5
8827-1TC	Cutters · micro ligatures cutter 15°		I6
8828-1TC	Utility pliers		I33
8829	Wire forming pliers · Jarabak		I27
8830	Wire forming pliers · V-stop		I27, I28
8831	Utility pliers		I32
8831-1P	Utility pliers		I32
8832	Bracket placement marker		I36
9002-1	Insert for 6 extractive forceps		D73
9002-2	Inserts with elastic bands for 10 instruments		D73
9002-3	Inserts with slots for 16 instruments		D73
9002	Case for instruments and pliers		D73
AL2720-LA	Anodized aluminum color-coded instrument trays · Silver		J8
AL2720-LC	Anodized aluminum color-coded instrument trays · Light blue		J8
AL2720-LO	Anodized aluminum color-coded instrument trays · Gold		J8
AL2720-LR	Anodized aluminum color-coded instrument trays · Red		J8
AL2720-LV	Anodized aluminum color-coded instrument trays · Green		J8
AL2720-UA	Anodized aluminum color-coded instrument trays · Silver		J8
AL2721-LA	Anodized aluminum color-coded instrument trays · perforated · Silver		J9
AL2721-LC	Anodized aluminum color-coded instrument trays · perforated · Light blue		J9
AL2721-LO	Anodized aluminum color-coded instrument trays · perforated · Gold		J9
AL2721-LR	Anodized aluminum color-coded instrument trays · perforated · Red		J9
AL2721-LV	Anodized aluminum color-coded instrument trays · perforated · Green		J9
AL2721-UA	Anodized aluminum color-coded instrument trays · perforated · Silver		J9
AL2722-LA	Anodized aluminum color-coded instrument trays · Silver		J10
AL2722-LC	Anodized aluminum color-coded instrument trays · Light blue		J10
AL2722-LO	Anodized aluminum color-coded instrument trays · Gold		J10
AL2722-LR	Anodized aluminum color-coded instrument trays · Red		J10
AL2722-LV	Anodized aluminum color-coded instrument trays · Green		J10
AL2722-UA	Anodized aluminum color-coded instrument trays · Silver		J10
AL2723-LA	Anodized aluminum color-coded instrument trays · Silver		J11
AL2723-LC	Anodized aluminum color-coded instrument trays · Light blue		J11
AL2723-LO	Anodized aluminum color-coded instrument trays · Gold		J11
AL2723-LR	Anodized aluminum color-coded instrument trays · Red		J11
AL2723-LV	Anodized aluminum color-coded instrument trays · Green		J11
AL2723-UA	Anodized aluminum color-coded instrument trays · Silver		J11
AL2724-1	Anodized aluminum containers for instrument trays		J15
AL2724-2	Anodized aluminum containers for instrument trays		J15
AL2724-3	Anodized aluminum containers for instrument trays		J15
AL2724-4	Anodized aluminum containers for instrument trays		J15
AL2725	Endodontic articles		J18
AL2727-1	Plastic trays		A10
AL2727-1Z	Plastic trays		A10
AL2727-2	Plastic trays		A10
AL2727-2Z	Plastic trays		A10
AL2730-1	Aluminum insert frames · for 11 instruments		J12
AL2730-2	Aluminum insert frames · for 17 instruments		J12
AL2730-3	Aluminum insert frames · for 10 instruments		J12
AL2730-4	Aluminum insert frames · for 11 instruments		J12
AL2731-1	Aluminum insert frames · for 8 instruments		J12
AL2731-2	Aluminum insert frames · for 4 instruments		J12
AL2735	Mixing trays		A17
AL2736	Plastic mixing spatulas		A17
AL2738-1	Plastic trays		A10
AL2738-2	Plastic trays		A10
AL2739-1	Aluminum instrument tray rack · 6 compartments		J15

CODE	DESCRIPTION	HANDLE	PAGE
AL2739-2	Aluminum instrument tray rack · 6 compartments		J15
AL2740-1	Endodontic boxes		J16
AL2740-2	Endodontic boxes		J16
AL2740-3	Endodontic boxes		J16
AL2740-4	Endodontic boxes		J16
AL2740-5	Endodontic boxes		J16
AL2740-R	Endodontic boxes		J16, J17
AL2741-1	Endodontic boxes		J16
AL2741-2	Endodontic boxes		J16
AL2742-1	Endodontic boxes		J17
AL2742-2	Endodontic boxes		J17
AL2742-3	Endodontic boxes		J17
AL2742-4	Endodontic boxes		J17
AL2742-5	Endodontic boxes		J17
AL2742-6	Endodontic boxes		J17
AL2742-7	Endodontic boxes		J17
AL2743	Endodontic boxes		J17
AL2744	Endodontic boxes		J17
AL2745-1A	Endodontic articles		J18
AL2745-2C	Endodontic articles		J18
AL2746-1	Endodontic articles		J18
AL2746-2	Endodontic articles		J18
AL2747-1A	Endodontic articles		J18
AL2760-1	Bur holders · with rim, 24 FG holes		J19
AL2760-2	Bur holders · aluminum, suitable for steam sterilizing - with rim, 24 CA holes		E34, J19
AL2760-3	Bur holders · aluminum, suitable for steam sterilizing - with rim, 24 FG/CA holes		E34, J19
AL2760-U	Bur holders · lid		J19
AL2761-1	Bur holders · with rim, 36 FG holes		J19
AL2761-2	Bur holders · with rim, 36 CA holes		J19
AL2761-3	Bur holders · with rim, 36 FG/CA holes		J19
AL2761-U	Bur holders · lid		E34, J19
AL2762-1	Bur holders · aluminum, suitable for steam sterilizing - 48 FG holes		J19
AL2762-2	Bur holders · aluminum, suitable for steam sterilizing - 48 CA holes		E34, J19
AL2762-3	Bur holders · aluminum, suitable for steam sterilizing - 48 FG/CA holes		J19
AL2763-1	Bur holders · with 7 bur holders, with lid		J19
AL2763-2	Bur holders · with 2 bur holders		J19
AL2764-A	Accessories · anodized aluminum waste container		J20
AL2764-C	Accessories · anodized aluminum waste container		J20
AL2764-O	Accessories · anodized aluminum waste container		J20
AL2764-R	Accessories · anodized aluminum waste container		J20
AL2764-V	Accessories · anodized aluminum waste container		J20
AL2765-A	Accessories · anodized aluminum cotton dispensers		J20
AL2765-C	Accessories · anodized aluminum cotton dispensers		J20
AL2765-O	Accessories · anodized aluminum cotton dispensers		J20
AL2765-R	Accessories · anodized aluminum cotton dispensers		J20
AL2765-V	Accessories · anodized aluminum cotton dispensers		J20
AL2766	Accessories · plastic box for used needles		A17, J21
AL2767-1	Accessories · waste containers		A18, J20
AL2767-2	Accessories · aluminum base for waste container		A18, J20
LV1807-02	Gracey curettes	Leonardo Light	H11
LV1807-02AF	Gracey curettes - AF	Leonardo Light	H12
LV1807-02MF	Gracey curettes - MF	Leonardo Light	H13
LV1807-04	Gracey curettes	Leonardo Light	H11
LV1807-04AF	Gracey curettes - AF	Leonardo Light	H12
LV1807-04MF	Gracey curettes - MF	Leonardo Light	H13
LV1807-06	Gracey curettes	Leonardo Light	H11
LV1807-06AF	Gracey curettes - AF	Leonardo Light	H12
LV1807-06MF	Gracey curettes - MF	Leonardo Light	H13
LV1807-08	Gracey curettes	Leonardo Light	H11
LV1807-08AF	Gracey curettes - AF	Leonardo Light	H12
LV1807-08MF	Gracey curettes - MF	Leonardo Light	H13
LV1807-10	Gracey curettes	Leonardo Light	H11
LV1807-11MD	Gracey curettes	Leonardo Light	H11
LV1807-12	Gracey curettes	Leonardo Light	H11
LV1807-12AF	Gracey curettes - AF	Leonardo Light	H12

CODE	DESCRIPTION	HANDLE	PAGE
LV1807-12MF	Gracey curettes - MF	Leonardo Light	H13
LV1807-13MD	Gracey curettes	Leonardo Light	H11
LV1807-14	Gracey curettes	Leonardo Light	H11
LV1807-14AF	Gracey curettes - AF	Leonardo Light	H12
LV1807-14MF	Gracey curettes - MF	Leonardo Light	H13
LV1807-16	Gracey curettes	Leonardo Light	H11
LV1807-16AF	Gracey curettes - AF	Leonardo Light	H12
LV1807-16MF	Gracey curettes - MF	Leonardo Light	H13
LV1807-18	Gracey curettes	Leonardo Light	H11
LV1807-02SF	Gracey curettes · Sharpen Free	Leonardo Light	H11
LV1807-04SF	Gracey curettes · Sharpen Free	Leonardo Light	H11
LV1807-06SF	Gracey curettes · Sharpen Free	Leonardo Light	H11
LV1807-08SF	Gracey curettes · Sharpen Free	Leonardo Light	H11
LV1807-10SF	Gracey curettes · Sharpen Free	Leonardo Light	H11
LV1807-12SF	Gracey curettes · Sharpen Free	Leonardo Light	H11
LV1807-14SF	Gracey curettes · Sharpen Free	Leonardo Light	H11
LV1807-16SF	Gracey curettes · Sharpen Free	Leonardo Light	H11
LV1807-18SF	Gracey curettes · Sharpen Free	Leonardo Light	H11
LV1826-T03	Curettes and Scalers · Taylor	Leonardo Light	H8
LV1827-204S	Curettes and Scalers	Leonardo Light	H8
LV1829-CK6	Curettes and Scalers · Crane-Kaplan	Leonardo Light	H8
MB026-1	Stainless steel compass		K20
ML0700-3R	Single-ended Explorers · Rhein	Leonardo ML	B6
ML0700-6	Single-ended Explorers	Leonardo ML	B6
ML0700-8	Single-ended Explorers	Leonardo ML	B6
ML0700-9	Single-ended Explorers	Leonardo ML	B6
ML0700-17	Single-ended Explorers	Leonardo ML	B6
ML0700-23	Single-ended Explorers	Leonardo ML	B6
ML0702-OMS	Periodontal pocket Probes · Novatech	Leonardo ML	H3
ML0703-14	Periodontal pocket Probes · Williams	Leonardo ML	H3
ML0704-6D2	Double-ended explorers	Leonardo ML	B9
ML0704-6D9	Double-ended explorers	Leonardo ML	B8
ML0704-11/12AF	Double-ended explorers	Leonardo ML	B8
ML0704-23D1	Double-ended explorers	Leonardo ML	B8
ML0705-23W	Expres (combination explorers/probes) · Williams	Leonardo ML	B10
ML0708-2N	Double-ended explorers · Nabers	Leonardo ML	B11
ML0800-1	Root canal Spreaders	Leonardo ML	B12, G4
ML0800-2	Root canal Spreaders	Leonardo ML	B12, G4
ML0800-3	Root canal Spreaders	Leonardo ML	B12, G4
ML0802-1	Root canal Pluggers · Schilder	Leonardo ML	B14, G6
ML0802-2	Root canal Pluggers · Schilder	Leonardo ML	B14, G6
ML0802-3	Root canal Pluggers · Schilder	Leonardo ML	B14, G6
ML0802-4	Root canal Pluggers · Schilder	Leonardo ML	B14, G6
ML0802-5	Root canal Pluggers · Schilder	Leonardo ML	B14, G6
ML0802-6	Root canal Pluggers · Schilder	Leonardo ML	B14, G6
ML0802-7	Root canal Pluggers · Schilder	Leonardo ML	B14, G6
ML0802-8	Root canal Pluggers · Schilder	Leonardo ML	B14, G6
ML0802-9	Root canal Pluggers · Schilder	Leonardo ML	B14, G6
ML0802-10	Root canal Pluggers · Schilder	Leonardo ML	B14, G6
ML0803-1	Root canal Pluggers · Machtou	Leonardo ML	B13, G5
ML0803-2	Root canal Pluggers · Machtou	Leonardo ML	B13, G5
ML0803-3	Root canal Pluggers · Machtou	Leonardo ML	B13, G5
ML0803-4	Root canal Pluggers · Machtou	Leonardo ML	B13, G5
ML0804-1	Depth gauges		E32
ML0805-1	Apical - Plugger PIR1	Leonardo ML	G10, G14
ML1102-1	Heidemann separating spatulas	Leonardo ML	F27, G18
ML1222-1	Apical - Plugger PIR2	Leonardo ML	G10, G14
ML1222-2	Apical - Plugger PIR3	Leonardo ML	G10, G14
ML1401-0	Filling instruments - amalgam · Foc	Leonardo ML	F33
ML1401-0S	Filling instruments - amalgam · Foc	Leonardo ML	F33
ML1401-1	Filling instruments - amalgam · Foc	Leonardo ML	F33
ML1401-1S	Filling instruments - amalgam · Foc	Leonardo ML	F33
ML1401-2	Filling instruments - amalgam · Foc	Leonardo ML	F33
ML1401-2S	Filling instruments - amalgam · Foc	Leonardo ML	F33
ML1710-5	Excavators · SS. White	Leonardo ML	F19

CODE	DESCRIPTION	HANDLE	PAGE
ML1710-14	Excavators · SS. White	Leonardo ML	F19
ML1710-17	Excavators · SS. White	Leonardo ML	F19
ML1710-18	Excavators · SS. White	Leonardo ML	F19
ML1710-19	Excavators · SS. White	Leonardo ML	F19
ML1710-20	Excavators · SS. White	Leonardo ML	F19
ML1711-1	Excavators · Darby-Perry	Leonardo ML	F20
ML1711-2	Excavators · Darby-Perry	Leonardo ML	F20
ML1711-11	Excavators · Darby-Perry	Leonardo ML	F20
ML1711-12	Excavators · Darby-Perry	Leonardo ML	F20
ML1711-21	Excavators · Darby-Perry	Leonardo ML	F20
ML1711-22	Excavators · Darby-Perry	Leonardo ML	F20
ML1711-31	Excavators · Darby-Perry	Leonardo ML	F20
ML1711-32	Excavators · Darby-Perry	Leonardo ML	F20
ML1711-41	Excavators · Darby-Perry	Leonardo ML	F20
ML1711-42	Excavators · Darby-Perry	Leonardo ML	F20
ML1711-243	Excavators · ASH	Leonardo ML	F18
ML1711-G2	Excavators · ASH	Leonardo ML	F18
ML1803-D	Gingivectomy knives · Kirkland	Leonardo ML	H24
ML1804-D	Gingivectomy knives · Orban	Leonardo ML	H24
ML1806-2RL	Curettes and Scalers · Columbia	Leonardo ML	H4
ML1806-4RL	Curettes and Scalers · Columbia	Leonardo ML	H4
ML1806-14	Curettes and Scalers · Columbia	Leonardo ML	H4
ML1807-02	Gracey curettes	Leonardo ML	G17, H11
ML1807-02AF	Gracey curettes - AF	Leonardo ML	H12
ML1807-02MF	Gracey curettes - MF	Leonardo ML	H13
ML1807-04	Gracey curettes	Leonardo ML	H11
ML1807-04AF	Gracey curettes - AF	Leonardo ML	H12
ML1807-04MF	Gracey curettes - MF	Leonardo ML	H13
ML1807-06	Gracey curettes	Leonardo ML	H11
ML1807-06AF	Gracey curettes - AF	Leonardo ML	H12
ML1807-06MF	Gracey curettes - MF	Leonardo ML	H13
ML1807-08	Gracey curettes	Leonardo ML	H11
ML1807-08AF	Gracey curettes - AF	Leonardo ML	H12
ML1807-08MF	Gracey curettes - MF	Leonardo ML	H13
ML1807-10	Gracey curettes	Leonardo ML	H11
ML1807-11MD	Gracey curettes	Leonardo ML	H11
ML1807-12	Gracey curettes	Leonardo ML	H11
ML1807-12AF	Gracey curettes - AF	Leonardo ML	H12
ML1807-12MF	Gracey curettes - MF	Leonardo ML	H13
ML1807-13MD	Gracey curettes	Leonardo ML	H11
ML1807-14	Gracey curettes	Leonardo ML	G17, H11
ML1807-14AF	Gracey curettes - AF	Leonardo ML	H12
ML1807-14MF	Gracey curettes - MF	Leonardo ML	H13
ML1807-16	Gracey curettes	Leonardo ML	H11
ML1807-16AF	Gracey curettes - AF	Leonardo ML	H12
ML1807-16MF	Gracey curettes - MF	Leonardo ML	H13
ML1807-18	Gracey curettes	Leonardo ML	H11
ML1809-1	Curettes and Scalers · Goldman-Fox	Leonardo ML	H6
ML1809-2	Curettes and Scalers · Goldman-Fox	Leonardo ML	H6
ML1809-3	Curettes and Scalers · Goldman-Fox	Leonardo ML	H6
ML1809-4	Curettes and Scalers · Goldman-Fox	Leonardo ML	H6
ML1809-5	Curettes and Scalers · Goldman-Fox	Leonardo ML	H6
ML1809-21	Curettes and Scalers · Goldman-Fox	Leonardo ML	H6
ML1816-06	Gingivectomy knives · Buck	Leonardo ML	H24
ML1825-14S	Curettes and Scalers · Mc Call	Leonardo ML	H7
ML1826-T03	Curettes and Scalers · Taylor	Leonardo ML	H8
ML1827-204S	Curettes and Scalers	Leonardo ML	H8
ML1829-CK6	Curettes and Scalers · Crane-Kaplan	Leonardo ML	H8
ML1829-CK6S	Curettes and Scalers · Mini Crane-Kaplan	Leonardo ML	H8
ML1830-YG08	Curettes and Scalers · Younger-Good	Leonardo ML	H8
ML1845-1	Periotomes	Leonardo ML	D70, E29
ML1845-2	Periotomes	Leonardo ML	D70, E29
ML1845-3	Periotomes	Leonardo ML	D70, E29
ML1900-M23	Scalers · Universal Scaler	Leonardo ML	H14
ML1902-1	Scalers · Towner Jacquette	Leonardo ML	H14

CODE	DESCRIPTION	HANDLE	PAGE
ML1903	Scalers · Towner	Leonardo ML	H14
ML1906-1	Scalers · Jacquette	Leonardo ML	H15
ML1906-2	Scalers · Jacquette	Leonardo ML	H15
ML1906-3	Scalers · Jacquette	Leonardo ML	H15
ML2000-1	Bone curettes · Hemingway	Leonardo ML	C45, E21, H20
ML2000-2	Bone curettes · Hemingway	Leonardo ML	C45, E21, H20
ML2000-3	Bone curettes · Hemingway	Leonardo ML	C45, E21, H20
ML2000-4	Bone curettes · Hemingway	Leonardo ML	H20
ML2001-85	Bone curettes · Lucas	Leonardo ML	H20
ML2001-86	Bone curettes · Lucas	Leonardo ML	H20
ML2001-87	Bone curettes · Lucas	Leonardo ML	H20
ML2001-88	Bone curettes · Lucas	Leonardo ML	H20
ML2017-1	Apical - Bone curette FAR1	Leonardo ML	G11, G15
ML2017-2	Apical - Bone curette FAR2	Leonardo ML	G11, G15
ML2101	Simple stem Mouth Mirrors - Handles	Leonardo ML	B19, G11, G15, G16
MV0704-16D1	Double-ended explorers	Asa Light MV	B8
MV0704-16D2	Double-ended explorers	Asa Light MV	B8
MV0704-23D1	Double-ended explorers	Asa Light MV	B8
MV0704-23D2	Double-ended explorers	Asa Light MV	B8
MV0704-UT1	Double-ended explorers · Cattoni	Asa Light MV	B8
MV0705-3GF	Root canal Explorers · Goldman-Fox	Asa Light MV	B10
MV0705-16GF	Expros (combination explorers/probes) · Goldman-Fox	Asa Light MV	B10
MV0705-16W	Expros (combination explorers/probes) · Williams	Asa Light MV	B10
MV0705-17GF	Expros (combination explorers/probes) · Goldman-Fox	Asa Light MV	B10
MV0705-17UM	Expros (combination explorers/probes) · University of Michigan	Asa Light MV	B10
MV0705-17W	Expros (combination explorers/probes) · Williams	Asa Light MV	B10
MV0705-23GF	Expros (combination explorers/probes) · Goldman-Fox	Asa Light MV	B10
MV0705-23UM	Expros (combination explorers/probes) · University of Michigan	Asa Light MV	B10
MV0705-23W	Expros (combination explorers/probes) · Williams	Asa Light MV	B10
MV0706-2311	Expros (combination explorers/probes)	Asa Light MV	B10
MV0706-2312	Expros (combination explorers/probes)	Asa Light MV	B10
MV0707-GFW	Expros (combination explorers/probes) · Goldman-Fox Williams	Asa Light MV	B11
MV0708-1N	Double-ended explorers · Nabers	Asa Light MV	B11
MV0708-2N	Double-ended explorers · Nabers	Asa Light MV	B11
MV0709-2	Double-ended explorers	Asa Light MV	B8
MV0709-2A	Double-ended explorers	Asa Light MV	B8
MV0709-3	Double-ended explorers	Asa Light MV	B9
MV0710-6D1	Root canal Explorers	Asa Light MV	B9
MV0710-6D2	Root canal Explorers	Asa Light MV	B9
MV0710-6D3	Root canal Explorers	Asa Light MV	B9
MV1102-1	Heidemann separating spatulas	Asa Light MV	F27
MV1102-2	Heidemann separating spatulas	Asa Light MV	F27
MV1102-3	Heidemann separating spatulas	Asa Light MV	F27
MV1200-1	Filling instruments - amalgam	Asa Light MV	F29
MV1200-2	Filling instruments - amalgam	Asa Light MV	F29
MV1200-3	Filling instruments - amalgam	Asa Light MV	F29
MV1200-4	Filling instruments - amalgam	Asa Light MV	F29
MV1200-5	Filling instruments - amalgam	Asa Light MV	F29
MV1201-1	Filling instruments - amalgam	Asa Light MV	F29
MV1201-1L	Filling instruments - amalgam	Asa Light MV	F29
MV1201-2	Filling instruments - amalgam	Asa Light MV	F29
MV1201-2L	Filling instruments - amalgam	Asa Light MV	F29
MV1201-3	Filling instruments - amalgam	Asa Light MV	F29
MV1201-3L	Filling instruments - amalgam	Asa Light MV	F29
MV1202-1	Filling instruments - amalgam	Asa Light MV	F30
MV1202-1L	Filling instruments - amalgam	Asa Light MV	F30
MV1202-2	Filling instruments - amalgam	Asa Light MV	F30
MV1202-2L	Filling instruments - amalgam	Asa Light MV	F30
MV1202-3	Filling instruments - amalgam	Asa Light MV	F30
MV1202-3L	Filling instruments - amalgam	Asa Light MV	F30
MV1202-4	Filling instruments - amalgam	Asa Light MV	F30
MV1202-4L	Filling instruments - amalgam	Asa Light MV	F30
MV1203-1	Filling instruments - amalgam	Asa Light MV	F30
MV1203-2	Filling instruments - amalgam	Asa Light MV	F30
MV1203-3	Filling instruments - amalgam	Asa Light MV	F30

CODE	DESCRIPTION	HANDLE	PAGE
MV1204-1	Filling instruments - Burnishers - Westcott	Asa Light MV	F34
MV1204-2	Filling instruments - Burnishers - Westcott	Asa Light MV	F34
MV1205-1	Filling instruments - amalgam - Ward	Asa Light MV	F31
MV1205-2	Filling instruments - amalgam - Ward	Asa Light MV	F31
MV1206-1	Filling instruments - plastic	Asa Light MV	F36
MV1206-2	Filling instruments - plastic	Asa Light MV	F36
MV1207-1	Filling instruments - plastic	Asa Light MV	F36
MV1207-2	Filling instruments - plastic	Asa Light MV	F36
MV1208-1	Filling instruments - plastic	Asa Light MV	F36
MV1208-2	Filling instruments - plastic	Asa Light MV	F36
MV1208-3	Filling instruments - plastic	Asa Light MV	F36
MV1209-1	Filling instruments - plastic	Asa Light MV	F36
MV1209-2	Filling instruments - plastic	Asa Light MV	F36
MV1209-3	Filling instruments - plastic	Asa Light MV	F36
MV1210-1	Filling instruments - plastic	Asa Light MV	F37
MV1210-2	Filling instruments - plastic	Asa Light MV	F37
MV1210-3	Filling instruments - plastic	Asa Light MV	F37
MV1211-0T	Filling instruments - amalgam - Tanner	Asa Light MV	F31
MV1211-1T	Filling instruments - amalgam - Tanner	Asa Light MV	F31
MV1211-2T	Filling instruments - amalgam - Tanner	Asa Light MV	F31
MV1211-3T	Filling instruments - amalgam - Tanner	Asa Light MV	F31
MV1212-01	Filling instruments - amalgam - Marquette	Asa Light MV	F31
MV1213-H1	Filling instruments - amalgam - Hollenback	Asa Light MV	F31
MV1213-H2	Filling instruments - amalgam - Hollenback	Asa Light MV	F31
MV1213-H3	Filling instruments - amalgam - Hollenback	Asa Light MV	F31
MV1213-H4	Filling instruments - amalgam - Hollenback	Asa Light MV	F31
MV1214-2	Filling instruments - Burnishers - Ladmore	Asa Light MV	F34
MV1214-3	Filling instruments - Burnishers - Ladmore	Asa Light MV	F34
MV1215-18	Filling instruments - Burnishers - Ball	Asa Light MV	F34
MV1215-27S	Filling instruments - Burnishers	Asa Light MV	F34
MV1215-29	Filling instruments - Burnishers - Ball	Asa Light MV	F34
MV1216-1	Filling instruments - plastic - Woodson	Asa Light MV	F37
MV1216-2	Filling instruments - plastic - Woodson	Asa Light MV	F37
MV1216-3	Filling instruments - plastic - Woodson	Asa Light MV	F37
MV1217-11	Filling instruments - plastic	Asa Light MV	F37
MV1218-6	Filling instruments - plastic	Asa Light MV	F37
MV1219-179	Filling instruments - plastic	Asa Light MV	F37
MV1220-B2	Filling instruments - Burnishers	Asa Light MV	F34
MV1221-31	Filling instruments - Burnishers	Asa Light MV	F34
MV1230-1	Bone compactors		E35
MV1230-2	Bone compactors		E35
MV1231-1	Bone applicator	Asa Light MV	E29
MV1301	Placement instruments	Asa Light MV	F41
MV1302	Placement instruments	Asa Light MV	F41
MV1400-1	Filling instruments - amalgam - Markley	Asa Light MV	F32
MV1400-2	Filling instruments - amalgam - Markley	Asa Light MV	F32
MV1400-3	Filling instruments - amalgam - Markley	Asa Light MV	F32
MV1400-4	Filling instruments - amalgam - Markley	Asa Light MV	F32
MV1400-5	Filling instruments - amalgam - Markley	Asa Light MV	F32
MV1400-6	Filling instruments - amalgam - Markley	Asa Light MV	F32
MV1500-02	Amalgam/wax carvers - Hollenback	Asa Light MV	F38, L13
MV1500-3	Amalgam/wax carvers - Hollenback	Asa Light MV	F38, L13
MV1500-3S	Amalgam/wax carvers - Hollenback	Asa Light MV	F38, L13
MV1501-1	Amalgam/wax carvers - Ward	Asa Light MV	F38, L13
MV1501-1S	Amalgam/wax carvers - Ward	Asa Light MV	F38, L13
MV1501-2	Amalgam/wax carvers - Ward	Asa Light MV	F38, L13
MV1502-1	Amalgam/wax carvers - Frahm	Asa Light MV	F39, L13
MV1507-8	Modeling instruments	Asa Light MV	F39
MV1600-1	Modeling instruments - cleoid-discoid	Asa Light MV	F40
MV1600-2	Modeling instruments - cleoid-discoid	Asa Light MV	F40
MV1600-3	Modeling instruments - cleoid-discoid	Asa Light MV	F40
MV1600-4	Modeling instruments - cleoid-discoid	Asa Light MV	F40
MV1601-1	Cavity preparation instruments - margin trimmers - distal - Black/26	Asa Light MV	F21
MV1601-2	Cavity preparation instruments - margin trimmers - mesial - Black/27	Asa Light MV	F21
MV1601-3	Cavity preparation instruments - margin trimmers - distal - Black/28	Asa Light MV	F21

CODE	DESCRIPTION	HANDLE	PAGE
MV1601-4	Cavity preparation instruments - margin trimmers - mesial - Black/29	Asa Light MV	F21
MV1602-1	Cavity preparation instruments - margin trimmers - distal - Black/77-78	Asa Light MV	F21
MV1602-2	Cavity preparation instruments - margin trimmers - mesial - Black/79-80	Asa Light MV	F21
MV1603-1	Cavity preparation instruments - hatchets - Black/53-54	Asa Light MV	F22
MV1603-2	Cavity preparation instruments - hatchets - Black/51-52	Asa Light MV	F22
MV1604-02	Cavity preparation instruments - chisels - Wedelstaedt	Asa Light MV	F22
MV1604-04	Cavity preparation instruments - chisels - Wedelstaedt	Asa Light MV	F22
MV1604-06	Cavity preparation instruments - chisels - Wedelstaedt	Asa Light MV	F22
MV1700-0	Excavators - spoons	Asa Light MV	F16
MV1700-1	Excavators - spoons	Asa Light MV	F16
MV1700-2	Excavators - spoons	Asa Light MV	F16
MV1700-3	Excavators - spoons	Asa Light MV	F16
MV1700-4	Excavators - spoons	Asa Light MV	F16
MV1701-1	Excavators - spoons	Asa Light MV	F16
MV1701-2	Excavators - spoons	Asa Light MV	F16
MV1702-6	Excavators - spoons	Asa Light MV	F17
MV1703-14	Excavators - spoons	Asa Light MV	F17
MV1704-17	Excavators - spoons	Asa Light MV	F17
MV1704-17W	Excavators - oval spoons	Asa Light MV	F18
MV1705-18	Excavators - spoons	Asa Light MV	F17
MV1705-18W	Excavators - oval spoons	Asa Light MV	F18
MV1706-19	Excavators - spoons	Asa Light MV	F17
MV1706-19W	Excavators - oval spoons	Asa Light MV	F18
MV1707-39	Excavators - spoons	Asa Light MV	F17
MV1709-31L	Excavators - spoons	Asa Light MV	B15, F17
MV1709-32L	Excavators - spoons	Asa Light MV	B15, F17
MV1709-33L	Excavators - spoons	Asa Light MV	B15, F17
MV1801-D	Chisels - TG	Asa Light MV	H26
MV1802-3	Chisels - Ochsenbein	Asa Light MV	H26
MV1802-4	Chisels - Ochsenbein	Asa Light MV	H26
MV1803-D	Gingivectomy knives - Kirkland	Asa Light MV	H24
MV1804-D	Gingivectomy knives - Orban	Asa Light MV	H24
MV1805-02	Curettes and Scalers - Langer	Asa Light MV	H5
MV1805-04	Curettes and Scalers - Langer	Asa Light MV	H5
MV1806-02	Curettes and Scalers	Asa Light MV	H4
MV1806-2RL	Curettes and Scalers - Columbia	Asa Light MV	H4
MV1806-4RL	Curettes and Scalers - Columbia	Asa Light MV	H4
MV1806-14	Curettes and Scalers - Columbia	Asa Light MV	H4
MV1806-412	Curettes and Scalers - Columbia	Asa Light MV	H4
MV1806-414	Curettes and Scalers - Columbia	Asa Light MV	H4
MV1807-02	Gracey curettes	Asa Light MV	H11
MV1807-04	Gracey curettes	Asa Light MV	H11
MV1807-06	Gracey curettes	Asa Light MV	H11
MV1807-08	Gracey curettes	Asa Light MV	H11
MV1807-10	Gracey curettes	Asa Light MV	H11
MV1807-11MD	Gracey curettes	Asa Light MV	H11
MV1807-12	Gracey curettes	Asa Light MV	H11
MV1807-13MD	Gracey curettes	Asa Light MV	H11
MV1807-14	Gracey curettes	Asa Light MV	H11
MV1809-1	Curettes and Scalers - Goldman-Fox	Asa Light MV	H6
MV1809-2	Curettes and Scalers - Goldman-Fox	Asa Light MV	H6
MV1809-3	Curettes and Scalers - Goldman-Fox	Asa Light MV	H6
MV1809-4	Curettes and Scalers - Goldman-Fox	Asa Light MV	H6
MV1809-5	Curettes and Scalers - Goldman-Fox	Asa Light MV	H6
MV1809-6	Curettes and Scalers - Goldman-Fox	Asa Light MV	H6
MV1809-21	Curettes and Scalers - Goldman-Fox	Asa Light MV	H6
MV1810-07	Files - Hirschfeld	Asa Light MV	H22
MV1811-37	Chisels - back-action - Rhodes	Asa Light MV	H26
MV1812-02S	Files - Sugarman	Asa Light MV	H22
MV1812-04S	Files - Sugarman	Asa Light MV	H22
MV1813-10	Files - Schluger	Asa Light MV	H22
MV1824-14	Curettes and Scalers - anterior - Indiana University	Asa Light MV	H5
MV1824-18	Curettes and Scalers - posterior - Indiana University	Asa Light MV	H5
MV1825-12	Curettes and Scalers - Mc Call	Asa Light MV	H7
MV1825-14	Curettes and Scalers - Mc Call	Asa Light MV	H7

CODE	DESCRIPTION	HANDLE	PAGE
MV1825-14S	Curettes and Scalers · Mc Call	Asa Light MV	H7
MV1825-18S	Curettes and Scalers · Mc Call	Asa Light MV	H7
MV1825-20	Curettes and Scalers · Mc Call	Asa Light MV	H7
MV1826-T03	Curettes and Scalers · Taylor	Asa Light MV	H8
MV1827-204S	Curettes and Scalers	Asa Light MV	H8
MV1829-CK6	Curettes and Scalers · Crane-Kaplan	Asa Light MV	H8
MV1830-YG08	Curettes and Scalers · Younger-Good	Asa Light MV	H8
MV1831-32	Curettes and Scalers · Jacquette	Asa Light MV	H9
MV1831-33	Curettes and Scalers · Jacquette	Asa Light MV	H9
MV1831-35	Curettes and Scalers · Jacquette	Asa Light MV	H9
MV1831-38	Curettes and Scalers · Jacquette	Asa Light MV	H9
MV1850-9A	Periosteals and Elevators · Allen	Asa Light MV	E23, H16
MV1850-GF	Periosteals and Elevators · GF Goldman-Fox	Asa Light MV	E22, H16
MV1850-M7	Periosteals and Elevators · Molt	Asa Light MV	E23, H16
MV1850-M8	Periosteals and Elevators · Molt	Asa Light MV	E23, H16
MV1850-M9	Periosteals and Elevators · Molt	Asa Light MV	E23, H16
MV1851-2	Periosteals and Elevators · Hourigan	Asa Light MV	E23, H16
MV1851-PR3	Periosteals and Elevators · Prichard	Asa Light MV	E23, H16
MV1852-1	Periosteals and Elevators · Hopkins	Asa Light MV	E24, H17
MV1852-2	Periosteals and Elevators · Hopkins	Asa Light MV	E24, H17
MV1853-15	Periosteals and Elevators · Freer	Asa Light MV	E24, H17
MV1853-16	Periosteals and Elevators · Freer	Asa Light MV	E24, H17
MV1854-3	Periosteals and Elevators · Mead	Asa Light MV	E24, H17
MV1855-1	Sinus lift instruments	Asa Light MV	E15
MV1855-2	Sinus lift instruments	Asa Light MV	E15
MV1855-3	Sinus lift instruments	Asa Light MV	E15
MV1855-4	Sinus lift instruments	Asa Light MV	E15
MV1855-5	Sinus lift instruments	Asa Light MV	E15
MV1855-6	Sinus lift instruments	Asa Light MV	E15
MV1856-1	Sinus lift instruments	Asa Light MV	E13
MV1856-2	Sinus lift instruments	Asa Light MV	E13
MV1856-3	Sinus lift instruments	Asa Light MV	E13
MV1856-4	Sinus lift instruments	Asa Light MV	E13
MV1856-5	Sinus lift instruments	Asa Light MV	E13
MV1856-6	Sinus lift instruments	Asa Light MV	E14
MV1856-7	Sinus lift instruments	Asa Light MV	E14
MV1856-8	Sinus lift instruments	Asa Light MV	E14
MV1883	Membrane placement instrument · Buser	Asa Light MV	E31
MV1902-1	Scalers · Towner Jacquette	Asa Light MV	H14
MV1902-2	Scalers · Towner Jacquette	Asa Light MV	H14
MV1904-H5	Scalers	Asa Light MV	H14
MV1904-H6	Scalers	Asa Light MV	H14
MV1905-02	Scalers	Asa Light MV	H14
MV2000-1	Bone curettes · Hemingway	Leonardo ML	C45, E21, H20
MV2000-2	Bone curettes · Hemingway	Asa Light MV	C45, E21, H20
MV2000-3	Bone curettes · Hemingway	Asa Light MV	C45, E21, H20
MV2000-4	Bone curettes · Hemingway	Asa Light MV	H20
MV2001-85	Bone curettes · Lucas	Asa Light MV	H20
MV2001-86	Bone curettes · Lucas	Asa Light MV	H20
MV2001-87	Bone curettes · Lucas	Asa Light MV	H20
MV2001-88	Bone curettes · Lucas	Asa Light MV	H20
MV2002-1	Bone files · Wahl	Asa Light MV	H23
MV2002-2	Bone files · Wahl	Asa Light MV	H23
PR0460-15TC	Needle holders · with curved jaws · Castroviejo TC		C18, E6
PR0625-2	Suture pliers		C40, E36
PR0625-3	Suture pliers		C40, E36
PR0632-1	Tissue pliers · Cooley		C38
PR1801-1	Bone chisels and gouges	Perfection	H27
PR1850-1	Periosteals and Elevators	Perfection	E24, H18
PR1850-M	Exciser · Buser	Perfection	E22, H16
PR1857-1	Exciser	Perfection	D70, E22
PR1859-1	Sinus lift instruments	Perfection	E14
PR1859-2	Sinus lift instruments	Perfection	E14
RC0700-6	Single-ended Explorers	AsaWave RC	B6
RC0700-9	Single-ended Explorers	AsaWave RC	B6

CODE	DESCRIPTION	HANDLE	PAGE
RC0700-23	Single-ended Explorers	AsaWave RC	B6
RC0702-12	Periodontal pocket Probes	AsaWave RC	E32, H3
RC0703-14	Periodontal pocket Probes	AsaWave RC	H3
RC0704-23D1	Double-ended explorers	AsaWave RC	B8
RC0707-GFW	Expros (combination explorers/probes) · Goldman-Fox Williams	AsaWave RC	B11
RC0803-1	Root canal Pluggers · Machtou	AsaWave RC	B13, G5
RC0803-2	Root canal Pluggers · Machtou	AsaWave RC	B13, G5
RC0803-3	Root canal Pluggers · Machtou	AsaWave RC	B13, G5
RC0803-4	Root canal Pluggers · Machtou	AsaWave RC	B13, G5
RC1102-1	Heidemann separating spatulas	AsaWave RC	F27
RC1102-2	Heidemann separating spatulas	AsaWave RC	F27
RC1102-3	Heidemann separating spatulas	AsaWave RC	F27
RC1200-2	Filling instruments - amalgam	AsaWave RC	F29
RC1200-3	Filling instruments - amalgam	AsaWave RC	F29
RC1200-4	Filling instruments - amalgam	AsaWave RC	F29
RC1200-5	Filling instruments - amalgam	AsaWave RC	F29
RC1202-2	Filling instruments - amalgam	AsaWave RC	F30
RC1210-1	Filling instruments - plastic	AsaWave RC	F37
RC1210-2	Filling instruments - plastic	AsaWave RC	F37
RC1210-3	Filling instruments - plastic	AsaWave RC	F37
RC1215-18	Filling instruments - Burnishers · Ball	AsaWave RC	F34
RC1215-27S	Filling instruments - Burnishers	AsaWave RC	F34
RC1510-1D	Composite instruments	AsaWave RC	F52
RC1510-2D	Composite instruments	AsaWave RC	F52
RC1510-3D	Composite instruments	AsaWave RC	F52
RC1510-4D	Composite instruments	AsaWave RC	F52
RC1510-5D	Composite instruments	AsaWave RC	F52
RC1700-1	Excavators - spoons	AsaWave RC	F16
RC1700-2	Excavators - spoons	AsaWave RC	F16
RC1700-3	Excavators - spoons	AsaWave RC	F16
RC1806-14	Curettes and Scalers · Columbia	AsaWave RC	H4
RC1806-14SF	Curettes and Scalers · Columbia · Sharpen Free	AsaWave RC	H4
RC1807-02	Gracey curettes	AsaWave RC	H11
RC1807-02SF	Gracey curettes · Sharpen Free	AsaWave RC	H11
RC1807-04	Gracey curettes	AsaWave RC	H11
RC1807-04SF	Gracey curettes · Sharpen Free	AsaWave RC	H11
RC1807-06	Gracey curettes	AsaWave RC	H11
RC1807-06SF	Gracey curettes · Sharpen Free	AsaWave RC	H11
RC1807-08	Gracey curettes	AsaWave RC	H11
RC1807-08SF	Gracey curettes · Sharpen Free	AsaWave RC	H11
RC1807-10	Gracey curettes	AsaWave RC	H11
RC1807-10SF	Gracey curettes · Sharpen Free	AsaWave RC	H11
RC1807-12	Gracey curettes	AsaWave RC	H11
RC1807-12SF	Gracey curettes · Sharpen Free	AsaWave RC	H11
RC1807-14	Gracey curettes	AsaWave RC	H11
RC1807-14SF	Gracey curettes · Sharpen Free	AsaWave RC	H11
RC1807-16	Gracey curettes	AsaWave RC	H11
RC1807-16SF	Gracey curettes · Sharpen Free	AsaWave RC	H11
RC1807-18	Gracey curettes	AsaWave RC	H11
RC1807-18SF	Gracey curettes · Sharpen Free	AsaWave RC	H11
RC1825-14	Curettes and Scalers · Mc Call	AsaWave RC	H7
RC1825-14S	Curettes and Scalers · Mc Call	AsaWave RC	H7
RC1825-14SSF	Curettes and Scalers · Mc Call · Sharpen Free	AsaWave RC	H7
RC1827-204S	Curettes and Scalers	AsaWave RC	H8
RC1827-204SSF	Curettes and Scalers · Sharpen Free	AsaWave RC	H8
RC1829-CK6	Curettes and Scalers · Crane-Kaplan	AsaWave RC	H8
RC1829-CK6S	Curettes and Scalers · Mini Crane-Kaplan	AsaWave RC	H8
RC1829-CK6SF	Curettes and Scalers · Crane-Kaplan · Sharpen Free	AsaWave RC	H8
RC1829-CK6SSF	Curettes and Scalers · Mini Crane-Kaplan · Sharpen Free	AsaWave RC	H8
RC1900-M23	Scalers · Universal Scaler	AsaWave RC	H14
RC1900-M23SF	Scalers · Universal Scaler · Sharpen Free	AsaWave RC	H14
RC1902-1	Scalers · Towner Jacquette	AsaWave RC	H14
RC1902-2	Scalers · Towner Jacquette	AsaWave RC	H14
RC1902-1SF	Scalers · Towner Jacquette · Sharpen Free	AsaWave RC	H14

CODE	DESCRIPTION	HANDLE	PAGE
RC1902-2SF	Scalers · Towner Jacqueline · Sharpen Free	AsaWave RC	H14
RC1904-H5	Scalers	AsaWave RC	H14
RC1904-H5SF	Scalers · Sharpen Free	AsaWave RC	H14
RC1904-H6	Scalers	AsaWave RC	H14
RC1904-H6SF	Scalers · Sharpen Free	AsaWave RC	H14
RC2001-85	Bone curettes · Lucas	AsaWave RC	H20
RC2001-86	Bone curettes · Lucas	AsaWave RC	H20
RC2001-87	Bone curettes · Lucas	AsaWave RC	H20
RC2001-88	Bone curettes · Lucas	AsaWave RC	H20
RC2101	Simple stem Mouth Mirrors - Handles	AsaWave RC	B19
S0100-1	Extracting forceps		D4
S0100-2	Extracting forceps		D5
S0100-3	Kit for extraction and oral surgery		D72
S0100-4	Kit for extraction and oral surgery		D72
S0110	Extracting forceps for children		D38
S0112	Extracting forceps for children · Klein		D39
S0200-6	Root elevators		D49
S0200-10	Root elevators		D51
S0244-6	Root elevators		D52
S0280-4	Ideal · Elevator kit of 4 pcs		D47
S0296-1	Syndesmotomes instruments kit		D71
S0296	Syndesmotomes instruments kit		D71
S0352	Scalpel handle and remover kit		C24, E9
S0495-6	Osteotomes		E19
S0498-8	Implant surgery instruments · mini sinus lift kit		E40
S0600-1	Periodontal first examination kit		H36
S0600-6	Instrument kit for first examinations		B22
S0600-9	Instrument kit for first examinations		B22
S0600-23	Instrument kit for first examinations		B22
S0601-1	Cotton and dressing pliers · Flagg		B4
S0601-2	Cotton and dressing pliers · London-College		B4
S0601-3	Cotton and dressing pliers · Meriam		B4
S0645	Tissue pliers set		C42
S0690-2	Ultralight Retractor		B21
S0700-6	Single-ended Explorers		B7
S0700-9	Single-ended Explorers		B7
S0700-11	Single-ended Explorers		B7
S0700-16	Single-ended Explorers		B7
S0700-23	Single-ended Explorers		B7
S0702L-7	Kit for endodontics · 7 Laser System instruments		B24
S0702L-23	Kit for endodontics · Boston university		B25
S0800	Kit for endodontics		B24
S0903-1	Cement spatulas		F25
S0903-2	Cement spatulas		F25
S0903-3	Cement spatulas		F25
S1102-1	Heidemann separating spatulas		F27
S1102-2	Heidemann separating spatulas		F27
S1102-3	Heidemann separating spatulas		F27
S1200-1	Filling instruments - amalgam		F29
S1200-2	Filling instruments - amalgam		F29
S1200-3	Filling instruments - amalgam		F29
S1200-4	Filling instruments - amalgam		F29
S1200-5	Filling instruments - amalgam		F29
S1200T	Filling instruments - amalgam		F28
S1222-7	Composite instruments		F53
S1222-15	Composite instruments		F53
S1400	Filling instruments - amalgam · Markley		F32
S1700-0	Excavators - spoons		F16
S1700-1	Excavators - spoons		F16
S1700-2	Excavators - spoons		F16
S1700-3	Excavators - spoons		F16
S1700-4	Excavators - spoons		F16
S1700	Excavators - spoons		F16
S1710-6	Excavators · SS. White		F19
S1800-23	Instrument kit for periodontics		H37

CODE	DESCRIPTION	HANDLE	PAGE
S1806	Curettes and Scalers		H4
S1807-3	Gracey curettes		H34
S1807	Gracey curettes		H34
S1807AF-3	Gracey curettes		H34
S1807AF	Gracey curettes		H34
S1807MF-3	Gracey curettes		H34
S1807MF	Gracey curettes		H34
S1809	Curettes and Scalers		H6
S1890	Grinding stones		H33
S1899	Instrument kit for periodontics		H35
S2002-6	Mirrors (mouth) parallelometer with handle	Asa60	B19
S2100	Simple stem Mouth Mirrors - Handles · set of 5		B19
S2101	Simple stem Mouth Mirrors - Handles · set of 5		B19
S2102-IN	Simple stem Mouth Mirrors - Handles · set of 5, hollow		B19
S2700	Stainless steel instrument trays · for 7 instruments		J6
S2702	Stainless steel instrument trays · for 7 instruments		J6
S2720-1	Stainless steel instrument trays · for 16 instruments		J5
S2720-2	Stainless steel instrument trays · for 23 instruments		J5
S2721-1	Stainless steel instrument trays · for 16 instruments		J4
S2721-2	Stainless steel instrument trays · for 23 instruments		J4
S2722-1	Stainless steel instrument trays · for 16 instruments		J4
S2722-2	Stainless steel instrument trays · for 23 instruments		J4
S2723-1	Stainless steel instrument trays · for 8 instruments		J6
S2723-2	Stainless steel instrument trays · for 4 instruments		J6
S2724-1	Stainless steel instrument trays · for 8 instruments		J7
S2724-2	Stainless steel instrument trays · for 4 instruments		J7
S2731-1	Stainless steel dental dam clamp tray with 8 different clamps		F14
S2731-12	Stainless steel dental dam clamp tray with 12 different clamps		F14
S2760-A	Colored silicone bur holders · Orange		E34, J19
S2760-C	Colored silicone bur holders · Blue		E34, J19
S2780-IMP	Implant surgery instruments		E39
S2800-12	Perforated aluminum impression trays		K38
S2801-6	Perforated stainless steel impression trays		K12
S2801-8	Perforated stainless steel impression trays		K12
S2801-12	Perforated stainless steel impression trays		K12
S2801A-6	Perforated stainless steel impression trays - anatomic		K14
S2801A-8	Perforated stainless steel impression trays - anatomic		K14
S2801A-12	Perforated stainless steel impression trays - anatomic		K14
S2802-6	Non-perforated stainless steel impression trays		K34
S2802-8	Non-perforated stainless steel impression trays		K34
S2802-12	Non-perforated stainless steel impression trays		K34
S2802A-6	Non-perforated stainless steel impression trays - anatomic		K36
S2802A-8	Non-perforated stainless steel impression trays - anatomic		K36
S2802A-12	Non-perforated stainless steel impression trays - anatomic		K36
S2803-10	Non-perforated stainless steel impression trays - NEW SUPER		K22
S2803S-10	Non-perforated stainless steel impression trays - NEW SUPER high grip		K32
S2804-6	Perforated stainless steel impression trays - PERMA-LOCK		K4
S2804-8	Perforated stainless steel impression trays - PERMA-LOCK		K4
S2804-12	Perforated stainless steel impression trays - PERMA-LOCK		K4
S2804A-6	Perforated stainless steel impression trays - PERMA-LOCK anatomic		K6
S2804A-8	Perforated stainless steel impression trays - PERMA-LOCK anatomic		K6
S2804A-12	Perforated stainless steel impression trays - PERMA-LOCK anatomic		K6
S2804S-6	Perforated stainless steel impression trays - PERMA-LOCK high grip		K8
S2804S-8	Perforated stainless steel impression trays - PERMA-LOCK high grip		K8
S2804S-12	Perforated stainless steel impression trays - PERMA-LOCK high grip		K8
S2806-8	Perforated stainless steel impression trays - edentulous		K11
S2807-6	Non-perforated stainless steel impression trays - PERMA-LOCK		K24
S2807-8	Non-perforated stainless steel impression trays - PERMA-LOCK		K24
S2807-12	Non-perforated stainless steel impression trays - PERMA-LOCK		K24
S2807A-6	Non-perforated stainless steel impression trays - PERMA-LOCK anatomic		K26
S2807A-8	Non-perforated stainless steel impression trays - PERMA-LOCK anatomic		K26
S2807A-12	Non-perforated stainless steel impression trays - PERMA-LOCK anatomic		K26
S2807S-6	Non-perforated stainless steel impression trays - PERMA-LOCK high grip		K28
S2807S-8	Non-perforated stainless steel impression trays - PERMA-LOCK high grip		K28
S2807S-12	Non-perforated stainless steel impression trays - PERMA-LOCK high grip		K28

CODE	DESCRIPTION	HANDLE	PAGE
S2808-8	Non-perforated stainless steel impression trays - edentulous		K31
S2809-6	Perforated stainless steel impression trays - anterior depressed		K10
S2810-6	Non-perforated stainless steel impression trays - anterior depressed		K30
S2811-1	Perforated stainless steel impression trays · Ehricke		K16
S2811-2	Perforated stainless steel impression trays · Ehricke		K16
S2811-3	Perforated stainless steel impression trays · Ehricke		K18
S2811-4	Perforated stainless steel impression trays · Ehricke		K19
S2813	Perforated stainless steel impression trays - edentulous		K20
S2816-6	Perforated aluminum impression trays - ORTHOBABY for children		K42
S2851-24	Polycarbonate impression trays - edentulous		K48
S2880-12	Perforated aluminum impression trays for implantology		K40
S2880-12FR	Perforated aluminum impression trays for implantology		K40
S3000	Dental dam instrument kit		F13
S3001-20	Implant surgery instruments · Goracci kit		E40
S3002-13	Instrument kit for oral surgery		C46
S3002-17	Instrument kit for oral surgery		C46
S3002-18	Instrument kit for oral surgery		C47
S3003-9	Implant surgery instruments		E41, H36
S3003-11	Implant surgery instruments		E41, H37
S5112	Amalgam/wax carvers		L17
S5112AL	Amalgam/wax carvers		L17
S5160	Waxing instruments with replaceable tips		L18
S5160-1C	Waxing instruments with replaceable tips	Alu80	L18
S5160-2C	Waxing instruments with replaceable tips	Alu80	L18
S5160-3C	Waxing instruments with replaceable tips	Alu80	L18
S5800	Pliers tray		J14
S6810-1	Orthodontic Lab Set		L35
S6810-2	Orthodontic Lab Set		L35
S6811-2	Orthodontic Lab Set		L34
SLV1807	Gracey curettes		H34
SLV1807AF	Gracey curettes		H34
SLV1807MF	Gracey curettes		H34
SML1710-6	Excavators · SS. White		F19
SML1807	Gracey curettes		H34
SML1807AF	Gracey curettes		H34
SML1807MF	Gracey curettes		H34
SML2021CF	Apical micro endo kit - Full		G12
SML2021FP	Apical micro endo kit - Essential		G8
SMV1400	Filling instruments - amalgam · Markley		F32
SMV1700	Excavators - spoons		F16
SMV1806	Curettes and Scalers		H4
SMV1807	Gracey curettes		H34
SMV1809	Curettes and Scalers		H6
SPR0495	Implant surgery instruments · mini sinus lift kit		E39
SPR0496	Implant surgery instruments · maxi sinus lift kit		E38
SPR2781-I	Kit for implant surgery		E38
SPR2781-P	Instrument kit for periodontology		H36
SPR2781-S	Kit for oral surgery		D72
SRC0600-6	Instrument kit for first examinations - AsaWave	AsaWave RC	B23
SRC0600-9	Instrument kit for first examinations - AsaWave	AsaWave RC	B23
SRC0600-23	Instrument kit for first examinations - AsaWave	AsaWave RC	B23
SRC1807	Gracey curettes	AsaWave RC	H34
SVS2731-6	Vision® Shade · stainless steel magnetic locking tray with 6 clamps		F3
SVS3000	Vision® Shade kit		F5
SWML0600-6	Instrument kit for first examinations - AsaLady		B22
SWML0600-9	Instrument kit for first examinations - AsaLady		B22
SWML0600-23	Instrument kit for first examinations - AsaLady		B22
VS3045	Vision® Shade · pack of 60 dental dams (black, mint-flavored dams)		F3
VS3051-210	Vision® Shade · winged clamp		F4
VS3052-2	Vision® Shade · winged clamp		F4
VS3052-12A	Vision® Shade · winged, serrated clamp		F4
VS3052-13A	Vision® Shade · winged, serrated clamp		F4
VS3052-W4	Vision® Shade · wingless clamp		F4
VS3052-W8	Vision® Shade · wingless clamp		F4
VV2731-6	Vision® Shade · stainless steel magnetic locking tray without clamps		F3

CODE	DESCRIPTION	HANDLE	PAGE
VV3030	Vision® Shade · stainless steel clamp forceps		F4
VV3033	Vision® Shade · stainless steel punch forceps		F4
VV3035	Vision® Shade · stainless steel punching template		F5
VV3040-2	Vision® Shade · stainless steel dam frame 100x150 mm		F3
VVPEN	Vision® Shade · food-safe marker		F5
W0121-5	Extracting forceps - American pattern, AsaLady · Physick		D29
W0121-6	Extracting forceps - American pattern, AsaLady		D29
W0121-10S	Extracting forceps - American pattern, AsaLady		D29
W0121-16	Extracting forceps - American pattern, AsaLady		D29
W0121-17	Extracting forceps - American pattern, AsaLady		D29
W0121-18L	Extracting forceps - American pattern, AsaLady · Harris		D30
W0121-18R	Extracting forceps - American pattern, AsaLady · Harris		D30
W0121-23	Extracting forceps - American pattern, AsaLady		D30
W0121-53L	Extracting forceps - American pattern, AsaLady		D30
W0121-53R	Extracting forceps - American pattern, AsaLady		D30
W0121-65	Extracting forceps - American pattern, AsaLady		D31
W0121-69	Extracting forceps - American pattern, AsaLady · Tomes		D31
W0121-88L	Extracting forceps - American pattern, AsaLady · Nevius		D31
W0121-88R	Extracting forceps - American pattern, AsaLady · Nevius		D31
W0121-101	Extracting forceps - American pattern, AsaLady · Hull		D31
W0121-150	Extracting forceps - American pattern, AsaLady · Cryer		D32
W0121-150S	Extracting forceps - American pattern, AsaLady · Cryer		D32
W0121-151	Extracting forceps - American pattern, AsaLady · Cryer		D32
W0121-151S	Extracting forceps - American pattern, AsaLady · Cryer		D32
W0121-222	Extracting forceps - American pattern, AsaLady		D32
W0160-1	Extracting forceps - AsaLady		D21
W0160-2	Extracting forceps - AsaLady		D21
W0160-4	Extracting forceps - AsaLady		D21
W0160-7	Extracting forceps - AsaLady		D21
W0160-13	Extracting forceps - AsaLady		D21
W0160-17	Extracting forceps - AsaLady		D21
W0160-18	Extracting forceps - AsaLady		D21
W0160-21	Extracting forceps - AsaLady		D22
W0160-22	Extracting forceps - AsaLady		D22
W0160-33	Extracting forceps - AsaLady		D22
W0160-45	Extracting forceps - AsaLady		D22
W0160-51A	Extracting forceps - AsaLady		D22
W0160-67A	Extracting forceps - AsaLady		D22
W0160-74	Extracting forceps - AsaLady		D22
W0160-79	Extracting forceps - AsaLady		D23
W0160-86C	Extracting forceps - AsaLady		D23
W0160-145	Extracting forceps - AsaLady		D23
W0160-151/	Extracting forceps - AsaLady		D23
W0298-3	Syndesmotomes - AsaLady · Chompret		D67
W0319-1	Gum scissors - AsaLady · straight		C3
W0319-2	Gum scissors - AsaLady · curved		C3
W0349-3	Scalpel handles - AsaLady		C26, E7
W0411-15	Needle holders - AsaLady · Crile-Wood		C11
W0411-15TC	Needle holders - AsaLady · Crile-Wood TC		C11
W0412-16	Needle holders - AsaLady · Mayo-Hegar		C12
W0412-16TC	Needle holders - AsaLady · Mayo-Hegar		C12
W0502-1	Hemostats - AsaLady · straight · Halstead-Mosquito		C21
W0502-2	Hemostats - AsaLady · curved · Halstead-Mosquito		C21
W0610-1	Cotton and dressing pliers - AsaLady · Flagg		B5
W0610-2	Cotton and dressing pliers - AsaLady · London College		B5
W0610-3	Cotton and dressing pliers - AsaLady · Meriam		B5
W3035	Clamp forceps - AsaLady · Ivory lightweight		F12
W3036	Punching forceps - AsaLady · Ainsworth		F11
WML1102-1	Heidemann separating spatulas - AsaLady	Leonardo ML	F27
WML1102-2	Heidemann separating spatulas - AsaLady	Leonardo ML	F27
WML1102-3	Heidemann separating spatulas - AsaLady	Leonardo ML	F27
WML1401-0	Filling instruments - amalgam · Foc	Leonardo ML	F33
WML1401-1	Filling instruments - amalgam · Foc	Leonardo ML	F33

©2025 ASA DENTAL S.P.A.

This catalog may contain typographical errors, inaccuracies or omissions that may relate to product descriptions, specifications, dimensions, quantities, configurations and other details.

Asa Dental cannot assume any legal liability or responsibility for the accuracy or completeness of the information provided, that is intended for general guidance only.

Asa Dental reserves the right to change, replace or discontinue products without prior notice in order to improve technical features or quality.

We recommend regularly checking our website and considering it the most reliable source of up-to-date information regarding product availability, specifications, technical procedures and instructions for use.

As an alternative, you can contact our customer care.

Use of pictures, drawings and symbols available in this catalogue is subject to approval from Asa Dental and may be used only as support for advertising and promotional material of the Company and its products.

Asa Dental, AsaOne, AsaLady, AsaFresh, AsaLight, Perfection, Vision, Leonardo, Leonardo Light, AsaWave, Asa Codicolor, Perma-Lock are all registered trademarks of Asa Dental.

HEAD OFFICE

Asa Dental S.p.A.

Via Valenzana di Sopra, 60 - Bozzano
55054 Massarosa (Lu) - Italy
Tel. +39 0584 938305 - 93363 - 938306
Fax +39 0584 937167
asadental@asadental.it

LOGISTICS CENTER

Via Sarzanese Valdera, 1331 - Bozzano
55054 Massarosa (Lu) - Italy

PRODUCTION PLANTS

Via delle Piagge, 1/A - Marlia
55014 Capannori (Lu) - Italy

Via Fierla, 13 - Z.I.
33085 Maniago (Pn) - Italy

BRANCH OFFICES

Asa Dental USA Corp.

105 Maxess Road, Suite 124
Melville, New York 11747 - USA

Asa Dental CHINA CO. LTD.

Room 315, Huaying Building,
Zhong Xin Avenue
Tianjin Airport Economic Area
Tianjin - China

Asa Dental S.p.A. (Branch)

Shahrazad Afdal Bahati Bldg.
Parcel 345-826
Bur Dubai
PO Box 414299
Dubai - UAE

www.asadental.com

